

IND9D57/Dyn-570

Dynamic Weighing Controller



METTLER TOLEDO

IND9D57/Dyn-570

Dynamic Weighing System

METTLER TOLEDO Service

Essential Services for Dependable Performance of Your IND9D57/Dyn-570 Dynamic Weighing System

Congratulations on choosing the quality and precision of METTLER TOLEDO. Proper use of your new equipment according to this Manual and regular calibration and maintenance by our factory-trained service team ensures dependable and accurate operation, protecting your investment. Contact us about a service agreement tailored to your needs and budget. Further information is available at www.mt.com/service.

There are several important ways to ensure you maximize the performance of your investment:

1. **Register your product:** We invite you to register your product at www.mt.com/productregistration so we can contact you about enhancements, updates and important notifications concerning your product.
2. **Contact METTLER TOLEDO for service:** The value of a measurement is proportional to its accuracy – an out of specification scale can diminish quality, reduce profits and increase liability. Timely service from METTLER TOLEDO will ensure accuracy and optimize uptime and equipment life.
 - a. **Installation, Configuration, Integration and Training:** Our service representatives are factory-trained, weighing equipment experts. We make certain that your weighing equipment is ready for production in a cost effective and timely fashion and that personnel are trained for success.
 - b. **Initial Calibration Documentation:** The installation environment and application requirements are unique for every industrial scale so performance must be tested and certified. Our calibration services and certificates document accuracy to ensure production quality and provide a quality system record of performance.
 - c. **Periodic Calibration Maintenance:** A Calibration Service Agreement provides on-going confidence in your weighing process and documentation of compliance with requirements. We offer a variety of service plans that are scheduled to meet your needs and designed to fit your budget.
 - d. **GWP® Verification:** A risk-based approach for managing weighing equipment allows for control and improvement of the entire measuring process, which ensures reproducible product quality and minimizes process costs. GWP (Good Weighing Practice), the science-based standard for efficient life-cycle management of weighing equipment, gives clear answers about how to specify, calibrate and ensure accuracy of weighing equipment, independent of make or brand.

Contents

1	Overview	1-1
1.1.	Cyclic Sample Overview	1-1
1.2.	Shared Data Access Sample Overview	1-3
1.3.	Basic Configuration	1-3
1.3.1.	Application	1-3
1.3.2.	Terminal	1-5
1.3.3.	Communications	1-6
2	EtherNet/IP	2-1
2.1.	PLC Configuration	2-1
2.2.	IND9D57 Setup	2-2
2.2.1.	Communications	2-2
3	ControlNet	3-1
3.1.	PLC Configuration	3-1
3.2.	IND9D57 Setup	3-2
3.2.1.	Communications	3-2
4	DeviceNet	4-1
4.1.	PLC Configuration	4-1
4.2.	IND9D57 Setup	4-3
4.2.1.	Communications	4-3
5	PROFIBUS	5-1
5.1.	PLCs used for samples	5-1
5.2.	Notes on Shared Data Access with PROFIBUS	5-1
5.3.	IND9D57 Cyclic Data Access Setup in the PLC	5-3
5.3.1.	IND9D57 Setup Menu	5-4
5.4.	IND9D57 Shared Data Access Setup in the PLC	5-5
5.4.1.	IND9D57 Setup Menu	5-7
6	PROFINET	6-1
6.1.	PLCs used for samples	6-1
6.2.	Notes on Shared Data Access with PROFINET	6-1
6.2.1.	Shared Data Writes	6-1
6.2.2.	Shared Data Reads	6-2
6.3.	IND9D57 Setup in the PLC	6-3
6.4.	IND9D57 Setup Menu	6-4
6.4.1.	Communications	6-4

1 Overview

This document provides the configuration requirements of the IND9D57 unit that will allow it to work with the provided PLC sample code.

The sample code is divided two ways:

1. By Fieldbus. The fieldbuses demonstrated are:
 - a. Ethernet/IP
 - b. ControlNet
 - c. DeviceNet
 - d. PROFIBUS
 - e. PROFINET
2. By the type of messaging used
 - a. Cyclic (all 5 fieldbuses)
 - b. Shared Data Access, which is typically accomplished with Acyclic or Explicit messaging, with the following notes:
 - i. DeviceNet has no Acyclic/Explicit messaging capability
 - ii. PROFIBUS is also handled entirely with Cyclic messages. However, a method of accessing Shared Data in the terminal is provided with the terminal, and is used for this sample.

1.1. Cyclic Sample Overview

The cyclic data samples have simpler PLC logic because they take advantage of the cyclic data link between the PLC and the IND957D. But to do this, they require that Outputs 3, 4, and 5 on the IND9D57 be wired back into Input 3 as shown below, so that a new Processed Weight reading, or an error, will trigger the PLC program to go read the current value of the Floating Point data being returned to the PLC.

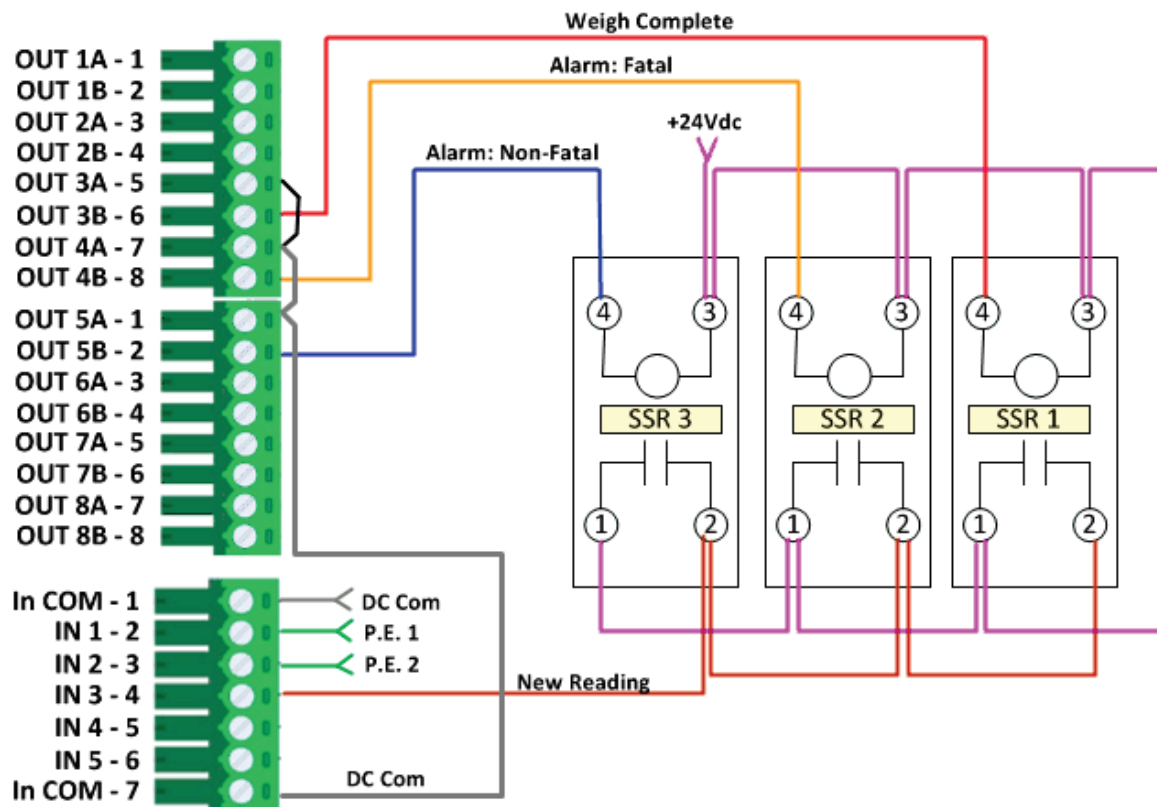

Notes:

1. The Active/Passive switch should be in the 'Passive' position.
2. The Solid State Relays (SSR) shown are Crouzet GDS-ODC (84130104)

Figure 1-1: IND570 Dynamic Weighing – Cyclic Data I/O Wiring

The cyclic data sample programs take advantage of the fact that IND9D57 puts the most recent Processed Weight captured into Shared Data Variable AJ0101.

The sample program sends Floating Point Command 17 to the IND9D57, which causes the terminal to return the value for Shared Data Variable AJ0101 in the Floating Point data. The floating point data can then be read when a new Processed Weight is detected (Input 3 goes high) to capture the new Processed Weight.

If the Processed Weight read is a negative value, then this indicates that an error has occurred, and the value returned in the Floating Point data is an error code indicating what the error was.

The IND9D57 also returns an Over/Under/OK status in the Cyclic Data Scale Status word using the Feed, Fast Feed, and Tolerance OK status bits as follows:

- Feed = Under Target Value
- Fast Feed = Value OK
- Tolerance OK = Over Target Value.

1.2. Shared Data Access Sample Overview

Because the Shared Data Access samples can monitor all of the IND9D57's I/O, no additional wiring of the unit is required. However, the PLC logic tends to be more complicated so that it can handle the various methods for Shared Data Access.

The PLC does a composite read of all of the IND9D57's I/O so that the states of the unit's inputs and outputs come back into the PLC about 10 times per second.

The PLC monitors the returned status bit for Output 3. When that bit goes high, the IND9D57 is indicating that a new Processed Weight is available. This triggers the PLC to read Shared Data Variable IW0103 and record this as the Processed Weight.

The PLC also monitors the returned status bits for Outputs 4 and 5, which are the Fatal and Non-Fatal Errors respectively. If either of these bits go high then the error code is read from Shared Data Variable AJ0101.

After a Processed Weight has been Read by the PLC, the Over/Under/Okay status may be read by the PLC by triggering reads of the Shared Data Variables AS0109 (Over), AS0110 (Okay), and AS0111 (Under). The PLC then sets the appropriate Over/Under/Ok flags depending on the results of these reads.

1.3. Basic Configuration

The following Setup configuration of the IND9D57 terminal is recommended for use with the PLC Sample Code. Your actual configuration may vary.

Note that the configuration for the PLC interface is included in the sections for each Interface.

1.3.1. Application

1.3.1.1. Memory

1.3.1.1.1. Target Table

Mode = Over/Under

Tolerance Type = Target Deviation

Totalization = Disabled

1.3.1.2. Operation

1.3.1.2.1. Target

Source = Average Weight

Motion Check = Disabled

1.3.1.2.2. Comparators

No Comparators are defined.

- 1.3.1.2.3. Totalization
 - Mode = None.**
- 1.3.1.2.4. ID1
 - ID1 Mode = Disabled.**
- 1.3.1.2.5. ID2
 - ID2 Mode = Disabled.**
- 1.3.1.2.6. ID3
 - ID3 Mode = Disabled.**
- 1.3.1.2.7. ID4
 - ID4 Mode = Disabled.**
- 1.3.1.3. Discrete I/O**
 - 1.3.1.3.1. Inputs
 - 0.1.4 = Silence Alarm**
 - 1.3.1.3.2. Outputs
 - 0.1.1 = Running**
 - 0.1.2 = Scale Empty**
 - 0.1.3 = Weigh Complete**
 - 0.1.4 = Alarm Fatal**
 - 0.1.5 = Alarm Non-Fatal**
- 1.3.1.4. PAC**
 - 1.3.1.4.1. System
 - System Type = Checkweigh**
 - Transmit PE3 = Disabled**
 - Transmit Delay = 0 Seconds**
 - Reject = Disabled**
 - 1.3.1.4.2. Display
 - Display Time = 2 Seconds**
 - Display Info = Literal**
 - Display Literal = Processed Weight**
 - 1.3.1.4.3. Photoeyes
 - PE 1 Timer = 150 mS**
 - PE 2 Timer = 50 mS**
 - PE1 to PE2 Timer = 3 Seconds**
 - PE1 & PE2 Maximum = 5 Seconds**

- 1.3.1.4.4. WeighTime & Autotune
 - Weigh Time = 300 mS**
 - No Autotune needs to be run for the PLC sample code to work.**
- 1.3.1.4.5. Dynamic Adjust
 - Dynamic Adjust = Disabled**
- 1.3.1.4.6. Config Error
 - Log Errors = Enabled**
 - Send Error Code = Enabled**
 - Error String =**
- 1.3.1.4.7. ID1 Input
 - Data Type = None**
- 1.3.1.4.8. ID2 Input
 - Data Type = None**
- 1.3.1.4.9. Alarm Outputs
 - Fatal Alarm Output = Enabled**
 - Non-Fatal Alarm Output = Enabled**
 - Auto-clear Alarms = Enabled**
- 1.3.1.4.10. DYN Target Table
 - Function not required for configuration**
- 1.3.1.4.11. Assign I/O
 - No need to use this function if above configuration is followed.**
- 1.3.1.5. TaskExpert**
 - 1.3.1.5.1. Start

Task File Name	Auto Start
1 Dyn_Adv.cpt	Enabled
 - 1.3.1.5.2. Custom Setup
 - No Configuration**
- 1.3.2. Terminal**
 - 1.3.2.1. Softkeys**
 - Softkey 1 = Dynamic Start**
 - Softkey 2 = Target Table**

1.3.3. Communications

1.3.3.1. Connections

Port Assignment

COM1 = Continuous Output

COM1 = CTPZ Input

1.3.3.2. Serial

1.3.3.2.1. COM1

Baud = 9600

Data Bits = 8

Parity = None

Flow Control = None

Interface = RS-232

2 EtherNet/IP

2.1. PLC Configuration

The PLC used for the Ethernet/IP samples is an Allen-Bradley ControlLogix L-71 processor with a 1756-ENBT module used for interfacing with the Ethernet/IP network. The sample logic was written using RSLogix5000, Version 20, which can easily be upgraded to the newer versions of Studio5000.

To set up communication between the PLC and the IND9D57, use the IND570 AOP as shown below:

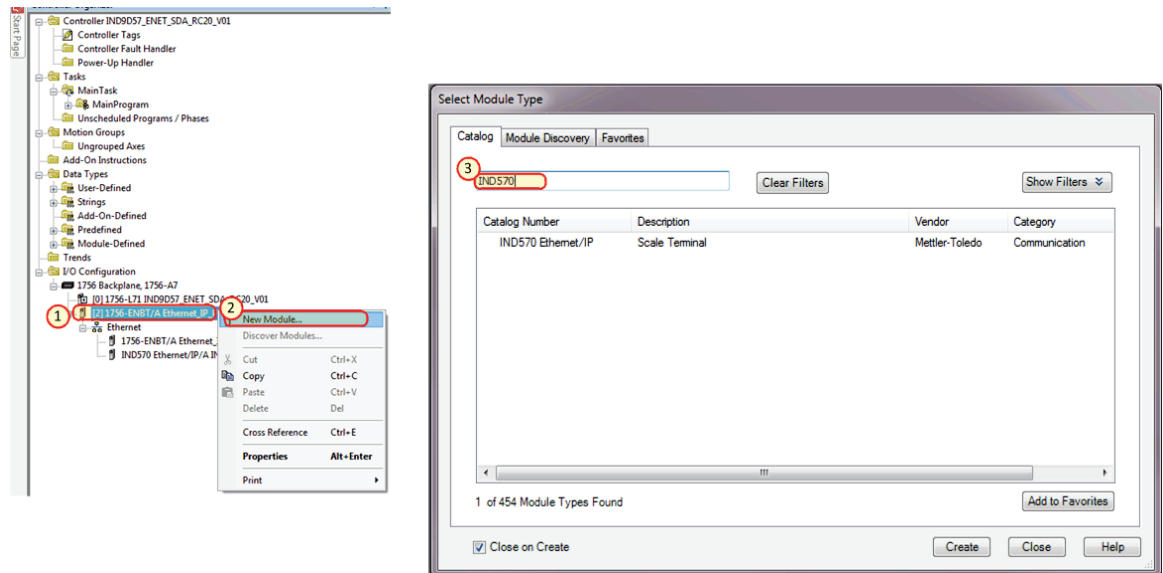

Figure 2-1: Module Setup

1. Right Click on the Ethernet/IP Bridge Module.
2. Select "New Module"
3. Type "IND570" into the search box, then double-click on the IND570 AOP in the search results.

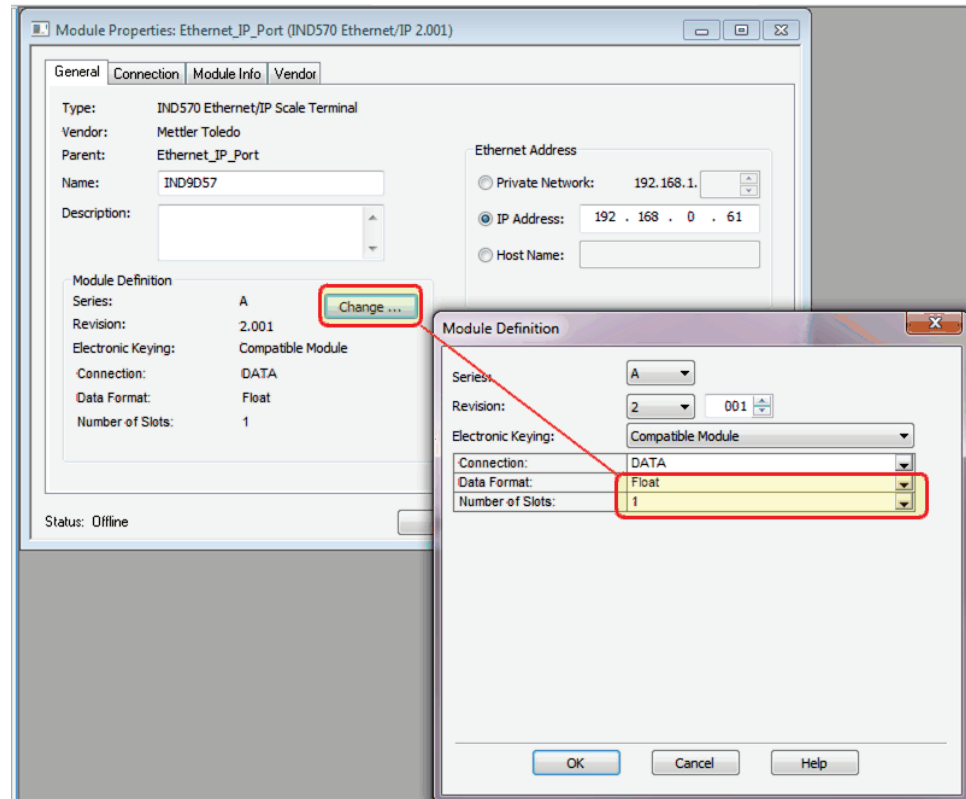

Figure 2-2: Module Definition

2.2. IND9D57 Setup

2.2.1. Communications

2.2.1.1. PLC configuration

2.2.1.1.1. Ethernet/IP

DHCP Client = Disabled

IP Address = 192.168.0.61

Subnet Mask = 255.255.255.0

Gateway = 0.0.0.0

2.2.1.1.2. Data Format

Operating Mode = Compatibility Mode

Format = Floating Point

Byte Order = Word Swap

Message Slots = 1

3 ControlNet

3.1. PLC Configuration

The PLC used for the ControlNet samples is an Allen-Bradley ControlLogix L-71 processor with a 1756-CNBR module used for interfacing with the ControlNet network. The sample logic was written using RSLogix5000, Version 20, which can easily be upgraded to the newer versions of Studio5000.

The IND9D57 uses a Generic ControlNet Module in the PLC, which is configured as follows:

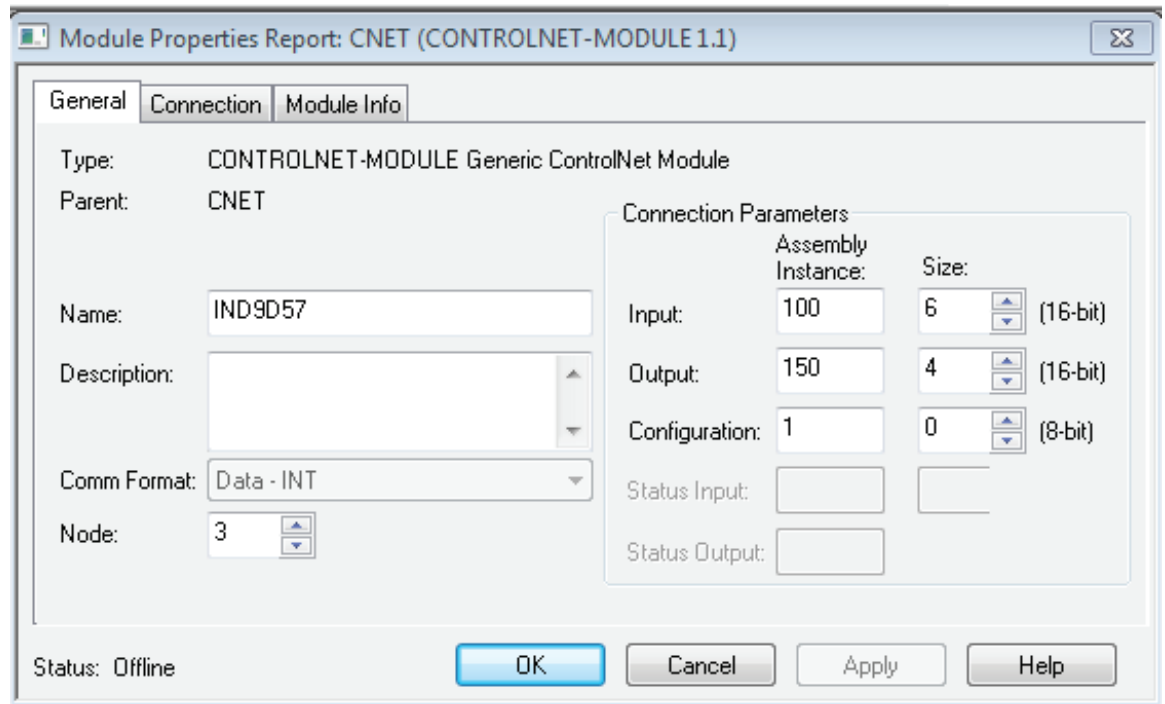

Figure 3-1: Module Properties

ControlLogix requires additional configuration using RSNetworkx for ControlNet. A configuration file named Test.xc is included with the sample code. The connection must be scheduled by RSNetworkx before the PLC will communicate with the IND9D57.

3.2. IND9D57 Setup

3.2.1. Communications

3.2.1.1. PLC configuration

3.2.1.1.1. ControlNet

Node Address = 3

3.2.1.1.2. Data Format

Operating Mode = Compatibility Mode

Format = Floating Point

Byte Order = Word Swap

Message Slots = 1

4 DeviceNet

DeviceNet does not have Acyclic messaging capability, or any way to allow the PLC to access Shared Data within the IND9D57. So, there is only a Cyclic Data example.

4.1. PLC Configuration

The PLC used for the DeviceNet samples is an Allen-Bradley ControlLogix L-71 processor with a 1756-DNB module used for interfacing with the DeviceNet network. The sample logic was written using RSLogix5000, Version 20, which can easily be upgraded to the newer versions of Studio5000.

The 1756-DNB module is configured as follows:

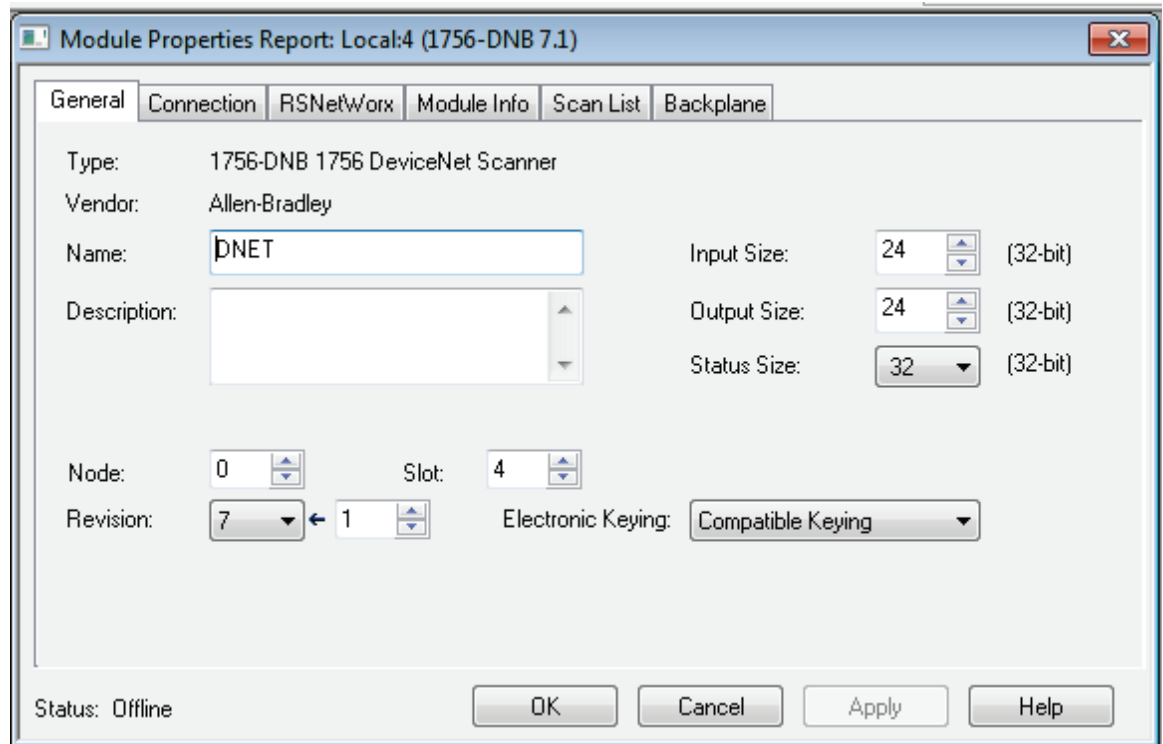

Figure 4-1: 1756-DNB Module Configuration

DeviceNet requires additional configuration using RSNetworx for DeviceNet. A configuration file named DNET.dnt is included with the sample code. The connection must be set up by RSNetworx before the PLC will communicate with the IND9D57.

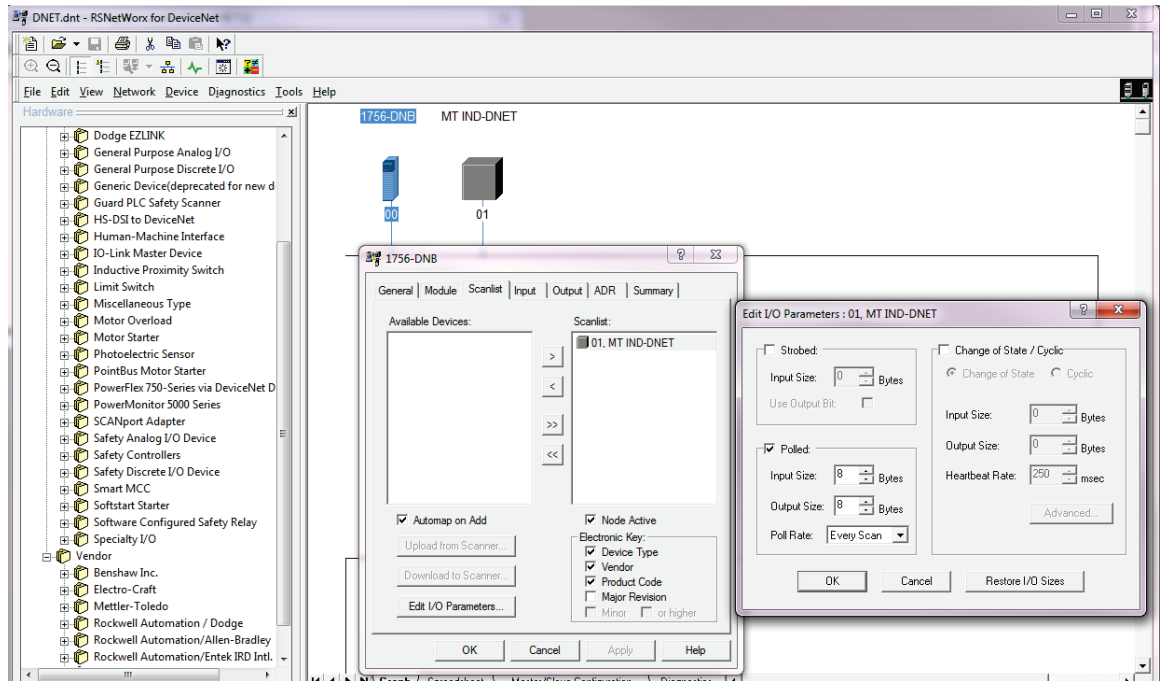

Figure 4-2: Connection Setup

Figure 4-3 shows the I/O mapping:

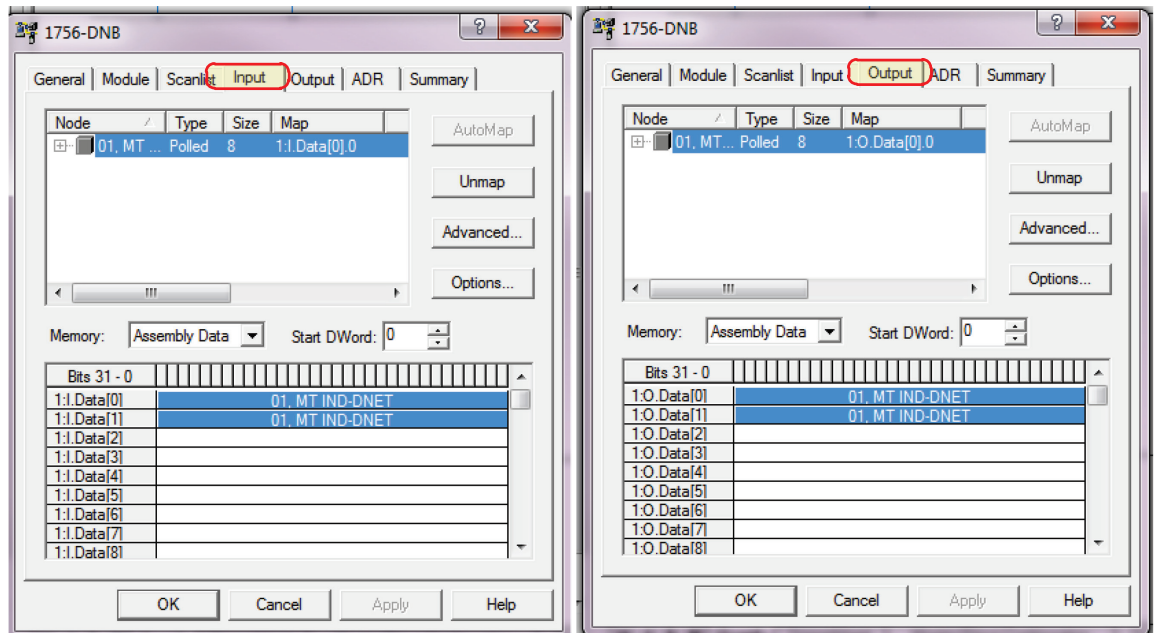

Figure 4-3: I/O Mapping

4.2. IND9D57 Setup

4.2.1. Communications

4.2.1.1. PLC configuration

4.2.1.1.1. DeviceNet

Node Address = 1

Data Rate = 250 KBaud

4.2.1.1.2. Data Format

Operating Mode = Compatibility Mode

Format = Floating Point

Byte Order = Word Swap

5 PROFIBUS

5.1. PLCs used for samples

Two PLCs are used for the PROFIBUS samples. An S7-315-2PN/DP, and an S7-1200C-AC/DC/RLY. There are a total of six (6) PROFIBUS samples for these two PLC, organized as follows

1. S7-315-2PN/DP
 - a. Classic Step 7, V5.5
 - i. Cyclic Data Access
 - ii. Shared Data Access via Cyclic Messaging.
 - b. TIA Portal V13
 - i. Cyclic Data Access
 - ii. Shared Data Access via Cyclic Messaging.
2. S7-1200C-AC/DC/RLY with a 1243-5 PROFIBUS Master module
 - a. TIA Portal V13
 - i. Cyclic Data Access
 - ii. Shared Data Access via Cyclic Messaging.

5.2. Notes on Shared Data Access with PROFIBUS

The IND9D57 implements PROFIBUS DP-V0, which means that Acyclic messages are not supported. To access Shared Data, a region of the allocated I/O space for the unit is used to request Read or Write Access, and to receive the results (see the shaded areas in the diagram below).

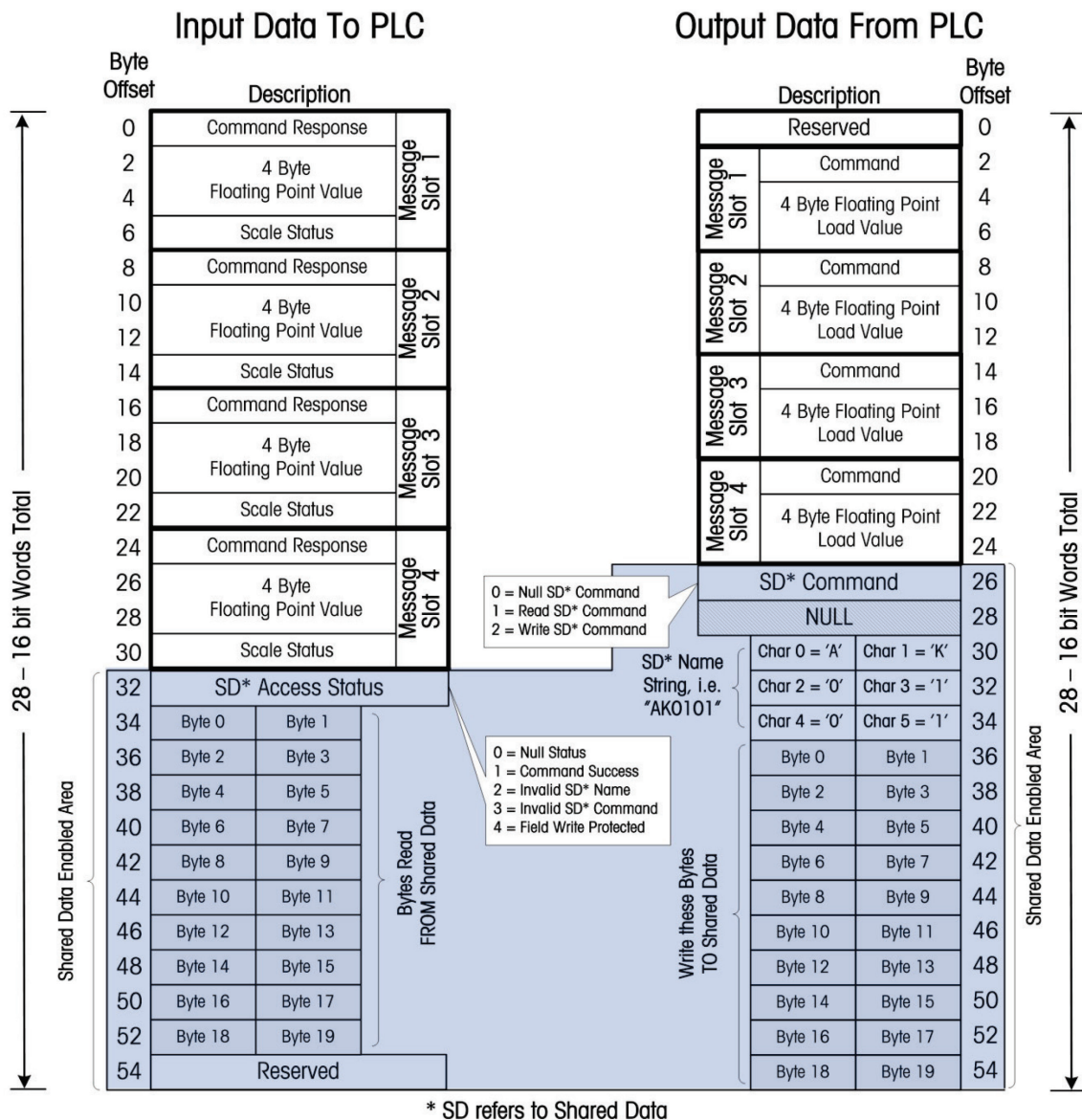

Figure 5-1: Floating Point Mode with Shared Data Access

This shaded area shown in Figure 5-1 always appears after the regions allocated for the Scale I/O. As a result, the **Shared Data Access** version of the programs will always use the "I/O 28 Wrd" selection from the Hardware Catalog of the Programming Tool, regardless of how many Message Slots have been defined for the unit.

The **Cyclic Data Access** versions of the program do not need to access Shared Data. So, they use the "I/O 4 Wrd" selection from the Hardware Catalog, which is the I/O definition required to interface with an IND9D57 set up for a Single Message Slot using Floating Point communications.

For these reasons, the PLC communication configurations between the Cyclic Data Access and the Shared Data Access versions of the program will be different.

5.3. IND9D57 Cyclic Data Access Setup in the PLC

The following figures show the setup for Cyclical Data Access in the PLC.

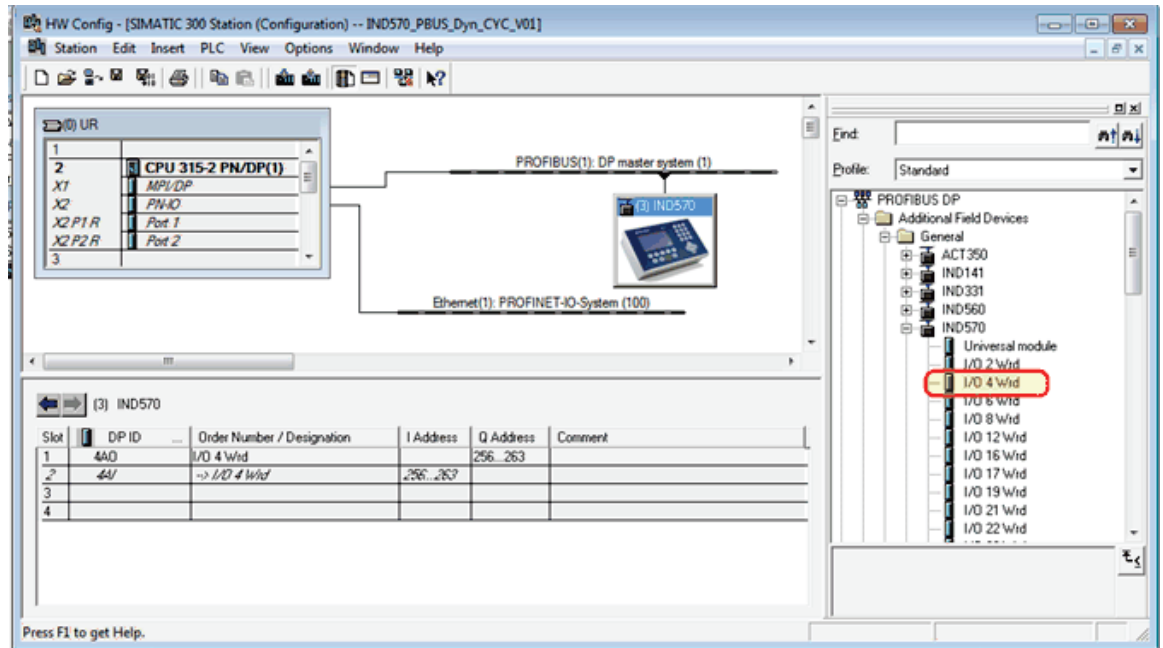

Figure 5-2: S7-315 Step 7, V5.5

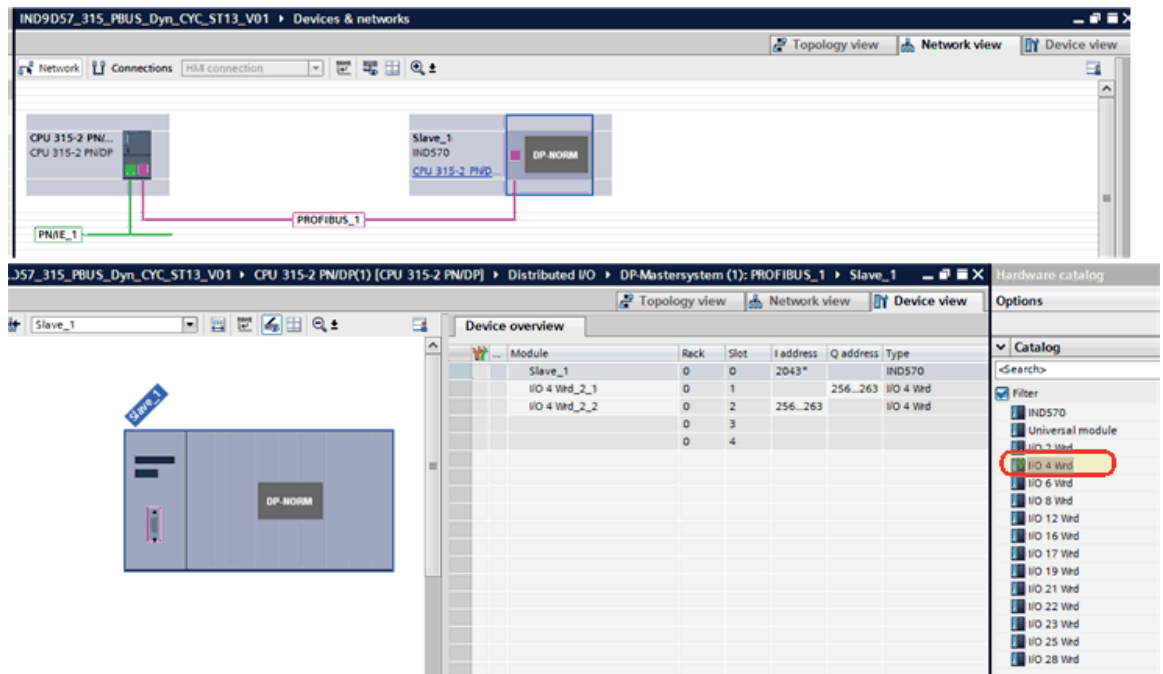

Figure 5-3: S7-315, TIA Portal, V13

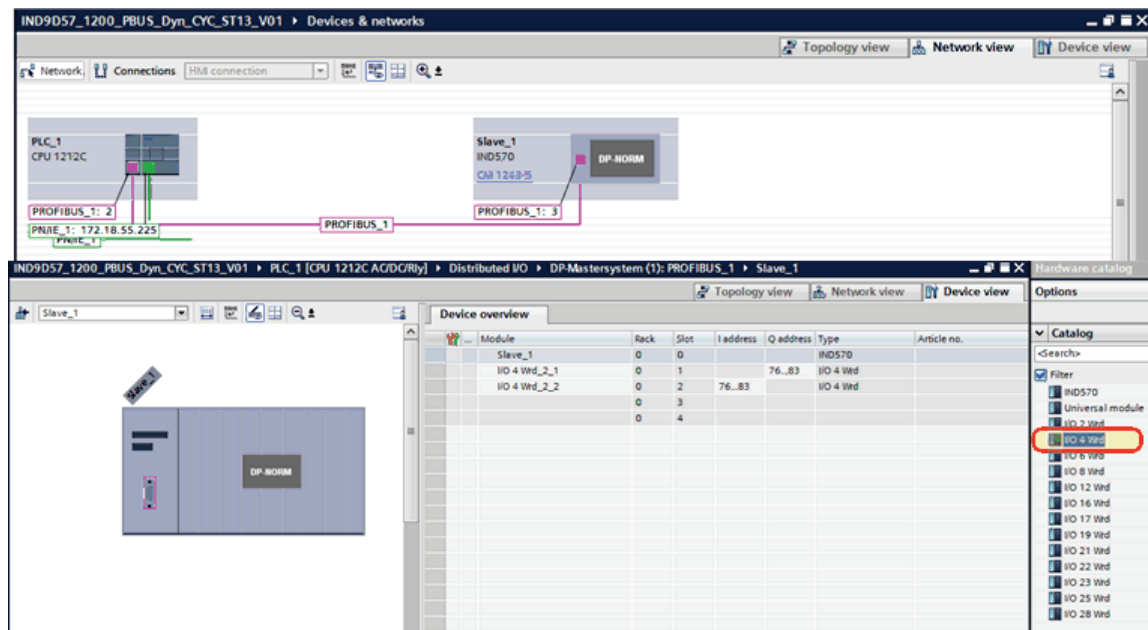

Figure 5-4: S7-1200, TIA Portal, V13

5.3.1. IND9D57 Setup Menu

5.3.1.1. Communications

5.3.1.1.1. PLC

PROFIBUS

Node = 3

Shared Data = Disabled

Data Format

Operating Mode = Compatibility Mode

Format = Floating Point

Byte Order = Byte Swap

Message Slots = 1

5.4. IND9D57 Shared Data Access Setup in the PLC

The following figures show the setup for Shared Data Access in the PLC.

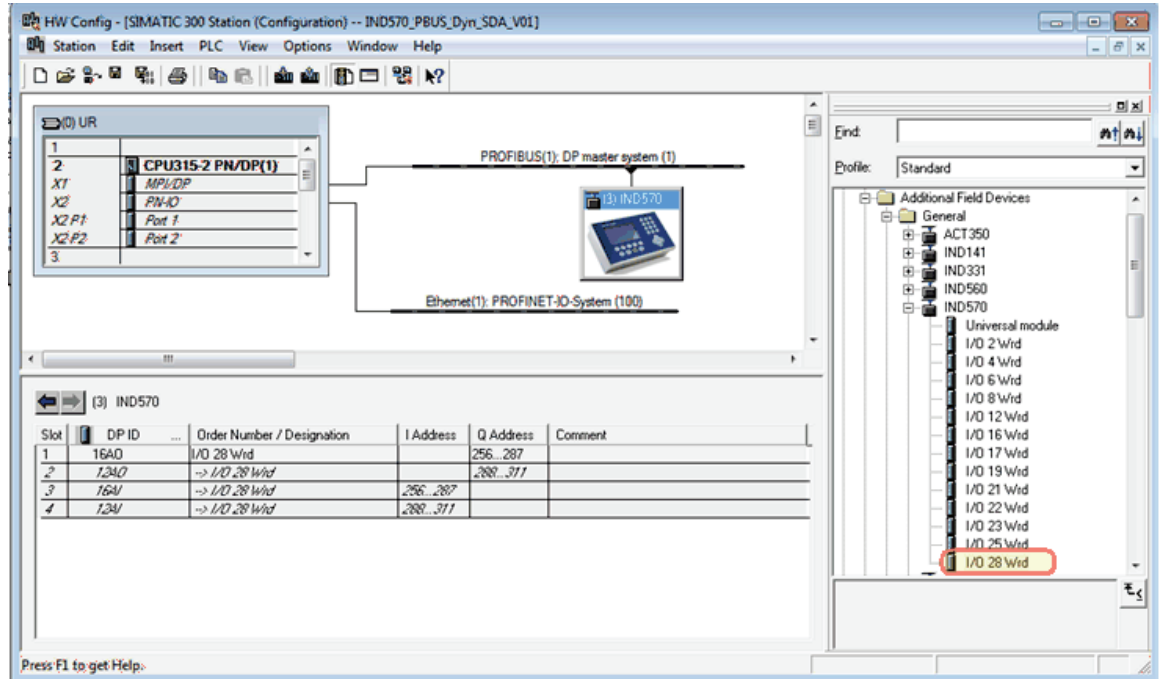

Figure 5-5: S7-315 Step 7, V5.5

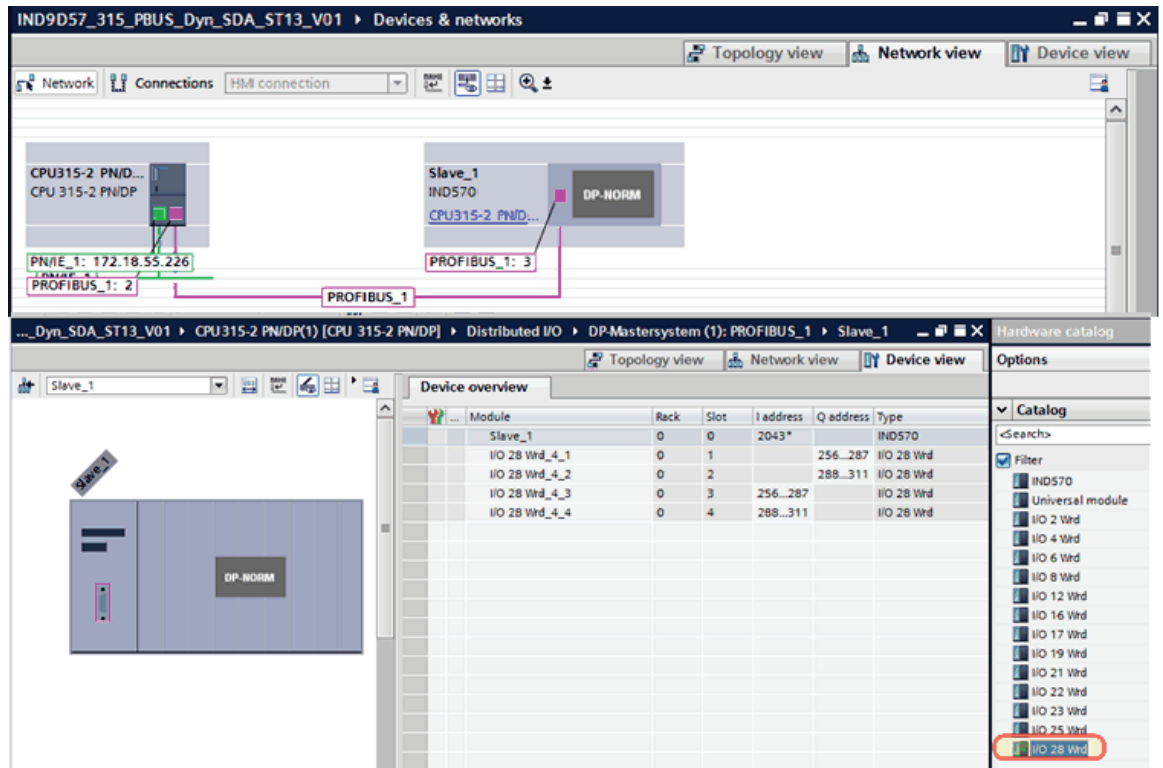

Figure 5-6: S7-315, TIA Portal, V13

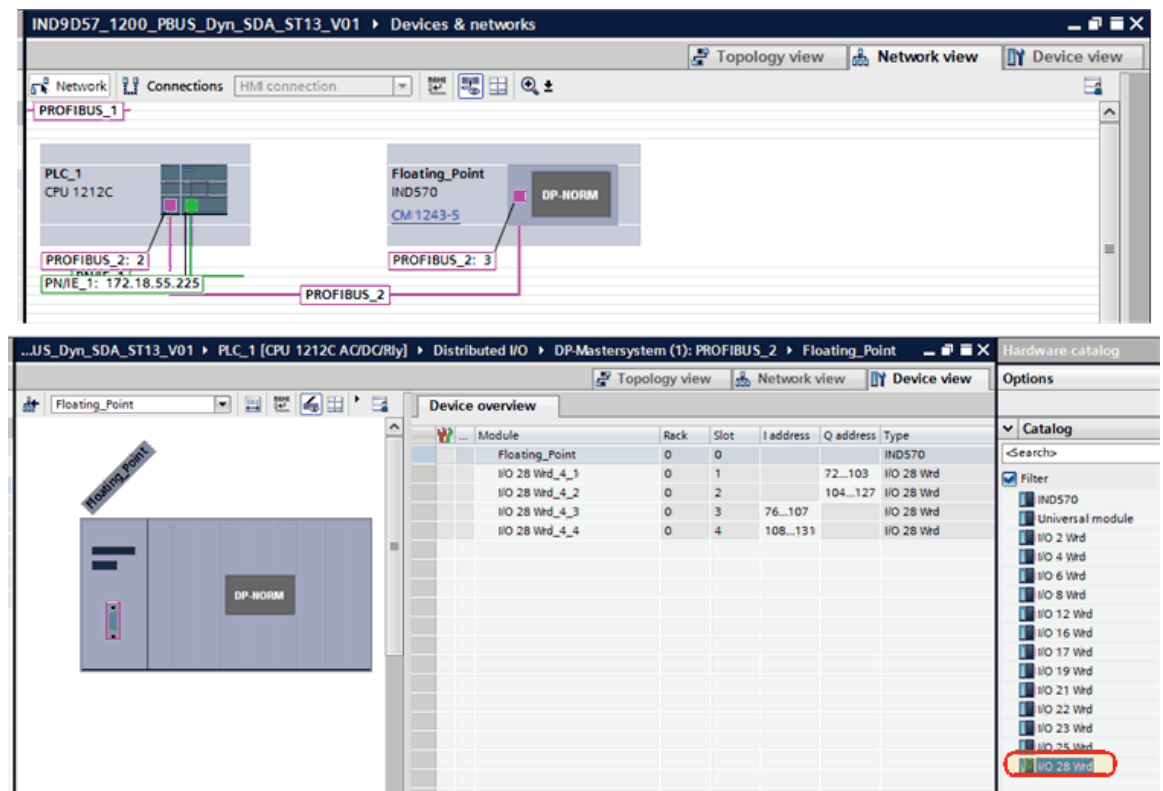

Figure 5-7: S7-1200, TIA Portal, V13

5.4.1. IND9D57 Setup Menu

5.4.1.1. Communications

5.4.1.1.1. PLC

PROFIBUS

Node = 3

Shared Data = Enabled

Data Format

Operating Mode = Compatibility Mode

Format = Floating Point

Byte Order = Byte Swap

Message Slots = 1

6 PROFINET

6.1. PLCs used for samples

Two PLCs are used for the PROFINET samples. An S7-315-2PN/DP, and an S7-1200C-AC/DC/RLY. There are a total of six (6) PROFINET samples for these two PLC, organized as follows

1. S7-315-2PN/DP
 - a. Classic Step 7, V5.5
 - i. Cyclic Data Access
 - ii. Shared Data Access via Acyclic Messaging.
 - b. TIA Portal V13
 - i. Cyclic Data Access
 - ii. Shared Data Access via Acyclic Messaging.
2. S7-1200C-AC/DC/RLY with a 1243-5 PROFIBUS Master module
 - a. TIA Portal V13
 - i. Cyclic Data Access
 - ii. Shared Data Access via Acyclic Messaging.

6.2. Notes on Shared Data Access with PROFINET

We will provide a brief description for how Shared Data Access is accomplished in this section. For details about how the IND9D57 accesses Shared Data over PROFINET, please review the IND570 PLC Manual's (30205335_R03_IND570_PLC_EN.pdf) Shared Data Access starting at section 7.10.3.

Shared Data is accessed using what Mettler Toledo terms the "Indirect Access" method. The message functions always use the same Message Index numbers (1, 2, and 3) for Shared Data Accesses. The desired Shared Data Value is specified in the first four words of the message itself by putting in the Class, Instance, Attribute, and length of the desired variable (found in the IND570's Shared Data Reference Manual, 30205337_R01_IND570_SDREF_EN.pdf).

6.2.1. Shared Data Writes

Data is written to the IND9D57 using a WRREC function (SFB53) with **Index = 1**. The data to be written should immediately follow the header data that specifies what shared data variable it is to be written to.



Figure 6-1: Shared Data Write

6.2.2. Shared Data Reads

Data is read from the IND9D57 with a two-step process.

1. Use a WRREC (SFB53) function with **Index = 2** to send the Class, Instance, Attribute, and Length of the variable requested to be read.
2. Use a RRECC (SFB52) with **Index = 3** to read the data from the requested Shared Data Variable. The PLC program should compare the returned Class, Instance, and Attribute with the requested variable to ensure that the data is from the correct source.

■ **Note:** If the PLC program needs to read the same Shared Data Variable repeatedly, with no other Shared Data accesses occurring in between, then after the initial read only Step 2 is needed because the IND9D57 remembers the last Shared Data variable that was accessed, and always returns the current data for that value until a new request comes in.

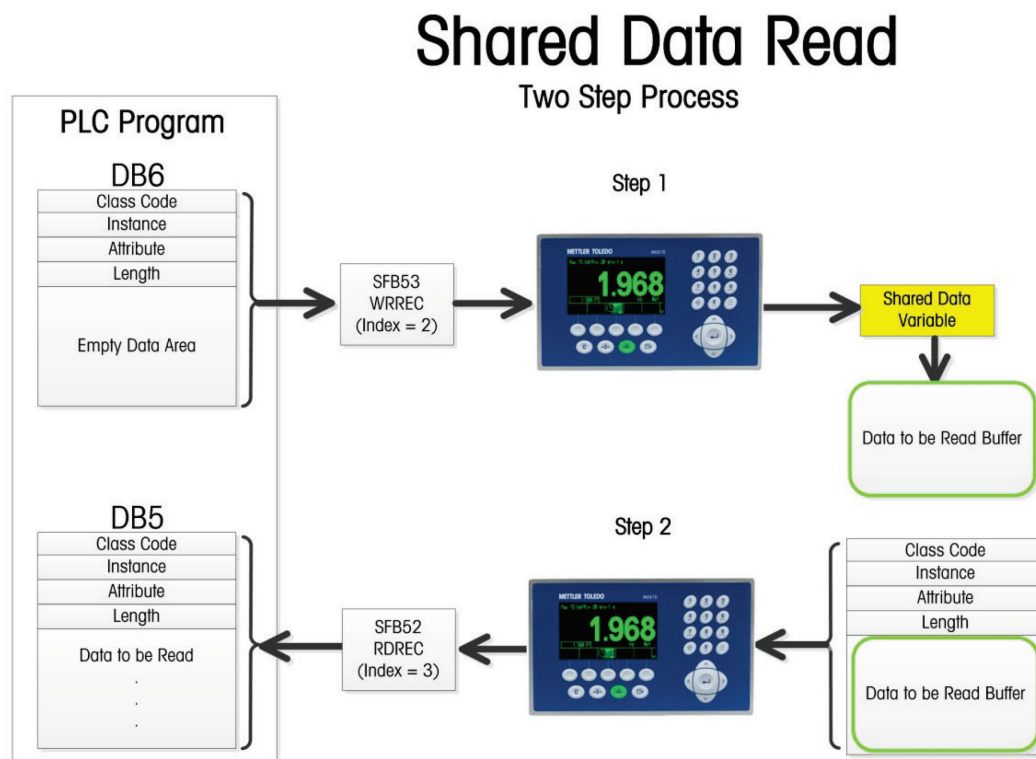

Figure 6-2: Shared Data Read

6.3. IND9D57 Setup in the PLC

The following figures show setup in the PLC. Note that the configuration will be the same in the PLC for either Cyclic Data Access or Shared Data Access.

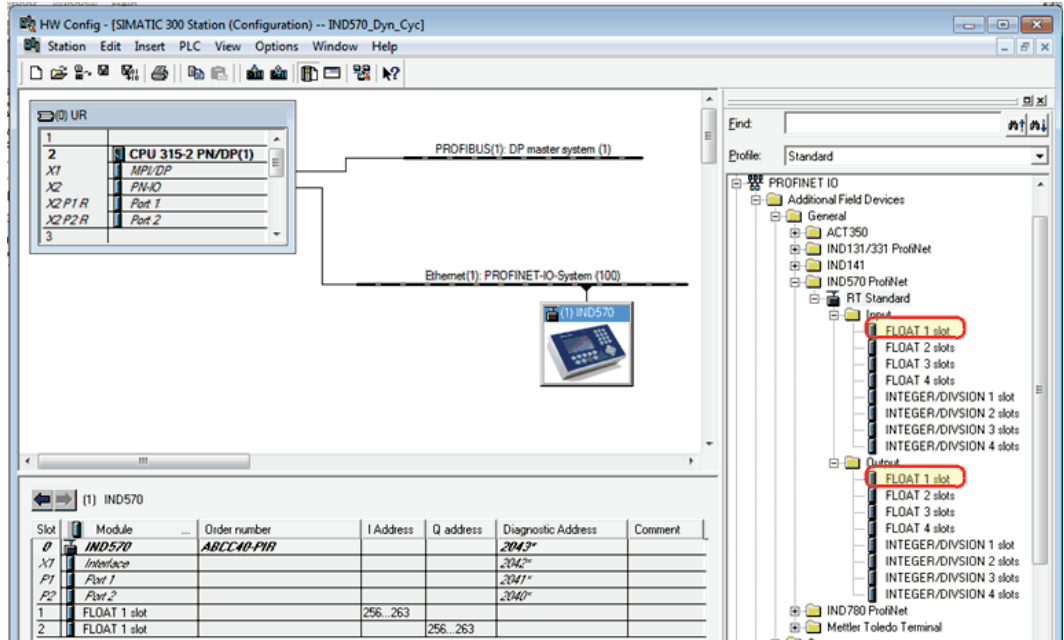

Figure 6-3: S7-315 Step 7, V5.5

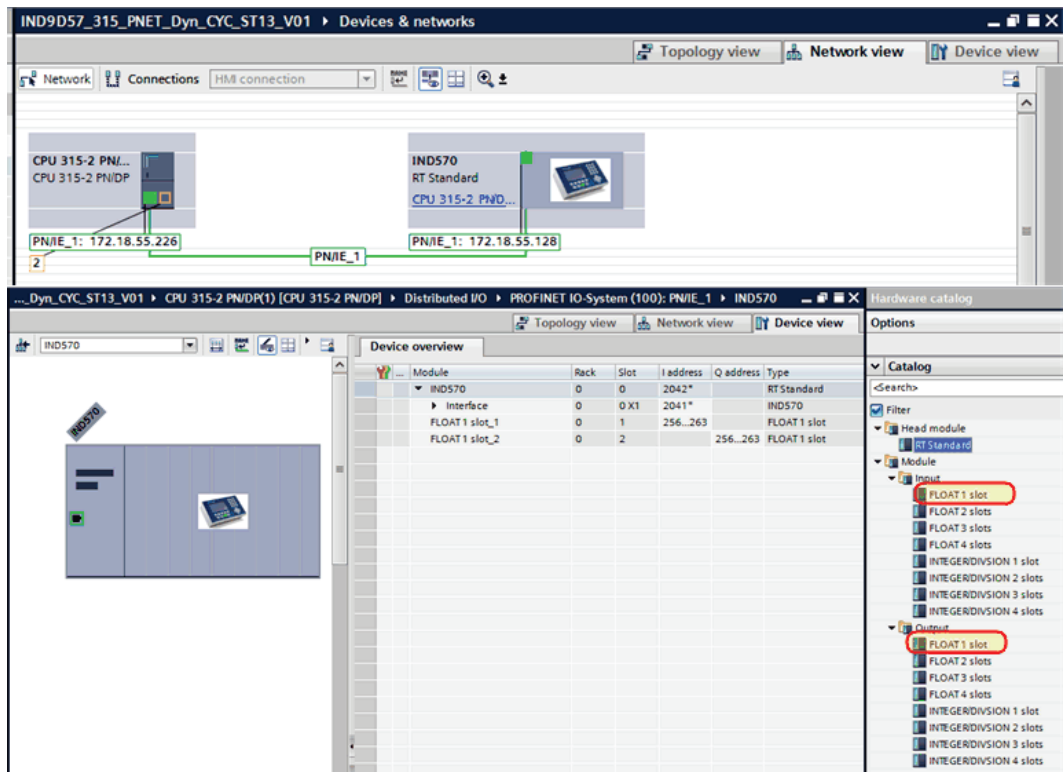

Figure 6-4: S7-315, TIA Portal, V13

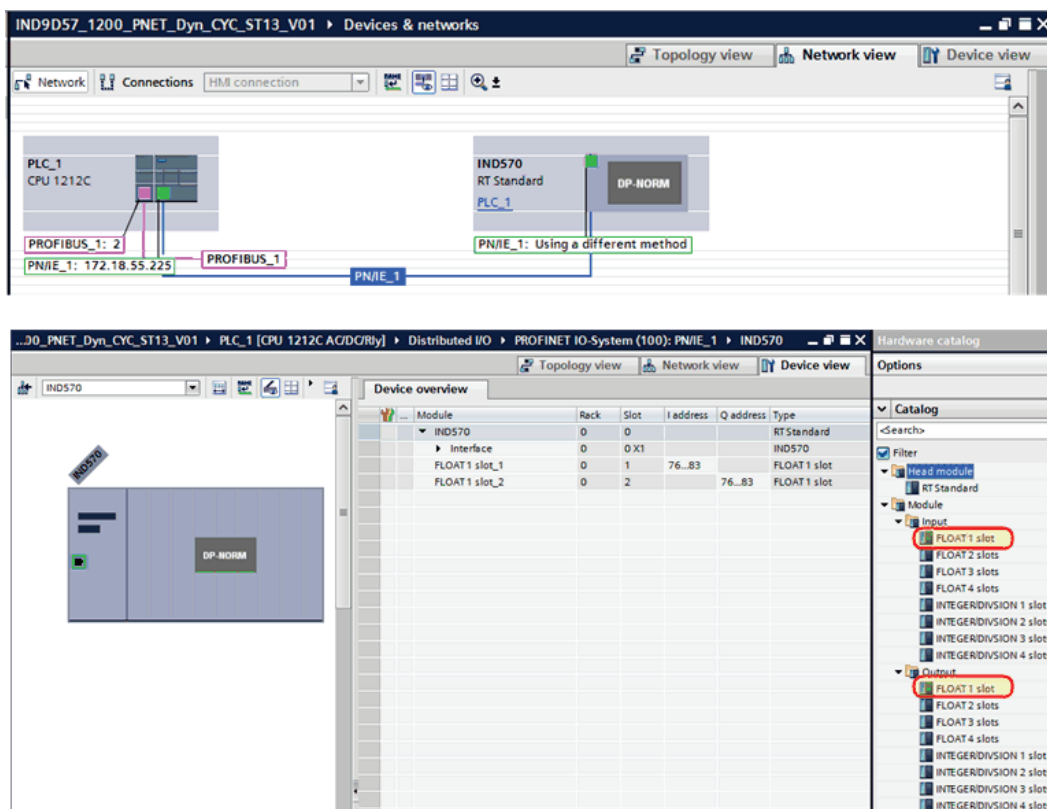

Figure 6-5: S7-1200, TIA Portal, V13

6.4. IND9D57 Setup Menu

6.4.1. Communications

6.4.1.1. PLC

PROFINET

IP Assignment = DCP

IP Address = 172.18.55.128*

Subnet Mask = 255.255.254.0*

Gateway Address = 172.18.54.1*

Device Name = ind570*

* Indicates Assigned by PLC's DCP system.

Data Format

Operating Mode = Compatibility Mode

Format = Floating Point

Byte Order = Byte Swap

Message Slots = 1

METTLER TOLEDO Service

To protect your product's future:

Congratulations on choosing the quality and precision of METTLER TOLEDO. Proper use according to these instructions and regular calibration and maintenance by our factory-trained service team ensure dependable and accurate operation, protecting your investment. Contact us about a service agreement tailored to your needs and budget.

We invite you to register your product at www.mt.com/productregistration so we can contact you about enhancements, updates and important notifications concerning your product.

www.mt.com/IND570

For more information

Mettler-Toledo, LLC
1900 Polaris Parkway
Columbus, OH 43240

© 2017 Mettler-Toledo, LLC
30415412 Rev. 00, 06/2017
Document version -



30415412