

Communication Module M 700[®] EC 700(X)

For Actuating Probe Controllers
(EC 400) - Automatic pH Measurement -



METTLER TOLEDO



71966

Warranty

Defects occurring within 1 year from delivery date shall be remedied free of charge at our plant (carriage and insurance paid by sender). Sensors, fittings, and accessories: 1 year.

©2007 Subject to change without notice

Return of products under warranty

Please contact our Service Team before returning a defective device. Ship the cleaned device to the address you have been given. If the device has been in contact with process fluids, it must be decontaminated/disinfected before shipment. In that case, please attach a corresponding certificate, for the health and safety of our service personnel.

Disposal

Please observe the applicable local or national regulations concerning the disposal of "waste electrical and electronic equipment".

Trademarks

The following registered trademarks are used in this instruction manual without further marking

SMARTMEDIA®

is a registered trademark of Toshiba Corp., Japan

FOUNDATION FIELDBUS™

is a trademark of Fieldbus Foundation, Austin, USA

Mettler-Toledo AG,
Process Analytics, Industrie Nord, CH-8902 Urdorf,
Tel. +41 (44) 729 62 11 Fax +41 (44) 729 26 36
Subject to technical changes.



EC Declaration of Conformity

EC 700

Mettler-Toledo GmbH

Process Analytics

Adresse Im Hackacker 15 (Industrie Nord), CH-8902 Urdorf, Schweiz
Briefadresse Postfach, CH-8902 Urdorf
Telefon 01-736 22 11
Telefax 01-736 26 36
Internet www.mt.com
Bank Credit Suisse First Boston, Zürich (Acc. 0635-370501-21-90)

Declaration of conformity Konformitätserklärung Déclaration de conformité



We/ Wir/Nous

Mettler-Toledo GmbH, Process Analytics
Im Hackacker 15
8902 Urdorf
Switzerland

declare under our sole responsibility that the product,
erklären in alleiniger Verantwortung, dass dieses Produkt,
déclarons sous notre seule responsabilité que le produit,

Description

Beschreibung/Description

EasyClean EC700

to which this declaration relates is in conformity with the following
standard(s) or other normative document(s),
auf welches sich diese Erklärung bezieht, mit der/den folgenden Norm(en)
oder Richtlinie(n) übereinstimmt,
auquel se réfère cette déclaration est conforme à la (aux) norme(s) ou
au(x) document(s) normative(s).

EMC Directive/

EMV-Richtlinie/

Directive concernant la CEM

89/336/EWG

Low-voltage directive/

Niederspannungs-Richtlinie/

Directive basse tension

73/23/EG

Place and Date of issue/

Ausstellungsort/ - Datum

Lieu et date d'émission

Urdorf, July 6th, 2005

Mettler-Toledo GmbH, Process Analytics

Waldemar Rauch
General Manager PO Urdorf

Thomas Hösli
Head of Operations and R&D

Norm/ Standard/ Standard

**EN 61010-1 / VDE 0411 Teil 1
EN 61326 / VDE 0843 Teil 20**

METTLER TOLEDO

CE_EasyClean_EC700_int.doc

Sitz der Gesellschaft Mettler-Toledo GmbH, Im Langacher, CH-8606 Grellensee

EC Declaration of Conformity

EC 700X

		Mettler-Toledo GmbH Process Analytics
		Adresse Im Hackacker 15 (Industrie Nord), CH-8902 Urdorf, Schweiz Briefadresse Postfach, CH-8902 Urdorf Telefon 01-736 22 11 Telefax 01-736 26 36 Internet www.mt.com Bank Credit Suisse First Boston, Zürich (Acc. 0835-370501-21-90)
Declaration of conformity Konformitätserklärung Déclaration de conformité		 0344
We/ Wir/Nous	Mettler-Toledo GmbH, Process Analytics Im Hackacker 15 8902 Urdorf Switzerland	
Description Beschreibung/Description	EasyClean EC700X I declare under our sole responsibility that the product, erklären in alleiniger Verantwortung, dass dieses Produkt, déclarons sous notre seule responsabilité que le produit,	
Explosion protection/ Explosionsschutzrichtlinie/ Prot. contre les explosions EMC	94/9/EG KEMA 04 ATEX 1134 NL-6612 AR Arnhem, KEMA 0344	
EMC Directive/ EMV-Richtlinie/ Directive concernant la CEM	89/336/EWG	
Low-voltage directive/ Niederspannungs-Richtlinie/ Directive basse tension	73/23/EG	
Place and Date of issue/ Ausstellungsort/ - Datum Lieu et date d'émission	Urdorf, July 6th, 2005	
Mettler-Toledo GmbH, Process Analytics		
		
Waldemar Rauch General Manager PO Urdorf	Thomas Hösli Head of Operations and R&D	
Norm/ Standard/ Standard	EN 61010-1 / VDE 0411 Teil 1 EN 61326 / VDE 0843 Teil 20 EN 50014 EN 50020 EN 50281-1-1 EN 50284	
		
CE_EasyClean_EC700X_int.doc		
Sitz der Gesellschaft Mettler-Toledo GmbH, Im Langacher, CH-8606 Grellensee		

Contents

EC 700 Module

Warranty	2
Disposal	2
Trademarks	2
EC Declaration of Conformity	3
Intended Use	9
Conformity with FDA 21 CFR Part 11	9
Safety Information	10
Application in Hazardous Locations: EC 700X Module	10
Software Version	11
Modular Concept	12
Short Description.....	13
Short Description: FRONT Module.....	13
Short Description: Menu Structure.....	14
Short Description: BASE Module.....	16
Overview of the System Components	17
Overview of the System Components	18
EC 700 Module	19
Terminal Plate EC 700(X) Module	20
Attaching the Terminal Plates.....	20
Inserting the Module.....	21
Wiring Example 1.....	22
Wiring Example VP and SMEK	23
Connecting the EasyClean 400(X)	24
Menu Selection.....	25
Menu Structure.....	25
Passcode Entry.....	26
Changing a passcode / Passcode lost	26
Configuring the Measurement Display	27
Start-Up.....	29
Parameter Setting: Operating Levels.....	30
Administrator level.....	30
Operator level.....	30
Viewing level	30
Parameter Setting: Lock Functions	31
Call up parameter setting	32

Contents

EC 700 Module

Settings of Sensor Data	33
Sensoface	35
SW 700-005: Tolerance Adjustment	38
Activating the Cal Tolerance Band.....	39
Logbook	46
Factory setting	46
Configure current output.....	47
Current Outputs: Characteristics	48
Output Filter	50
NAMUR Signals: Current Outputs	51
NAMUR Signals: Relay Contacts.....	52
Relay Contacts: Protective Wiring	53
Relay Contacts.....	54
Relay contacts, usage.....	54
Rinse Contact	55
Relay contacts, usage.....	55
Configuring the rinse contact	55
Icons in the measurement display:	56
Limit Value, Hysteresis, Contact Type	56
OK1, OK2 Inputs: Specify Level.....	57
Switching Parameter Sets via OK2	58
Selecting parameter set (A, B) via OK2 input	58
Signaling active parameter set via relay contact	58
Parameter Setting: Probe Control EasyClean 400(X).....	59
Cal preset values EC 400	60
Time control	60
Time control: Fixed interval.....	61
Time control: Week program	61
Parameter Setting: Program Flows	62
Cleaning, Continuous, Media monitoring off.....	62
Cal 2point, Continuous, Media monitoring off	63
Cal 1point, Continuous, Media monitoring off	64
Parking	66
Measurement, Short-time, Media monitoring off.....	67
Cal 2point, Short-time, Media monitoring off.....	68
Cal 1point, Short-time, Media monitoring off.....	69

Contents

EC 700 Module

Service	70
Configure program flow	71
Enter program name.....	71
Edit program step	71
Configure function	72
Activate monitoring	72
Parameter Setting: Installation	73
Select measurement procedure	74
External control via DCS	74
Control via Process Control System (DCS).....	75
Sensor Detection	77
Probe.....	77
Sealing Water, Wear Counter	77
Configuring Media Monitoring	78
Media Adapter	79
Additional Media (2).....	79
Start-Up.....	79
Calibration / Adjustment.....	80
Calibration Methods.....	82
One-Point Calibration	82
Two-Point Calibration	82
Three-Point Calibration	82
Sensor Replacement - First Calibration	82
Temperature Compensation	83
Temperature Compensation During Calibration.....	83
Automatic Temperature Compensation.....	83
Manual Temperature Compensation	83
Automatic Calibration.....	84
Manual Electrode Calibration.....	86
Select a calibration method	88
Calimatic Automatic Buffer Recognition	90
Calibration with Manual Entry of Buffer Values.....	92
Product Calibration	94
Calibration by Entering Data from Premeasured Electrodes.....	96
ORP Calibration/Adjustment	98
ISFET Zero Adjustment	100

Contents

EC 700 Module

Maintenance of EC 700	102
Sensor monitor	102
Temp probe adjustment	102
Probe Maintenance via M 700(X)	103
Diagnostics Functions	108
Call up diagnostics.....	108
Point of meas description	108
Logbook	108
Device description.....	109
Diagnostics of EC 700	110
Module diagnostics.....	110
Calibration timer.....	111
Adaptive calibration timer.....	111
Tolerance adjustment.....	111
Cal record.....	112
Sensor network diagram.....	112
Diagnostics of EC 400(X)	113
EC 400 Status.....	113
EC 400 network diagram.....	113
Call up diagnostics.....	116
Message list	116
Messages	117
Error Messages of EC 400(X).....	126
Specifications	132
Appendix:	136
Minimum Spans for Current Outputs.....	136
Buffer Table Mettler-Toledo	137
Buffer Table Merck / Riedel	138
Buffer Table DIN 19267.....	139
Buffer Table NIST Standard (DIN 19266: 2000-01)	140
Buffer Table Techn. Buffers to NIST	141
SW 700-002: Buffer Sets to be Entered.....	142
Index	149
Menu Selection	159
Quick Access.....	160

Intended Use

The module is used for simultaneous pH, ORP, and temperature measurement with glass electrodes. It allows connection of the EC 400(X) probe controller for fully automated pH measurement, cleaning, and calibration. The EC 700X module is intended for operation in locations subject to explosion hazards which require equipment of Group II, device category 2(1), gas/dust.

Conformity with FDA 21 CFR Part 11

In their directive “Title 21 Code of Federal Regulations, 21 CFR Part 11, Electronic Records; Electronic Signatures” the US American health agency FDA (Food and Drug Administration) regulates the production and processing of electronic documents for pharmaceutical development and production. This results in requirements for measuring devices used for corresponding applications. The following features ensure that the M 700(X) modular process analysis system meets the demands of FDA 21 CFR Part 11:

Electronic Signature

Access to the device functions is regulated and limited by individually adjustable codes – “Passcodes”. This prevents unauthorized modification of device settings or manipulation of the measurement results. Appropriate use of these passcodes makes them suitable as electronic signature.

Audit Trail Log

Every change of device settings can be automatically recorded and documented in the Audit Trail Log on the SmartMedia card. The recording can be encrypted.

Safety Information

Application in Hazardous Locations

Caution!

Never try to open the module! If a repair should be required, return the module to our factory.

If the specifications in the instruction manual are not sufficient for assessing the safety of operation, please contact the manufacturer to make sure that your intended application is possible and safe.

Be sure to observe during installation:

- Switch off power supply before replacing or inserting a module.
- Protect the signal inputs of the modules against electrostatic discharge.
- Before commissioning it must be proved that the device may be connected with other equipment.
- Observe correct shielding: To avoid interferences, the cable shielding must be completely covered by the ESD shielding cap.

Application in Hazardous Locations:

EC 700X Module

When using the EC 700X module, the stipulations for electrical installations in hazardous areas (EN 60079-14) must be observed.

When installing the device outside the range of applicability of the 94/9/EC directive, the appropriate standards and regulations in the country of use must be observed. The module has been developed and manufactured in compliance with the applicable European guidelines and standards.

Compliance with the European Harmonized Standards for use in hazardous locations is confirmed by the EC-Type-Examination Certificate. Compliance with the European guidelines and standards is confirmed by the EC Declaration of Conformity.

There is no particular direct hazard caused by the operation of the device in the specified environment.

Software Version

EC 700(X) Module

Device Software M 700(X)

The EC 700(X) module is supported by software version 5.0 or higher.

Module Software EC 700(X)

Software version 2.0

Query Actual Device/Module Software

When the analyzer is in measuring mode:
Press **menu** key, open Diagnostics menu.

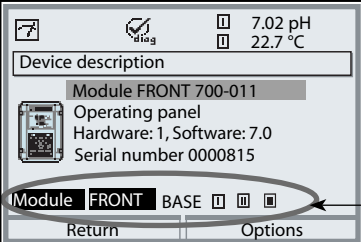
Menu	Display	Device description
		Provides information about all modules installed: Module type and function, serial number, hardware and software version and device options. Select the different modules (FRONT, BASE, slots 1 - 3) using the arrow keys.

Modular Concept

Basic Unit, Measuring Module, Additional Functions

The M 700(X) is an expandable modular process analysis system. The basic unit (FRONT and BASE modules) provides three slots which can be equipped by the user with any combination of measuring or communication modules. The software capabilities can be expanded by additional functions (options). Additional functions must be ordered separately. They are supplied with a device-specific TAN for function release.

M 700(X) Modular Process Analysis System

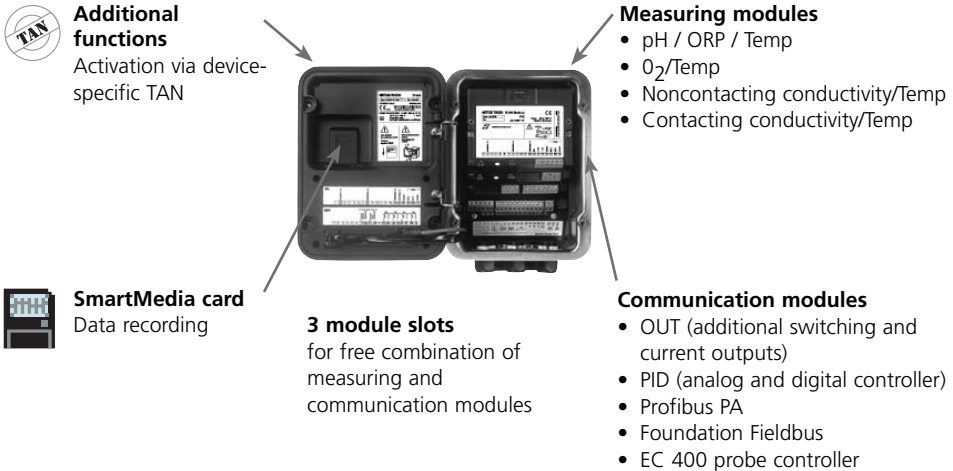

Documentation

The basic unit is accompanied by a CD-ROM containing the complete documentation.

Latest product information as well as instruction manuals for earlier software releases are available at www.mtpro.com.

Short Description

Short Description: FRONT Module

4 captive screws

for opening the analyzer

(Caution! Make sure that the gasket between FRONT and BASE is properly seated and clean!)

Transflective LC graphic display

(240 x 160 pixels)

white backlighting, high resolution and high contrast.

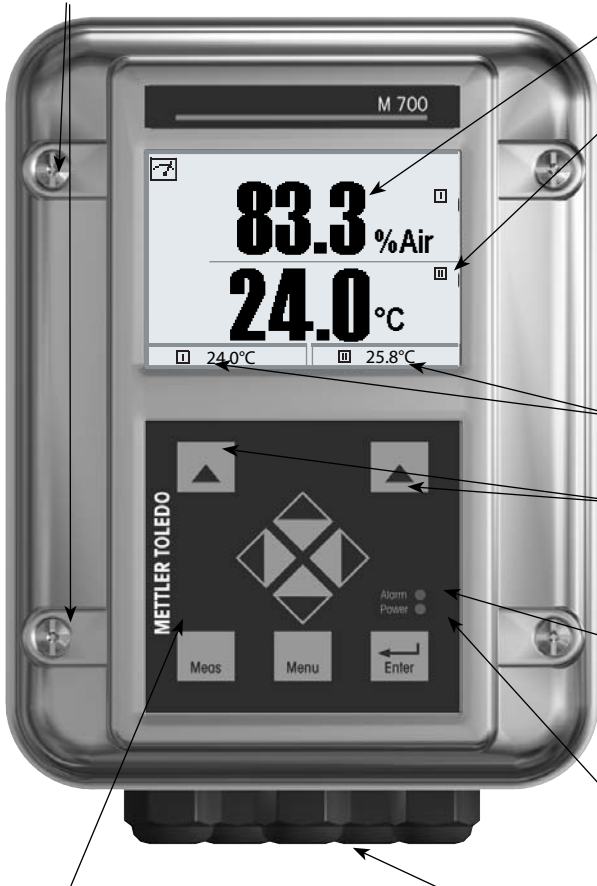

Measurement display

User interface

with plaintext menus as recommended by NAMUR.

Menu texts can be switched to: German, English, French, Italian, Swedish, and Spanish.

Intuitively acquirable menu logic, based on Windows standards.

Secondary displays

2 softkeys

with context-sensitive functions.

Red LED

signals failure (On) or maintenance request/function check (flashing) according to NE 44.

Green LED

Voltage supply okay

Control panel

3 function keys

(menu, meas, enter)

and 4 arrow keys for menu selection

and data entries

5 self-sealing cable glands

M20 x 1.5

for entry of voltage supply and signal lines

Short Description: Menu Structure

Basic Functions: Calibration, Maintenance, Parameter Setting, Diagnostics

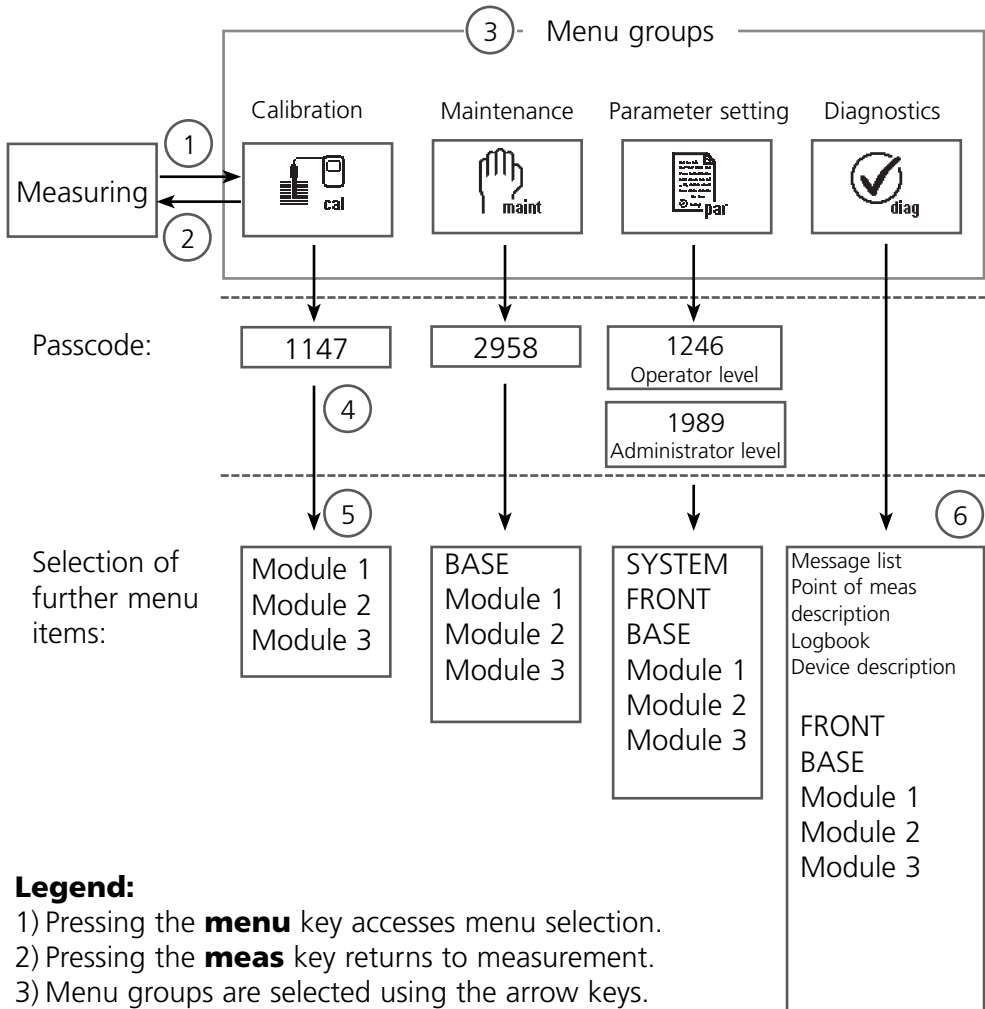

Legend:

- 1) Pressing the **menu** key accesses menu selection.
- 2) Pressing the **meas** key returns to measurement.
- 3) Menu groups are selected using the arrow keys.
- 4) Press **enter** to confirm, enter passcode.
- 5) Further menu items are displayed.
- 6) Selected functions of the Diagnostics menu can be recalled via softkey even when in measuring mode.

Short Description: FRONT Module

View into the open device (FRONT module)

Slot for SmartMedia card

- Data recording
The SmartMedia card expands the measurement recorder capacity to > 50000 records.
- Exchange of parameter sets
5 parameter sets can be stored on the SmartMedia card. The 2 internal parameter sets can be switched by remote control.
Configurations can be transmitted from one analyzer to the other.
- Function expansions
are possible with additional software modules, which are released using transaction numbers (TAN)
- Software updates

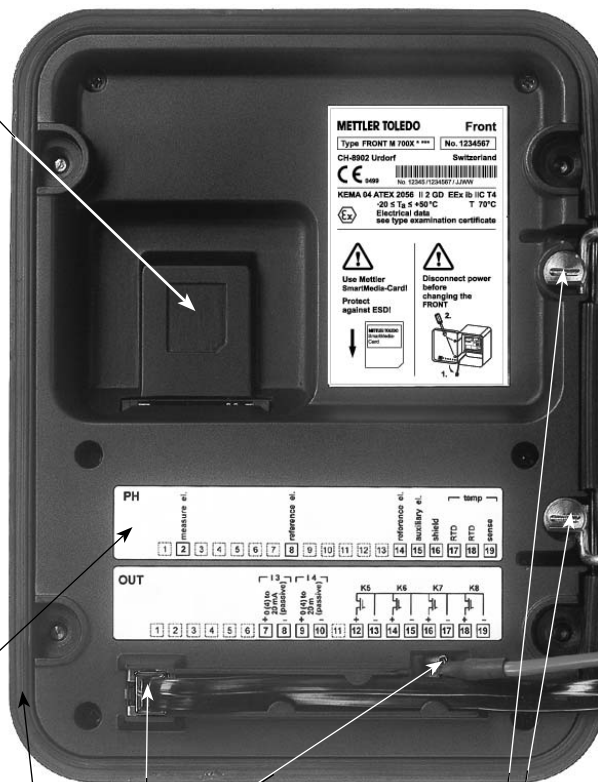

Terminal plates of "hidden" modules

Each module comes with an adhesive label containing the contact assignments. This label should be stuck to the inner side of the front (as shown). Then, the terminal assignments remain visible even if further modules are inserted.

Replacing the front module

Pull off power cord and ground wire. To separate the FRONT module from the BASE module, turn the retaining screws of the pivot hinge by 90°.

The circumferential sealing

guarantees IP 65 protection and allows spray cleaning / disinfection.

Caution! Keep clean!

Short Description: BASE Module

View into the open device (BASE module, 3 function modules installed)

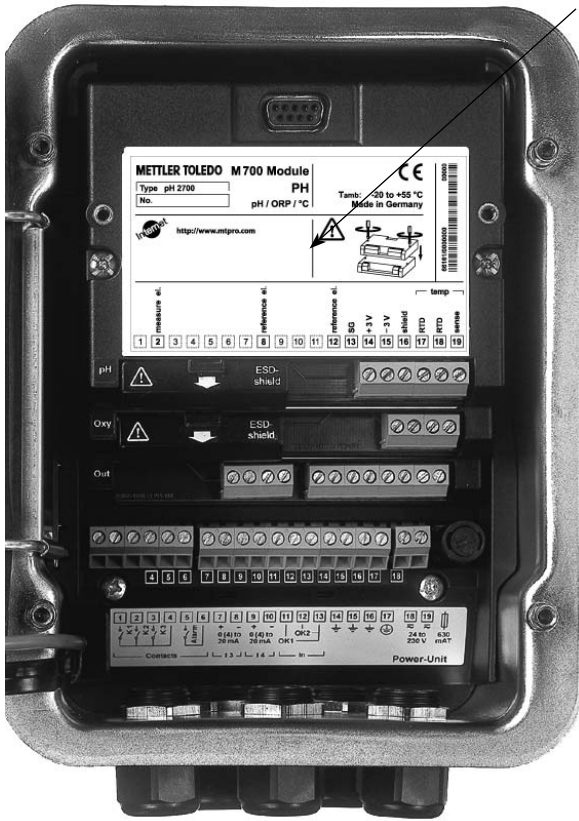

Module equipment

Module identification: Plug & Play.

Up to 3 modules can be combined as desired. Several input and communication modules are available.



Notice

Only one module can be connected in addition to a i700 module.

BASE module

2 current outputs (free assignment of process variable) and 4 relay contacts, 2 digital inputs.

VariPower broad-range power supply, 20 ... 265 V AC/DC, suitable for all public mains supplies in the world.

Power supply units, IS version:

100 ... 230 V AC or
24 V AC/DC



Warning!

Do not touch the terminal compartment, there may be dangerous contact voltages!

Important notice concerning SmartMedia card

The SmartMedia card may be inserted or replaced with the power supply switched on. Before a memory card is removed, it must be "closed" in the maintenance menu. When closing the device, make sure that the sealing is properly seated and clean.

Overview of the System Components

Fully Automated Process Analysis System

The fully automated process analysis system consists of the following components

- M 700(X) (modular process analysis system)
- EC 400(X) (automatic control of retractable probes)
- Retractable probe, e.g. InTrac 777, InTrac 798e

The system is operated from the M 700(X). Four operating modes are provided: calibration, parameter setting, maintenance, diagnostics.

The EC 700(X) module consists of 2 functional groups:

- EC 700(X) (measuring circuit)
- EC 400(X) (probe control)

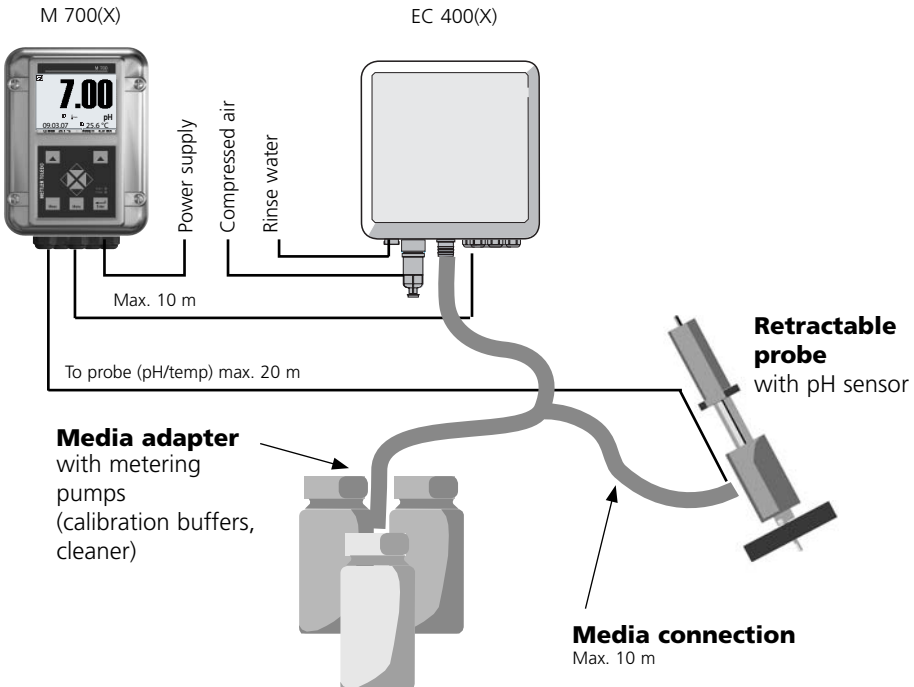

Overview of the System Components

M 700(X) Basic Unit and EC 700(X) Controller Module for Retractable Probes as well as EC 400(X) Probe Controller

M 700(X) basic unit. The EC 700(X) module is located in one of the 3 module slots available.

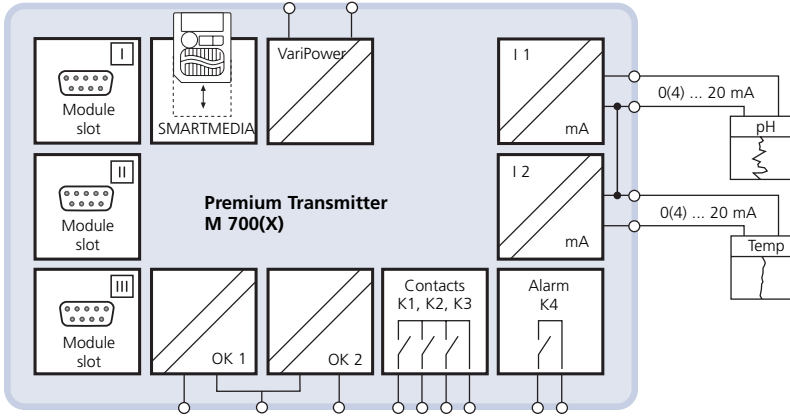

EC 700(X) Controller Module for Retractable Probes and EC 400(X) Probe Controller:

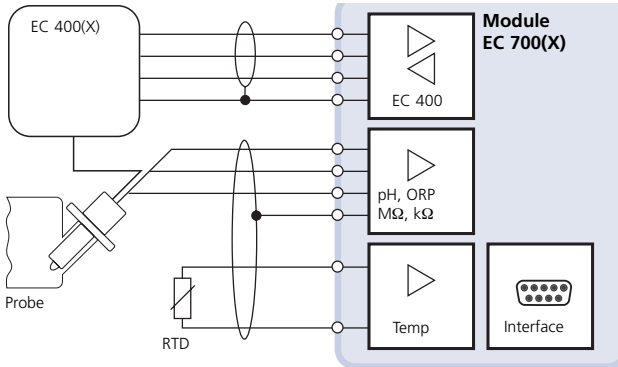

EC 700(X) Module

Measuring Circuit and Probe Control Function Blocks

For a direct access to the function descriptions related to the EC 400(X) probe controller, please refer to the overview on the back page of this manual.

You can document your specific settings for the EC 400(X) probe controller in the Excel spreadsheet from the CD-ROM (supplied with M 700(X) or as download from www.mt.com/pro)

Measuring Circuit and Probe Control Function Blocks

Probe Control

The EC 700(X) module allows connection of the EC 400(X) probe controller for fully automated pH measurement, cleaning, and calibration.

Measuring Circuit

Even without the EC 400(X), the EC 700(X) module is a fully fledged pH measuring module for simultaneous pH, ORP, and temperature measurement with glass electrodes.

This instruction manual describes the whole functionality of the EC 700(X) module corresponding to the following menu groups:

- Calibration
- Maintenance
- Parameter setting
- Diagnostics

The M 700(X) is an expandable modular device system.
For latest product information, please refer to:

www.mt.com/pro

Terminal Plate EC 700(X) Module

Terminal Plate EC 700 Module:

METTLER TOLEDO M 700 Module		CE	
Type EC 700 X	PH	Tamb: -20 to +55 °C	
No.	pH / EC 400	Made in Germany	
Internet http://www.mt.com			
pH sensor		EC 400	
meas. el.	ref. el.	SG	RTD
2	8	12	13
		14	15
		shield	
		A	B
		16	17
		GND	6.8 V
		18	19
		RS 485	supply

Terminal Plate EC 700X Module:

METTLER TOLEDO M 700X Module		CE	
Type EC 700 X	PH	0499	
No.	pH / EC 400	Tamb: -20 to +50 °C	
		Made in Germany/Kassel	
KEMA 04 ATEX 2056 Electr. data see type examination certificate II 2 (1) GD EEx ib [ia] IIC T4 T 70 °C CH-8902 Urdorf Switzerland		Entity, T _a = 50 °C	
IS, CLASS I, DIV1, GRP A, B, C, D, T4 CLASS I, ZONE 1, AEx ib [ia], GRP IIC, T4 control dwg. 201.004-110		with IS circuits extending into DIV 1	
NI, CII, DIV 2, GRP A, B, C, D AIS, CII, Zone 1, Ex ib [ia] IIC T4 NI, CII, Zone 2, Ex na [ia] IIC control dwg. 201.004-120			
pH sensor		EC 400 X	
measure electrode	reference electrode	SG	RTD
2	8	12	13
		14	15
		shield	
		A	B
		16	17
		GND	6.8 V
		18	19
		RS 485	supply

Attaching the Terminal Plates

The terminal plates of the lower modules can be stuck to the inner side of the door. This facilitates maintenance and service.



Inserting the Module

Note: Be sure to connect the shielding properly!



The terminals 2 and 8 are covered by an ESD shield. To connect the sensor cable, just pull it back.

Make sure that the cable glands are tightly closed to protect against humidity.

1. Switch off power supply
2. Open the device (loosen the 4 screws at the front)
3. Place module in slot (D-SUB connector)
4. Tighten fastening screws of the module
5. Open ESD shielding cap (covering terminals 2 and 8)
6. Connect sensor cable.
To avoid interferences, the cable shielding must be completely covered by the ESD shielding cap.
7. Close ESD shielding cap (covering terminals 2 and 8)
8. Connect RS 485 interface to probe controller (terminals 16 ... 19)
9. Close device, tighten screws at the front
10. Switch on power supply
11. Set parameters

Wiring Example 1

Wiring Example InPro 3200SG
pH/ORP measurement (pH/ORP/temp) with solution ground (SG)

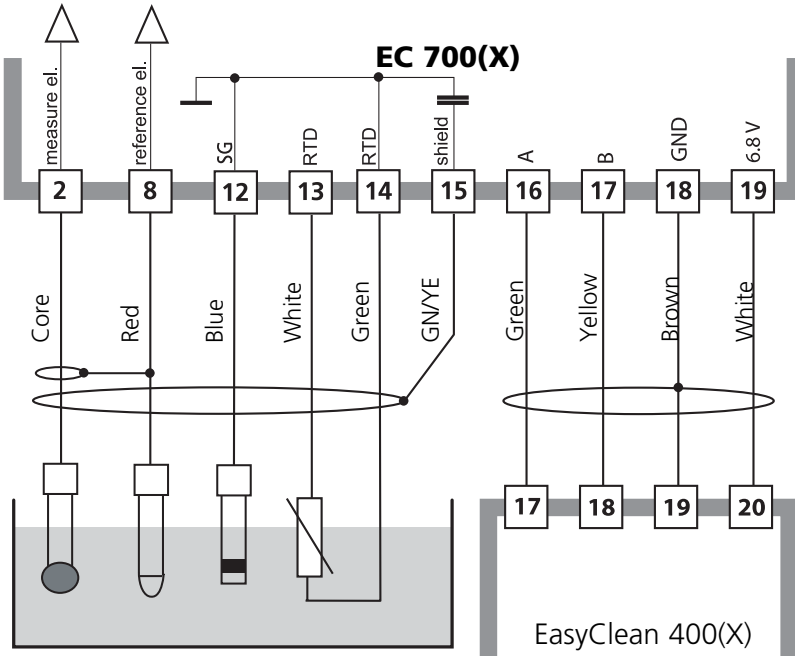

Wiring Example 2

Wiring Example

pH measurement (pH/temp) with monitoring of glass electrode

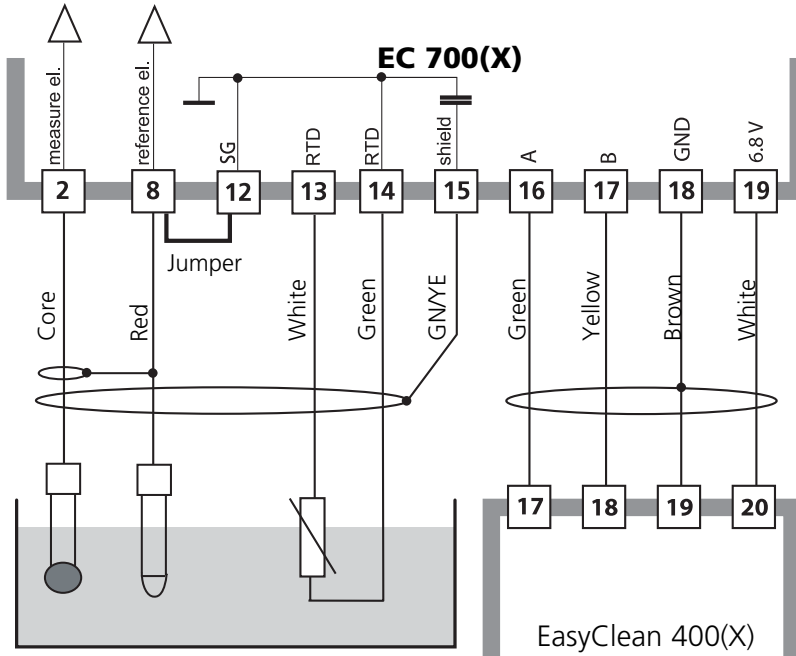

Connecting the EasyClean 400(X)

Probe Controller for Fully Automated Measurement, Cleaning, and Calibration

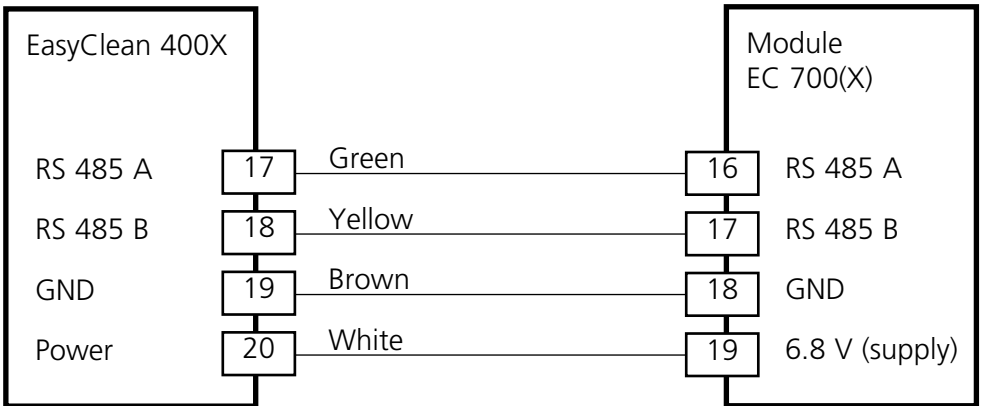

EasyClean 700(X) Controller

The EasyClean 700(X) probe controller comes with an installation manual, free download at www.mt.com/pro.

Menu Selection

After switching on, the analyzer performs an internal test routine and automatically detects the number and type of modules installed. Then, the analyzer goes to measuring mode.

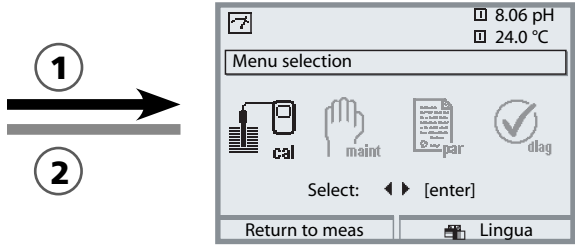

- 1 Pressing **menu** accesses menu selection.
- 2 Pressing **meas** returns to measurement.
- 3 Arrow keys for selecting a menu group
- 4 **enter** key for confirming a selection

Menu Structure

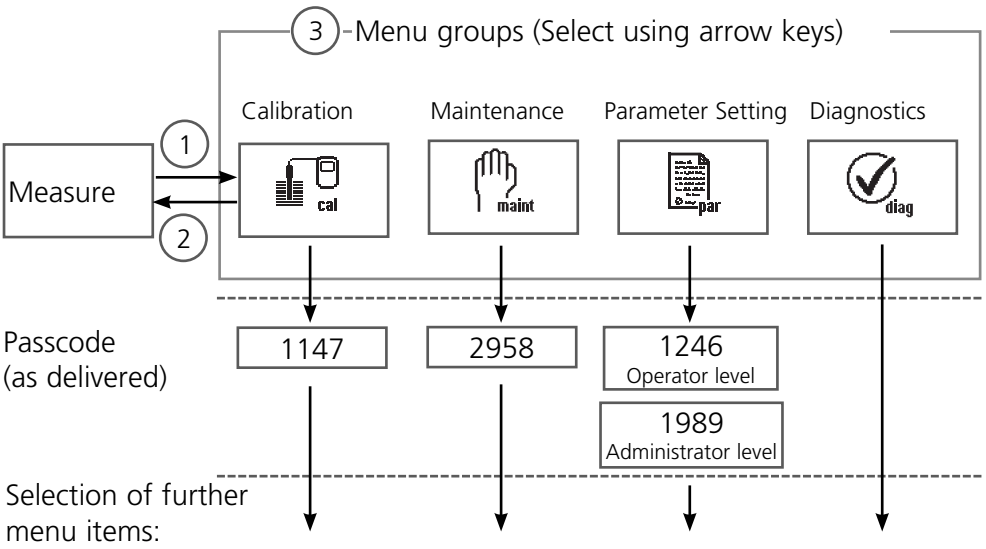

Passcode Entry

To enter a passcode

Select the position using the left/right keys, then edit the number using the up/down keys. When all numbers have been entered, confirm with **enter**.

To change a passcode

- Open the menu selection (**menu**)
- Select parameter setting
- Administrator level, enter passcode
- Select System control: Passcode entry

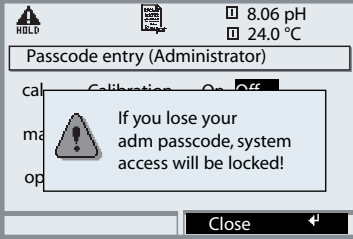
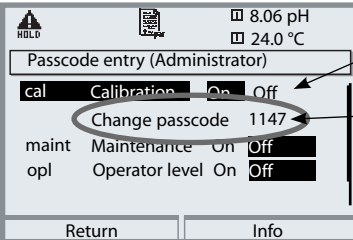
Menu	Display	System control: Passcode entry								
	 	<h3>Changing a passcode</h3> <h4>“Passcode entry” menu</h4> <p>When this menu is opened, the analyzer displays a warning (Fig.). Passcodes (factory settings):</p> <table border="0"> <tr> <td>Calibration</td> <td>1147</td> </tr> <tr> <td>Maintenance</td> <td>2958</td> </tr> <tr> <td>Operator level</td> <td>1246</td> </tr> <tr> <td>Administrator level</td> <td>1989</td> </tr> </table> <p>If you lose the passcode for the Administrator level, system access will be locked! Please consult our technical support!</p> <h4>To change a passcode</h4> <p>Select “On” using arrow keys, confirm with enter.</p> <p>Select the position using the left/right keys, then edit the number using the up/down keys.</p> <p>When all numbers have been entered, confirm with enter.</p>	Calibration	1147	Maintenance	2958	Operator level	1246	Administrator level	1989
Calibration	1147									
Maintenance	2958									
Operator level	1246									
Administrator level	1989									

Configuring the Measurement Display

Select menu: Parameter setting/Module FRONT/Measurement display

Pressing **meas** (1) returns the analyzer to the measuring mode from any function.

All process variables coming from the modules can be displayed. The table on the next page describes how to configure the measurement display.



Measurement display



Typical display for 2 pH measurement points.

Secondary displays

Additional values, also date and time, can be displayed depending on the modules installed.

Softkeys

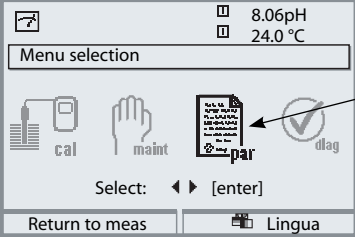
In measuring mode, the softkeys allow selection of values for the secondary displays or control of functions (user defined).

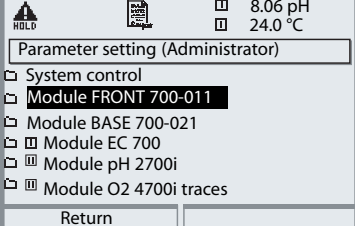
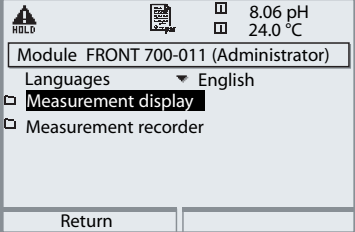
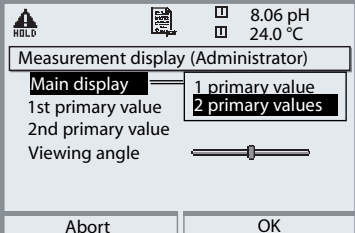
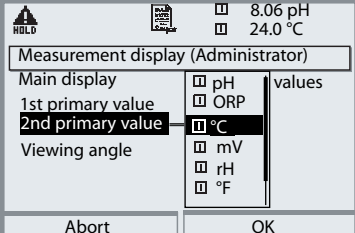
Menu	Display	Configure measurement display
		<p>Configure measurement display Press menu key to Menu selection Select parameter setting using arrow keys, confirm with enter. Select: “Administrator level”: Passcode 1989 (default setting).</p>
		<p>Parameter setting: Select “Module FRONT”</p>
		<p>Front module: Select “Measurement display”</p>
		<p>Measurement display: Set the number of primary values (large display) to be displayed</p>
		<p>Select process variable(s) to be displayed and confirm with enter. Pressing the meas key returns to measurement.</p>

Start-Up

Prerequisite

Mechanical and electrical installation of the components has been performed according to the separately enclosed operating and installation instructions (free download at **www.mt.com/pro**):

- M 700(X)
- EC 400(X) or Uniclean 900(X)
- Retractable probe



Warning!

Before working on the retractable probe, it must be moved into SERVICE position. Be sure to read and observe the respective instruction manual!

Caution!

Be sure to execute the following steps in the specified order!

- 1) Insert the EC 700 module (see Page 20)
- 2) Connect sensor cable and probe controller (see Pages 21...23)
- 3) Configure the EC 700 module (Page 33)

Parameter Setting: Operating Levels

Viewing level, Operator level, Administrator level

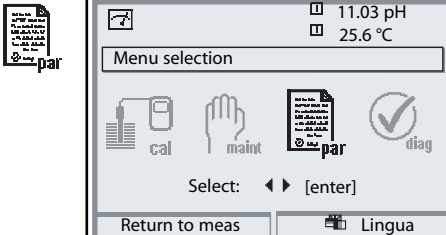

Note: HOLD mode (Setting: BASE module)

Menu	Display	Viewing level, Operator level, Administrator level
	<p>11.03 pH 25.6 °C</p> <p>Menu selection</p> <p>cal maint par diag</p> <p>Select: < [enter]</p> <p>Return to meas Lingua</p>	<p>Call up parameter setting</p> <p>From the measuring mode: Press menu key to select menu. Select parameter setting using arrow keys, confirm with enter.</p>
	<p>11.03 pH 25.6 °C</p> <p>Parameter setting</p> <p>Viewing level (All Data) view Operator level (Operation Data) opl Administrator level (All Data) adm</p> <p>Return</p>	<p>Administrator level</p> <p>Access to all functions, also passcode setting. Releasing or blocking a function for access from the Operator level.</p>
	<p>HOLD 11.03 pH 25.6 °C</p> <p>Module FRONT (Administrator)</p> <p>Languages English Measurement display Measurement recorder KI recorder</p> <p>Return Release</p>	<p>Functions which can be blocked for the Operator level are marked with the "lock" symbol. The functions are released or blocked using the softkey.</p>
	<p>HOLD 11.03 pH 25.6 °C</p> <p>Module FRONT</p> <p>Languages English Measurement display Measurement recorder KI recorder</p> <p>Return</p>	<p>Operator level</p> <p>Access to all functions which have been released at the Administrator level. Blocked functions are displayed in gray and cannot be edited (Fig.).</p> <p>Viewing level</p> <p>Display of all settings. No editing possible!</p>

Parameter Setting: Lock Functions

Administrator level: Enable / lock functions for Operator level

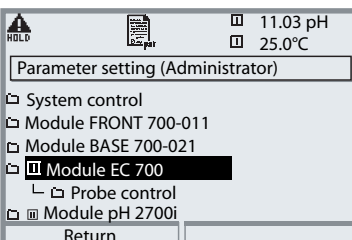
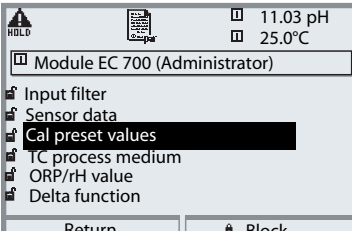
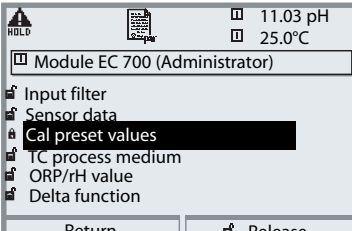
Note: HOLD mode (Setting: BASE module)

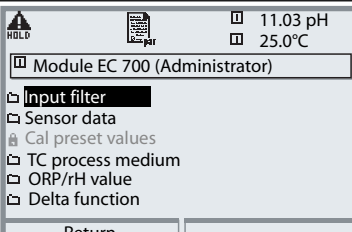
Menu	Display	Administrator level: Enable / lock functions
		<p>Example: Blocking access to the calibration adjustments from the Operator level</p> <p>Call up parameter setting Select Administrator level. Enter passcode (1989). Select a pH module using arrow keys, confirm with enter.</p>
		<p>Select "Cal preset values" using arrow keys, "Block" with softkey.</p>
		<p>Now, the "Cal preset values" line is marked with the "lock" icon. This function cannot be accessed from the Operator level any more. The softkey function changes to "Release".</p>
		<p>Call up parameter setting Select <u>Operator level</u>, passcode (1246). Select a pH module. Now, the locked function is displayed in gray and marked with the "lock" icon.</p>

Activating Parameter Setting

Call up parameter setting

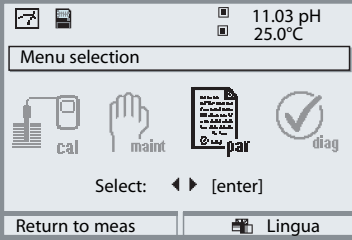
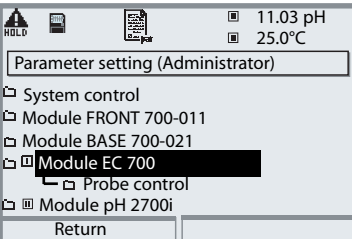
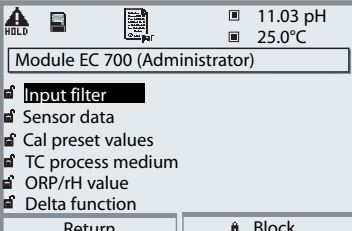
Menu	Display	Parameter setting
		<p>Call up parameter setting</p> <p>From the measuring mode: Press menu key to select menu. Select parameter setting using arrow keys, confirm with enter. Passcode as delivered: 1989</p>
		<p>Select "Module EC 700", confirm with enter.</p>
		<p>Select parameter using arrow keys, confirm with enter.</p>

During parameter setting the analyzer is in HOLD mode:

Current outputs and relay contacts behave as configured (BASE module).

Settings of Sensor Data

With "Auto", the tolerance limits for the monitoring criteria are determined by the analyzer. They are displayed in gray. These values cannot be edited. With "Individual", the tolerances can be adjusted.

Note: HOLD mode active.

Parameter	Default	Selection / Range / Notes
Input filter • Pulse suppression	Off	Off, On (suppression of fast transients at the input)
Sensor data		
• Sensor type	Standard	Standard, ISFET (ISFET: Insert pH 2700 module)
• Temperature detection		
- Temperature probe	Pt 1000	Pt100, Pt1000, NTC 8.55 k Ω , NTC30k Ω (sensor)
- Measuring temp	Manual	Auto, manual: Default +25.0 °C (entry)
- Cal temp	Manual	Auto, manual: Default +25.0 °C (entry)
• Sensoface	Default	Default, Individual
• Sensor monitoring details		
- Slope	Auto	Auto, Individual
Nominal	59.2 mV/pH	Can only be set with "Individual" selected
Min	53.3 mV/pH	
Max	61.0 mV/pH	
Message	Maint. request	Off, failure, maintenance request
- Zero point	Auto	Auto, Individual
Nominal	07.00 pH	Can only be set with "Individual" selected
Min	06.00 pH	
Max	08.00 pH	
Message	Maint. request	Off, failure, maintenance request
- Sensocheck Ref el	Auto	Auto, Individual
Nominal	5.0 k Ω	Can only be set with "Individual" selected
Min	3.1 k Ω	
Max	100.0 k Ω	
Message	Off	Off, failure, maintenance request
- Sensocheck Glass el	Auto	Auto, Individual (not for sensor type ISFET)
Nominal	120.0 M Ω	Can only be set with "Individual" selected
Min	28.6 M Ω	
Max	350.0 M Ω	
Message	Off	Off, failure, maintenance request
- Response time	Auto	Auto, Individual
Response time Max	0000 sec	
Message	Off	Off, failure, maintenance request
- Calcheck		Calcheck: checks the difference between calibration buffers and measured values
Meas distance Max	Auto	Auto, Individual
Message	3.20 pH Off	Off, failure, maintenance request

Parameter setting of EC 700

Note: HOLD mode active

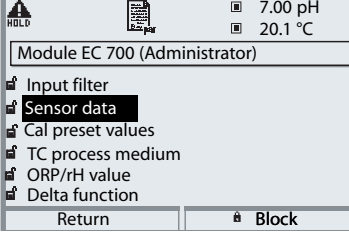
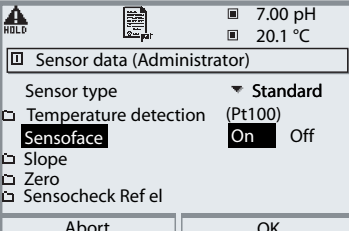
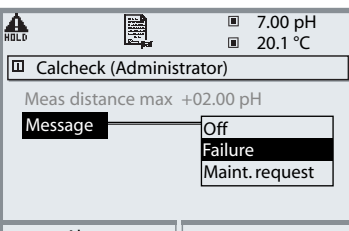
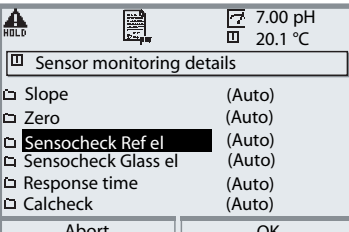
Menu	Display	Parameter selection
	  	<h3>Sensor data</h3> <p>Sensor data are preset depending on the sensor type. Gray display lines cannot be edited. Sensoface provides information on the sensor condition (evaluating the sensor data). Great deviations are signaled. Sensocheck can be switched off. The following parameters are monitored: Slope, zero, reference impedance (for ISFET sensors), glass impedance (pH electrodes), response time, CalCheck. The tolerance limits are displayed in gray. Limit violations can be signaled by a message (either "failure" or "maintenance request").</p>
		<h3>Sensor monitoring details</h3> <p>With "Auto" selected, the limits calculated by the analyzer are used (displayed in gray). With "Sensor monitoring Individual", the tolerance limits for the parameters are displayed in black and can be set.</p>

Graphical indication of sensor condition

Sensocheck must have been activated during parameter setting.

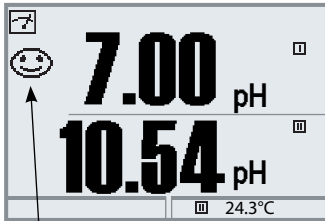

Sensocheck:

Automatic monitoring of glass and reference electrode

The “smileys” provide information on wear and required maintenance of the sensor (“friendly” - “neutral” - “sad”).

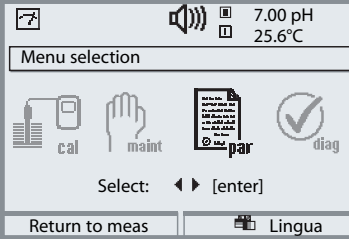
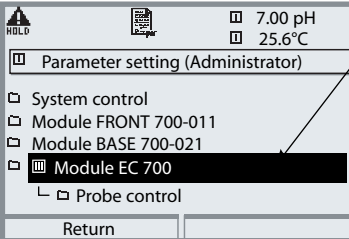
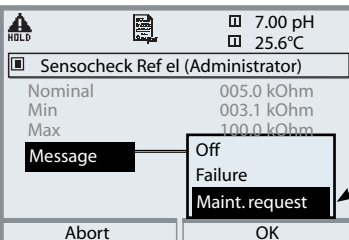
Menu	Display	Activate Sensocheck
	 <p>Select: ◀ ▶ [enter]</p> <p>Return to meas Lingua</p>  <p>Return</p>  <p>Abort OK</p>	<p>Open menu selection Select parameter setting Enter passcode (Administrator)</p> <p>Select (“EC 700”) module. Confirm with enter</p> <p>Select “Sensor data”. Confirm with enter. Then select “Sensocheck Ref el” (Fig.) Assign function and confirm with enter.</p>

Sensoface is "sad" ...

The "Diagnostics / pH module / Sensor network diagram" shows all current sensor parameters in a graphic diagram.

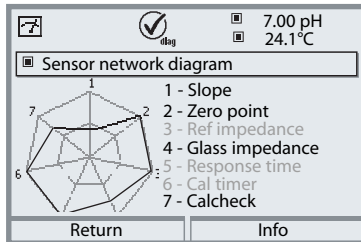

Sensor Network Diagram

"Diagnostics / pH module / Sensor network diagram".

Tolerance limit violations can be seen at a glance. Critical parameters (inner circle) are flashing. Parameters displayed in gray have been disabled during parameter setting or do not apply to the currently selected sensor.

Sensoface Criteria

Parameter	Standard*	Critical range
Slope	59,2	< 53.3 or > 61
Zero	7.00	< 6.00 or > 8.00
Reference impedance	Rcal **	< 0.3 Rcal or > 3.5 Rcal
Glass impedance	Rcal **	< 0.6 Rcal or > 100 KΩ+ 0.5 Rcal
Response time		
Fine		120 sec
Measures		80 sec
Coarse		60 sec
Calibration timer		When 80 % expired
Calcheck		Difference meas. value / buffer > 3.2 pH

* Applies to standard electrodes with pH = 7.00

** Rcal is determined during calibration

Parameter Setting of EC 700

Cal preset values

Note: HOLD mode active

Cal Preset Values

Parameter	Choices (default in bold print)	
• Calimatic buffer	Knick:	2.00 4.01 7.00 9.21
	Mettler-Toledo:	2.00 4.01 7.00 9.21
	Merck/Riedel:	2.00 4.00 7.00 9.00 12.00
	DIN 19267:	1.09 4.65 6.79 9.23 12.75
	NIST standard:	4.006 6.865 9.180
NIST technical:	1.68 4.00 7.00 10.01 12.46	
• Drift check	Fine:	1.2 mV/min (Abort after 180 sec)
	Standard:	2.4 mV/min (Abort after 120 sec)
	Coarse:	3.75 mV/min (Abort after 90 sec)
• Calibration timer Monitoring Calibration timer Adaptive cal timer	Auto , Off, Individual	
	0168h	Entry with "Individual"; Off = 0000
	Off , On	
• Cal tolerance band	Tolerance band check:	Off , On
	Tolerance Zero	+00.20 pH (entry)
	Tolerance Slope	+002.0 mV/pH (entry)
• ORP check	Test period:	010 s (entry)
	Test difference:	0010 mV (entry)

Tolerance Adjustment

(Additional function SW 700-005)

During calibration this function checks the zero and slope values and automatically performs an adjustment when the tolerance band is exceeded. The parameters are stored in the tolerance band recorder (Diagnostics menu).

Control via Probe Controller

(Parameter setting / Probe control / Cal preset values / Cal mode / Adjustment)

With "Cal tolerance band check" switched on, data are only taken over when they exceed the limits defined by the tolerance band.

SW 700-005: Tolerance Adjustment

Program flow

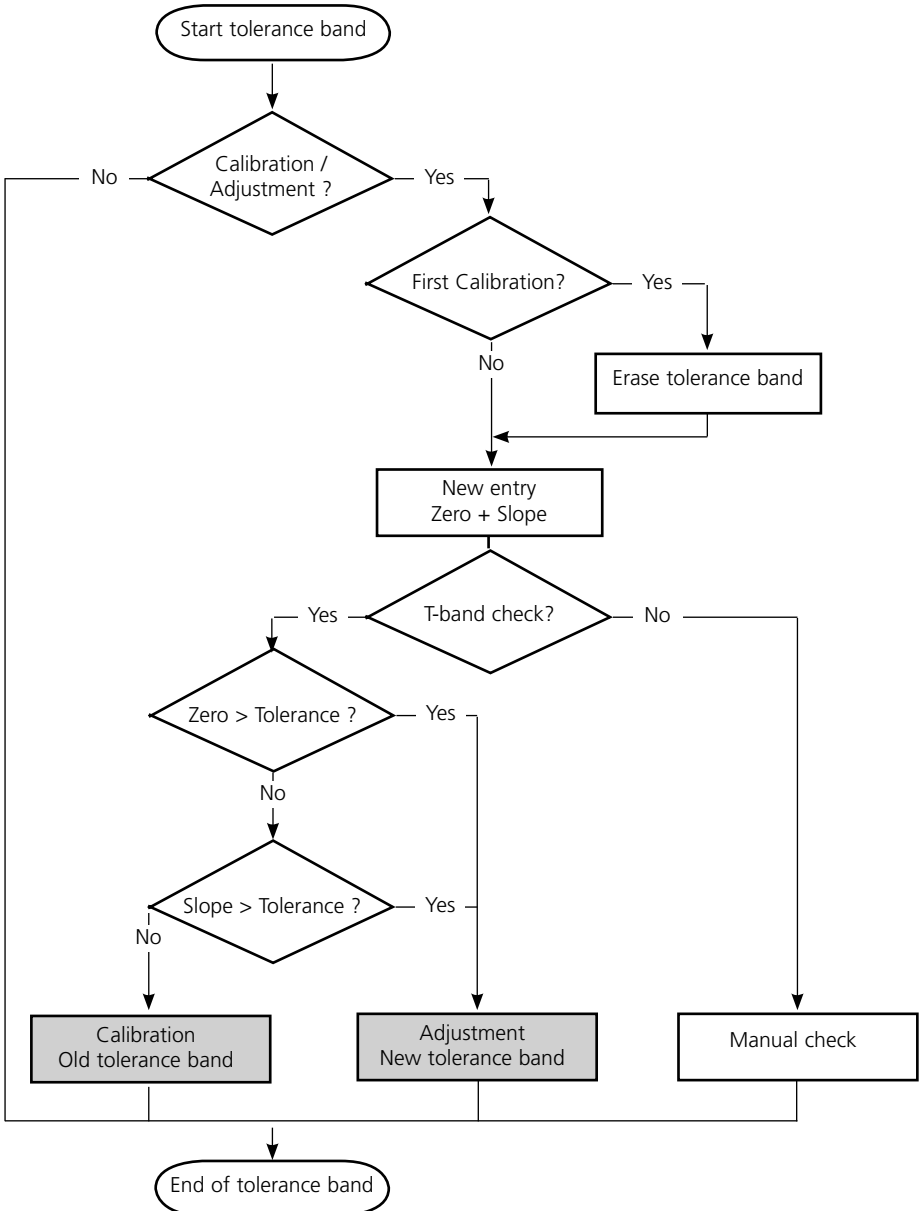

Activating the Cal Tolerance Band

Select menu: Parameter setting/System control/Release of options

Note: The TAN for releasing an additional function is only valid for the device with the corresponding serial number!

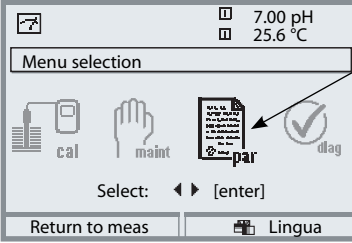
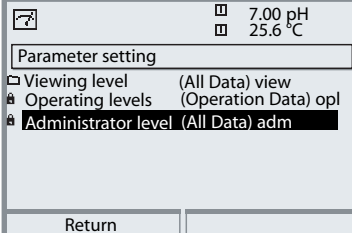
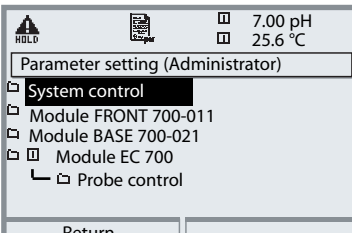
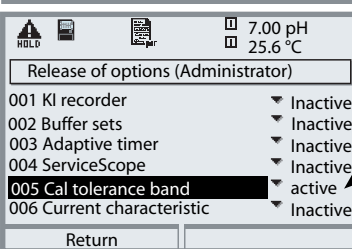
Menu	Display	Activate additional function
		<p>Menu selection Call up parameter setting. From the measuring mode: Press menu key to select menu. Select parameter setting using arrow keys, confirm with enter.</p>
		<p>Parameter setting Select Administrator level using arrow keys confirm with enter. Enter passcode and confirm (Passcode as delivered: 1989).</p>
		<p>Select System control using arrow keys, confirm with enter. Then select Release of options using arrow keys, confirm with enter.</p>
		<p>Release of options Select the additional function to be released ("Cal tolerance band"). Set option to "active". Enter the TAN at the prompt. (Note: The TAN is only valid for the device with the corresponding serial number, see previous page.) The option is available after the TAN has been entered.</p>

Parameter Setting of EC 700

Cal preset values: Calimatic buffer, Cal timer, Cal tolerance band

Note: HOLD mode active

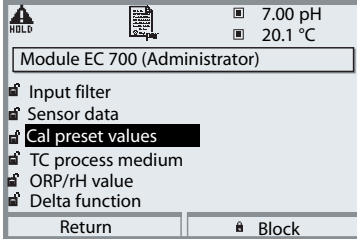
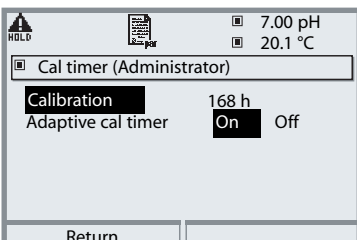
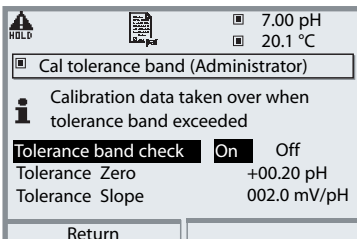
Menu	Display	Cal preset values
		<h3>Calimatic buffer</h3> <p>For automatic calibration, you must define the buffer set you want to use. For calibration, you must then use buffer solutions from this buffer set. The order does not matter. The selected buffer set with the nominal values of the individual buffer solutions is displayed in gray. The "Calimatic buffer" menu shows all buffer sets available. Select buffer set with enter.</p>
		<h3>Calibration timer</h3> <p>Entry of the time interval until the next due calibration.</p> <h4>Adaptive calibration timer</h4> <p>Automatically reduces the time until the next due calibration when the electrode is exposed to high stress (temperature, extreme pH values).</p>
		<h3>Tolerance adjustment</h3> <p>If the measured value leaves the tolerance band specified here for zero and slope, an adjustment is automatically performed during calibration.</p>

Parameter Setting of EC 700

TC process medium, ORP/rH value, delta function:

Default settings and selection range

Parameter	Choices (default in bold print)
• TC process medium	Off , linear, ultrapure water, table Linear: enter temperature factor +XX.XX %/K
• ORP/rH value	
Reference electrode	Ag/AgCl, KCl 1 mol/l Ag/AgCl, KCl 3mol/l Hg, Tl/TlCl, KCl 3.3 mol/l Hg/Hg ₂ SO ₄ , K ₂ SO ₄ sat
ORP conversion to SHE	No , Yes
Calculate rH with factor	No , entry of factor
• Delta function	Off , pH, mV+ORP or rH: entry of delta value

Temperature compensation of process medium

Linear temperature compensation, reference temp fixed at 25 °C

$$\text{pH}_{(25\text{ }^{\circ}\text{C})} = \text{pH}_M + \text{TC}/100 \% (25\text{ }^{\circ}\text{C} - T_M)$$

$$\text{pH}_{(25\text{ }^{\circ}\text{C})} = \text{pH value compensated to } 25\text{ }^{\circ}\text{C}$$

$$\text{pH}_M = \text{Measured pH value (temp-corrected)}$$

$$\text{TC} = \text{Temperature factor } [\%/\text{K}]$$

$$T_M = \text{Measured temperature } [^{\circ}\text{C}]$$

Parameter Setting of EC 700

TC process medium

Note: HOLD mode active

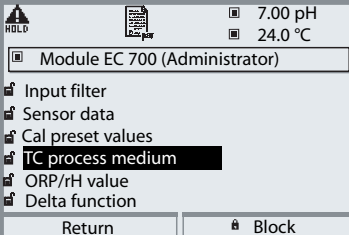
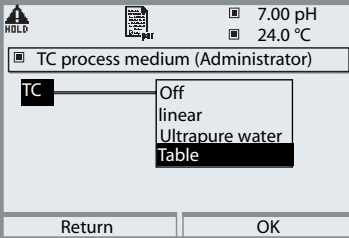
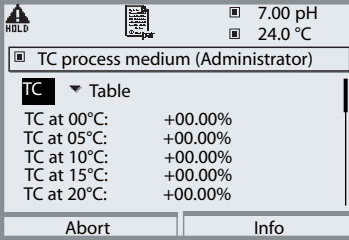
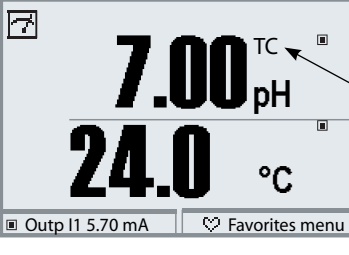
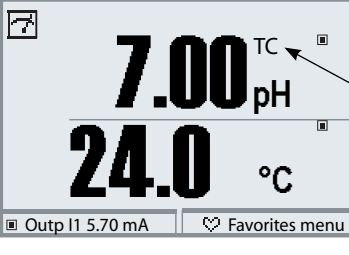
Menu	Display	TC process medium
	  	<p>TC process medium</p> <p>You can choose from:</p> <ul style="list-style-type: none"> • Linear (entry of TC coefficient) • Ultrapure water • Table <p>When measuring media with a known temperature behavior, the output pH value can be corrected using a chart. TC can be entered in 5 °C steps for temperatures between 0 and +95 °C. Then, the output pH value is corrected by the corresponding TC value depending on the measuring temperature. Intermediate values are linearly interpolated. In the case of lower or higher temperatures (< 0 °C or > +95 °C), the last chart value is used for calculation. If the delta function has been activated (see Pg 42) simultaneously with temperature compensation, the temperature is compensated first and then the delta value is subtracted.</p>
		<p>When the TC correction for process medium is switched on, "TC" appears in the display in measuring mode.</p>

Parameter Setting of EC 700

ORP/rH value, delta function

Note: HOLD mode active

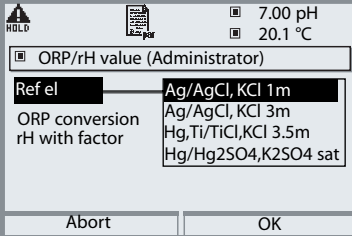
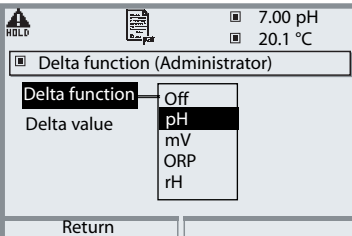
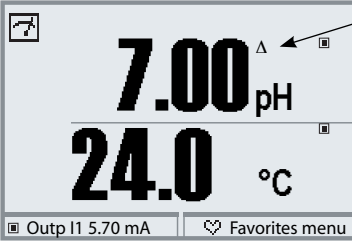
Menu	Display	ORP/rH value, delta function
	  	<p>ORP/rH value</p> <ul style="list-style-type: none"> Select type of reference electrode: <ul style="list-style-type: none"> Ag/AgCl, KCl 1 mole/l (Silver/silver chloride) Ag/AgCl, KCl 3 moles/l (Silver/silver chloride) Hg, Ti/TiCl, KCl 3.3 moles/l (Thalamid) Hg/Hg₂SO₄, K₂SO₄ saturated (mercury sulfate) ORP conversion to SHE Calculate rH with factor <p>Delta function</p> <p>When a delta value is entered, the system calculates the difference</p> <p>Output value = measured value – delta value</p> <p>The output value controls all outputs and is shown on the display. When the delta function has been activated simultaneously with temperature compensation, the temperature is compensated first and then the delta value is subtracted.</p> <p>When delta function is switched on, “Δ” appears in the display in measuring mode.</p>

Parameter Setting of EC 700

Messages: Default settings and selection range



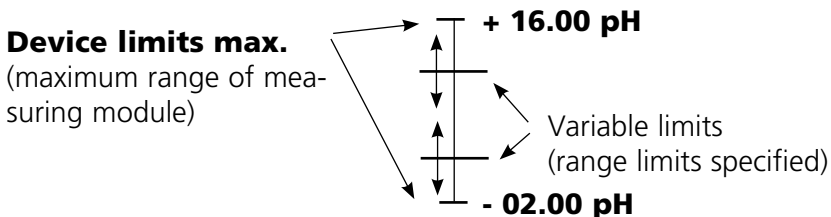

Parameter	Choices (default in bold print)	
• pH value	Off, device limits max. ,	Variable limits: - Failure Limit LO - Warning Limit LO - Warning Limit HI - Failure Limit HI
• ORP value	Off , device limits max.,	Variable limits: - Failure Limit LO - Warning Limit LO - Warning Limit HI - Failure Limit HI
• rH value	Off , device limits max.,	Variable limits: - Failure Limit LO - Warning Limit LO - Warning Limit HI - Failure Limit HI
• Temperature	Off, device limits max. ,	Variable limits: - Failure Limit LO - Warning Limit LO - Warning Limit HI - Failure Limit HI
• mV value	Off , device limits max.,	Variable limits: - Failure Limit LO - Warning Limit LO - Warning Limit HI - Failure Limit HI

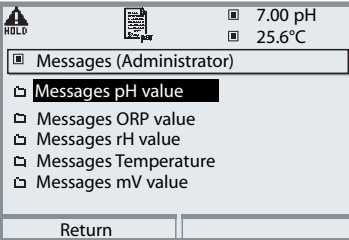
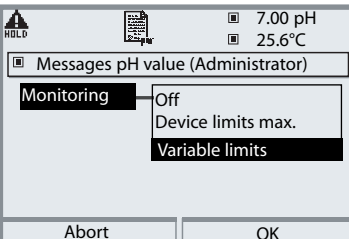
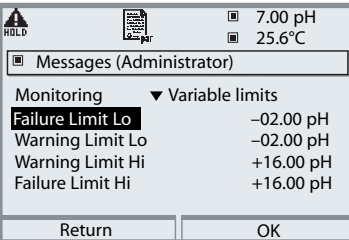

Parameter Setting of EC 700

Messages

Note: HOLD mode active

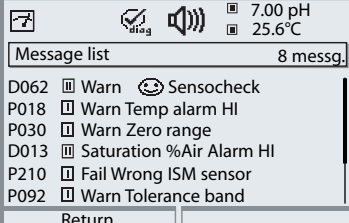
Menu	Display	Messages
	  	<p>Messages</p> <p>All parameters determined by the measuring module can generate messages.</p> <p>Device limits max.:</p> <p>Messages are generated when the process variable (e.g. pH) is outside the measurement range. The “Failure” icon is displayed, the NAMUR failure contact is activated (BASE module, factory setting: contact K4, N/C contact). The current outputs can signal a 22 mA message (user defined).</p> <p>Variable limits:</p> <p>For the “failure” and “warning” messages you can define upper and lower limits for message generation.</p> <p>Message icons</p> <ul style="list-style-type: none">  Failure (Failure limit HiHi/LoLo)  Maintenance (Warning limit Hi/Lo)  Limit indication (here: lower range)
		<p>Diagnostics menu</p> <p>When the “Maintenance” or “Failure” icons are flashing in the display, you should call up the Diagnostics menu. The messages are displayed in the “Message list”.</p>

Logbook, Factory Setting

Parameter setting/System control/Logbook

Note: HOLD mode

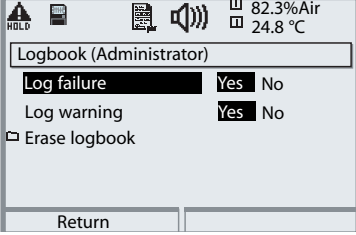
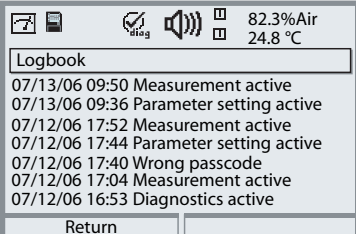
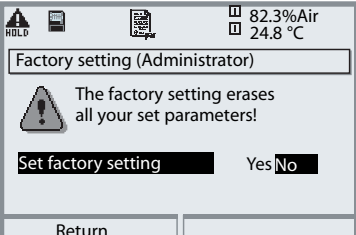
Menu	Display	Logbook, factory setting
	  	<p>Logbook</p> <p>Select which messages are to be logged in the logbook. The last 50 events are recorded with date and time.</p> <p>This permits quality management documentation to ISO 9000 et seq.</p> <p>The logbook can be called up from the diagnostics menu (Fig.).</p> <p>Additional function SW 700-104: Extended logbook for recording data on SmartMedia card (TAN).</p> <p>Factory setting</p> <p>Allows resetting the parameters to their factory setting.</p> <p>When this menu is opened, the analyzer displays a warning (Fig.).</p>

Current Outputs, Contacts, OK Inputs

Select menu: Parameter setting/Module BASE

Note: HOLD mode active

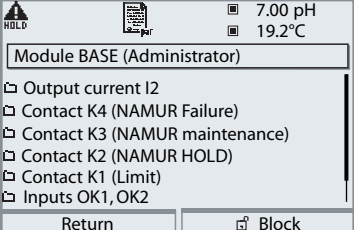
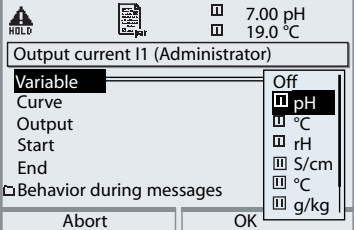
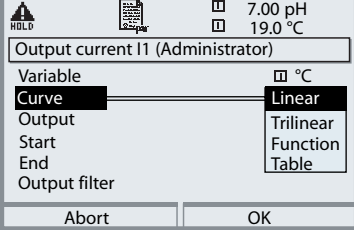
Menu	Display	Parameter setting BASE module
		<p>Configure current output</p> <ul style="list-style-type: none"> • Call up parameter setting • Enter passcode • Select "Module BASE" • Select "Output current ..."
		<ul style="list-style-type: none"> • Select measured variable
		<ul style="list-style-type: none"> • Select Curve, e.g. "linear": The measured variable is represented by a linear output current curve. The desired range of the measured variable is specified by the values for "Start" and "End".

Assignment of Measured Values: Start (4 mA) and End (20 mA)

Example 1: Range pH 0 - 14

Example 2: Range pH 5 - 7

Advantage: Higher resolution in range of interest

Output current [mA]

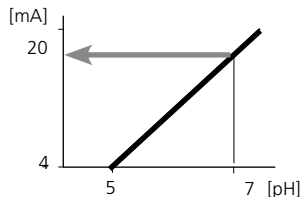
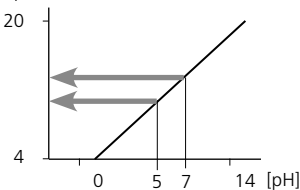

Current Outputs: Characteristics

Select menu: Parameter setting/Module BASE

- **Linear characteristic**

The measured variable is represented by a linear output current curve.

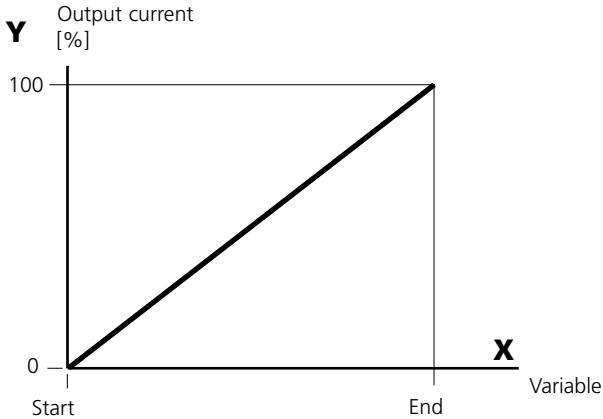

- **Trilinear characteristic**

Two additional corner points must be entered:

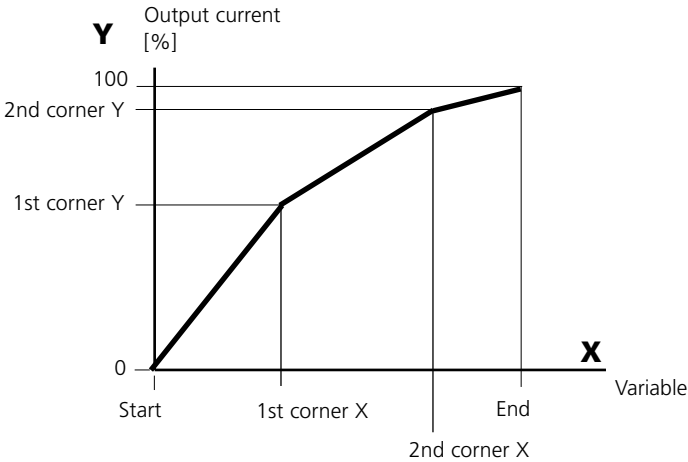

- **Note: Bilinear characteristic**

For a bilinear characteristic, identical parameters are entered for the two corner points (1st corner, 2nd corner).

• Function characteristic

Nonlinear output current characteristic: allows measurements over several decades, e.g. measuring very low values with a high resolution and high values with a low resolution.

Required: Entering a value for 50 % output current.

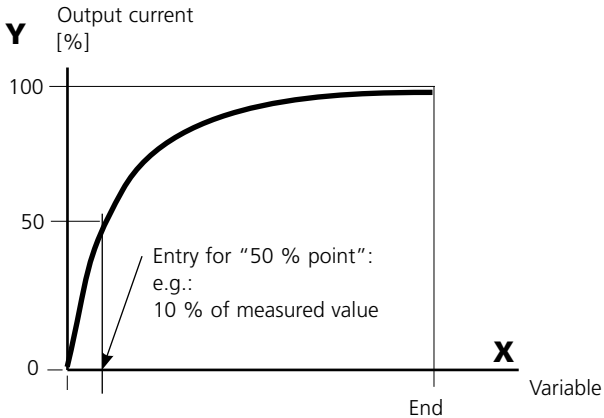

Equation

$$\text{Output current (4 ... 20 mA)} = \frac{(1+K)x}{1+Kx} 16 \text{ mA} + 4 \text{ mA}$$

$$K = \frac{E + S - 2 * X50\%}{X50\% - S} \qquad x = \frac{M - S}{E - S}$$

S: Start value at 4 mA

X50%: 50% value at 12 mA (output current range 4 to 20 mA)

E: End value at 20 mA

M: Measured value

Logarithmic output curve over one decade:

S: 10 % of maximum value

X50%: 31.6 % of maximum value

E: Maximum value

Logarithmic output curve over two decades:

S: 1 % of maximum value

X50%: 10 % of maximum value

E: Maximum value

Output Filter

Time constant.

Time constant of output filter

To smoothen the current output, a low-pass filter with adjustable time constant can be switched on. When there is a jump at the input (100 %), the output level is at 63 % after the time constant has been reached.

The time constant can be set from 0 to 120 sec. If the time constant is set to 0 sec, the current output follows the input.

Notice

The filter only acts on the current output and the current value of the secondary display, not on the measurement display, the limit values, or the controller!

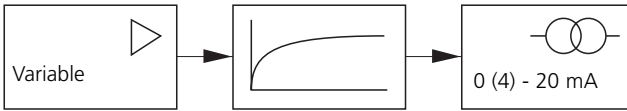

Time constant 0 to 120 s

NAMUR Signals: Current Outputs

Behavior during messages: HOLD, 22 mA signal

Behavior during messages

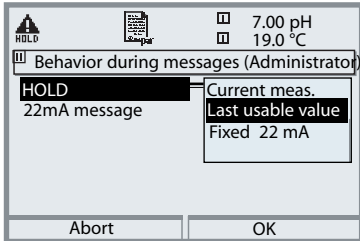

Depending on the parameter setting ("Messages") the current outputs switch to:

- Currently measured value
- Last measured value (HOLD function)
- Fixed value (22 mA)

In the case of a fault a 22 mA signal can be generated for the selected process variable (1st primary value).

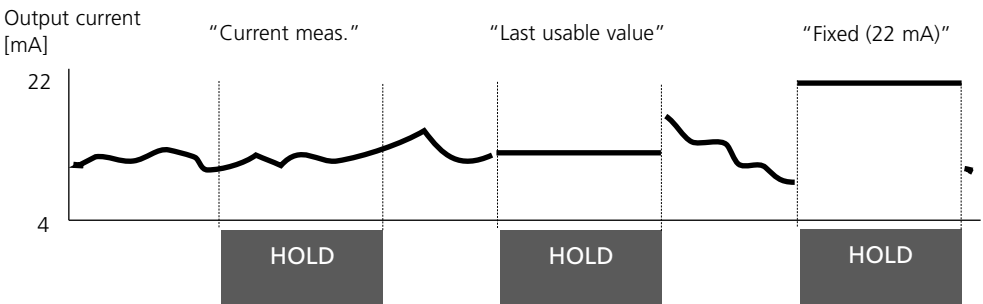

Message when the current range is exceeded

As delivered, the "Maintenance request" (Warn) message is generated when the current range is exceeded ($< 3.8 \text{ mA}$ or $> 20.5 \text{ mA}$).

This setting can be changed in the Parameter setting menu of the respective measuring module at "Messages".

To generate a "Failure" message, the limit value monitoring must be set to "Variable limits":

Parameter setting - <measuring module> - Messages - Variable limits - Failure limit ...

Enter the same values for the failure limits as for the current output:

Parameter setting - Module BASE - Output current - Variable Start / End.

NAMUR Signals: Relay Contacts

Failure, Maintenance Request, HOLD (Function Check)

As delivered, the floating relay outputs of the BASE module are assigned to the NAMUR signals:

Failure	Contact K4, normally closed (signaling current failure)
Maint. request	Contact K3, normally open contact
HOLD	Contact K2, normally open contact

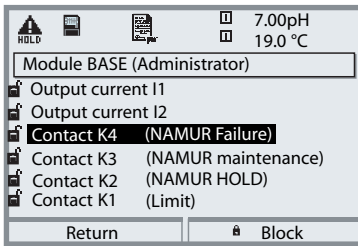

NAMUR signals: Factory setting of contacts

- Select parameter setting:
 - Administrator level
 - Select "Module BASE" (Fig.)
- You can define a delay time for "Maintenance request" and "Failure", resp. If an alarm message is released, the contact will only be activated after expiry of this delay time.

Failure is active

when a value has exceeded (or fallen below, resp.) a preset "Failure Limit Hi" or "Failure Limit Lo", when the measured value is out of range, or in the event of other failure messages. That means that the equipment no longer operates properly or that process parameters have reached a critical value. Failure is disabled during "HOLD" (Function check).

Maintenance request is active

when a value has exceeded (or fallen below, resp.) a preset "Warning Limit Hi" or "Warning Limit Lo", or when other warning messages have been activated. That means that the equipment is still operating properly but should be serviced, (or that process parameters have reached a value requiring intervention).

Failure is disabled during "HOLD" (function check).

HOLD is active:

- during calibration
- during maintenance (current source, meas. point maintenance)
- during parameter setting at the Operator level and the Administrator level
- during an automatic rinsing cycle.

Relay Contacts: Protective Wiring

Protective Wiring of Relay Contacts

Relay contacts are subjected to electrical erosion. Especially with inductive and capacitive loads, the service life of the contacts will be reduced. For suppression of sparks and arcing, components such as RC combinations, nonlinear resistors, series resistors and diodes should be used.

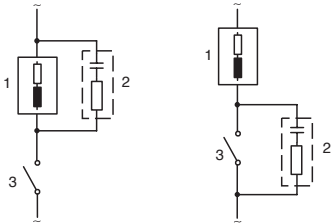

Typical AC applications with inductive load

- 1 Load
- 2 RC combination, e.g. RIFA PMR 209
Typical RC combinations
e.g.
Capacitor 0.1 μF ,
Resistor 100 ohms / 1 W
- 3 Contact

Caution!

Make sure that the maximum ratings of the relay contacts are not exceeded even during switching!

Information Concerning Relay Contacts

As delivered, the relay contacts are suitable for low signal currents (down to approx. 1mA). If currents above approx. 100 mA are switched, the gold plating is destroyed during the switching process. After that, the contacts will not reliably switch low currents.

Relay Contacts

Parameter setting/Module BASE/Relay contacts

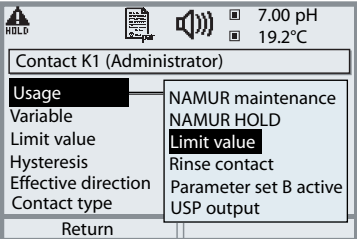
Menu	Display	Setting the relay contacts
		<p>Relay contacts, usage</p> <ul style="list-style-type: none"> • Call up parameter setting • Enter passcode • Select "Module BASE" • Select "Contact ..." • "Usage" (Fig.)

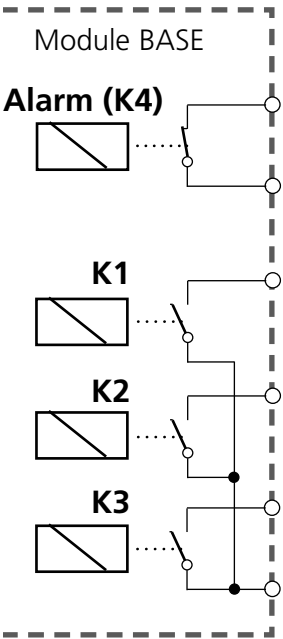

Contact assignment:
See terminal plate of
BASE module

The BASE module provides 4 relay contacts (max. AC/DC rating 30 V / 3 A each). Contact K4 is provided for failure message. The switching behavior (normally open or normally closed), as well as a switch-on or switch-off delay can be defined.

Default settings of the user-definable relay contacts of the BASE module:

- K3: NAMUR maintenance request
- K2: NAMUR HOLD (function check)
- K1: Limit

K1-K3 are user definable ("Usage"):

- NAMUR maintenance
- NAMUR HOLD
- Limit value
- Rinse contact
- Parameter set B active
- USP output (Cond module only)
- K1 rec. active
- Sensoface (Messages on Pg 35, 36)
- Controller alarm (from EC 700, see Pg 126)

Rinse Contact

Parameter setting/Module BASE/Relay contacts/Usage/Rinse contact

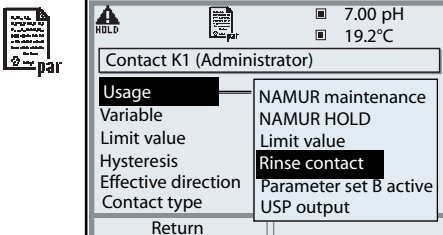
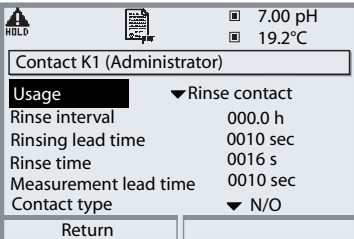
Menu	Display	Configuring the rinse contact
	<p>Relay contacts, usage</p> <ul style="list-style-type: none"> • Call up parameter setting • Enter passcode • Select "Module BASE" • Select contact e.g. K1 • "Rinse contact" (Fig.) 	
	<p>Configuring the rinse contact</p> <ul style="list-style-type: none"> • Set rinse interval • Set rinse duration • During the defined "lead time" the "HOLD" mode is active. • Select contact type (e.g. "N/O") 	

Please note when configuring the "Rinse contact" function

- "HOLD" mode (e.g. during parameter setting) delays the execution of the "Rinse contact" function.
- Up to 3 rinse functions (contacts K1 ... K3) can be configured independently.
- The individual rinse functions are not synchronized with each other.

Time Response

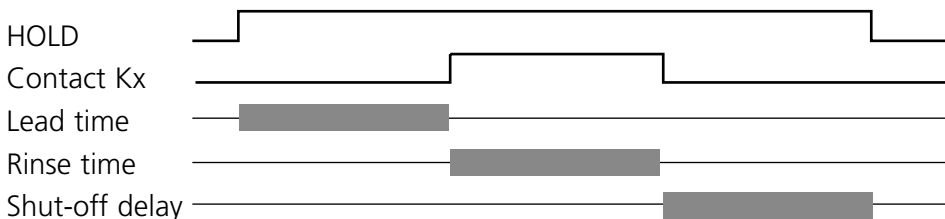

Limit Value, Hysteresis, Contact Type

Parameter setting/Module BASE/Relay contacts/Usage

Menu	Display	Usage as limit value
		Relay output: Limit <ul style="list-style-type: none"> • Call up parameter setting • Enter passcode • Select "Module BASE" • Select "Contact ..." • "Usage: Limit" (Fig.)

Limit value ▼

Effective direction min

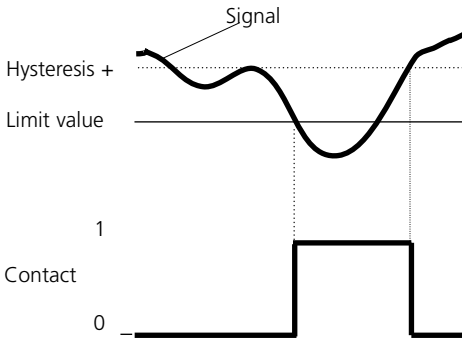

Limit value ▲

Effective direction max

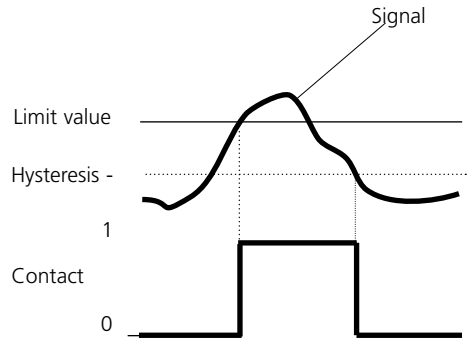

Icons in the measurement display:

Measured value exceeds limit: ▲ Measured value falls below limit: ▼

Hysteresis

Tolerance band around the limit value, within which the contact is not actuated. Serves to obtain appropriate switching behavior at the output and suppress slight fluctuations of the measured variable (Fig.)

Contact type

Specifies whether the active contact is closed (N/O) or open (N/C).

OK1, OK2 Inputs: Specify Level

Parameter setting/Module BASE/Inputs OK1, OK2

Note: HOLD mode (setting: BASE module)

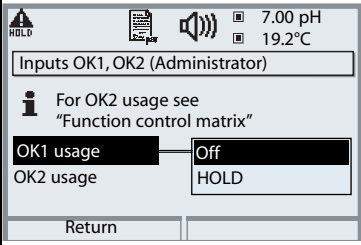
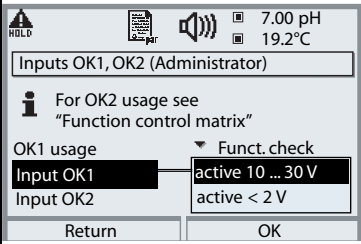
Menu	Display	Setting the OK inputs
	 <p>Inputs OK1, OK2 (Administrator)</p> <p>For OK2 usage see "Function control matrix"</p> <p>OK1 usage: Off</p> <p>OK2 usage: HOLD</p> <p>Return</p>	<p>OK1 usage</p> <ul style="list-style-type: none"> • Call up parameter setting • Enter passcode • Select "Module BASE" • Select "Inputs OK1/OK2" • Select "OK1 usage"
	 <p>Inputs OK1, OK2 (Administrator)</p> <p>For OK2 usage see "Function control matrix"</p> <p>OK1 usage: active 10 ... 30 V</p> <p>Input OK1: active 10 ... 30 V</p> <p>Input OK2: active < 2 V</p> <p>Return OK</p>	<p>OK1/OK2 switching level</p> <ul style="list-style-type: none"> • Call up parameter setting • Enter passcode • Select "Module BASE" • Select "Inputs OK1/OK2" • Specify active switching level

The BASE module provides 2 digital inputs (OK1, OK2). The following functions (depending on the parameter setting) can be started via a control signal:

- OK1: "Off" or "HOLD" (Function check)
- OK2: Select: System control / Function control matrix ("Off", "Parameter set A/B", "Start KI recorder")

The switching level for the control signal must be specified: (active 10...30 V or active < 2 V).

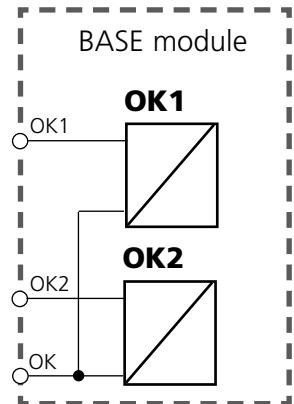

Switching Parameter Sets via OK2

Parameter setting / System control / Function control matrix

Note: HOLD mode (setting: BASE module)

Parameter sets

2 complete parameter sets (A, B) can be stored in the analyzer.

You can switch between the parameter sets using the OK2 input.

The currently activated set can be signaled by a relay contact.

An icon in the measurement display shows which parameter set is active:

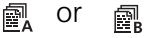

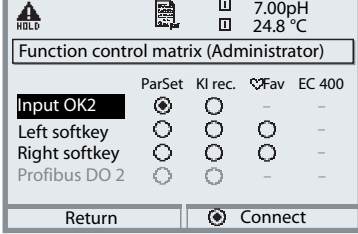
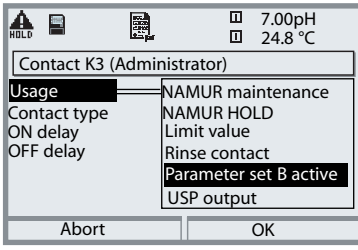
Menu	Display	Parameter sets
		Selecting parameter set (A, B) via OK2 input <ul style="list-style-type: none"> • Call up parameter setting • System control • Function control matrix • Select “OK2” • Connect “Parameter set A/B”
		Signaling active parameter set via relay contact <ul style="list-style-type: none"> • Call up parameter setting • BASE module • Select contact • Usage: “Parameter set ...”.

Notice





The selection has no effect when working on SmartMedia card with SW 700-102.

Parameter Setting: Probe Control

EasyClean 400(X)

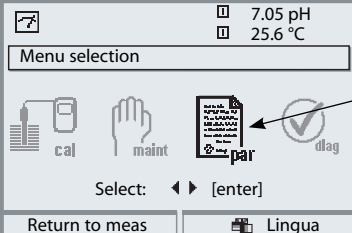
Functional Capabilities

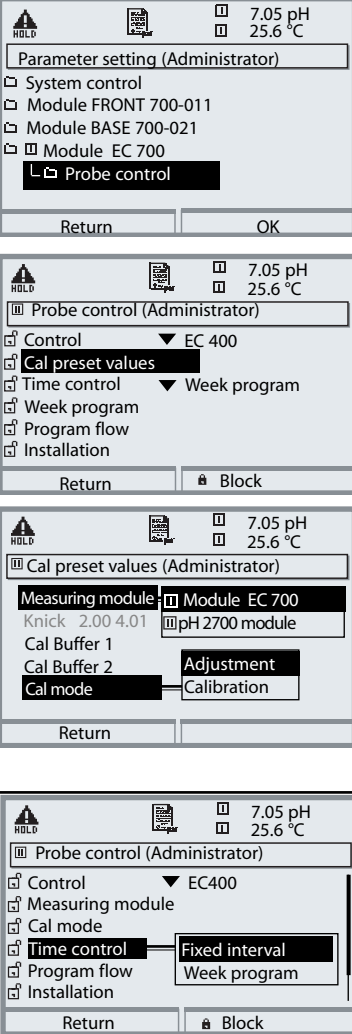
Setting	Adjustable parameters	Page
<ul style="list-style-type: none"> Control Cal preset values <ul style="list-style-type: none"> Cal Buffer 1 Cal Buffer 2 Cal mode 	<p>EC 400, Off</p> <p>Buffer set as configured in the EC 700</p> <p>Calimatic (automatic) or selection of a buffer</p> <p>Calimatic (automatic) or selection of a buffer</p> <p>Adjustment, Calibration</p>	Pg 60
<ul style="list-style-type: none"> Time control 	<p>Fixed interval, Week program:</p> <p>Fixed interval: Select program, interval</p> <p>Week program: Configuration of program flows</p>	Pg 61
<ul style="list-style-type: none"> Program flow 	Individual adaptation of program steps for: Cleaning, Cal 2point, Cal 1point, Service, Parking, User 2, User 1	Pg 62
<ul style="list-style-type: none"> Installation <ul style="list-style-type: none"> Ext. control (DCS) 	<p>Off, On</p> <p>DCS inputs (36...39) active 10...30 V or active < 2 V</p> <p>M/S input (42/43) active 10...30 V or active < 2 V</p> <p>A/M input (40/41) active 10...30 V or active < 2 V</p> <p>Output DCS 34 Measuring, Alarm</p> <p>DCS outputs (31...34) N/O, N/C</p>	<p>Pg 73</p> <p>Pg 74</p>
<ul style="list-style-type: none"> Sensor detection 	On, Off	
<ul style="list-style-type: none"> Access manual control 	Access code required. All valves can be actuated separately.	
<ul style="list-style-type: none"> Probe <ul style="list-style-type: none"> Move time max. Sealing water Max. wear counter 	<p>InTrac</p> <p>Adjustable; default setting 0015 s</p> <p>On, Off</p> <p>Entry (xxxx)</p>	
<ul style="list-style-type: none"> Rinse water 	Monitoring: Off , Process value, Temperature	
<ul style="list-style-type: none"> Media adapter (I ... III) (up to 3x metering pump) 	Each: Medium, Displaced volume, Residual volume, Monitoring of medium (Off / Process value / Temperature)	
<ul style="list-style-type: none"> Additional media (1 ... 2) 	Monitoring of medium (Off, Process value, Temperature)	
<ul style="list-style-type: none"> Start up 	Yes, No	Pg 79

Menu	Display	Parameter setting EC 400
		<p>Call up parameter setting</p> <p>From the measuring mode: Press menu key to select menu. Select parameter setting using arrow keys, confirm with enter.</p>
		<p>Select "Probe control / EC 400". Icons to assign the measured values displayed:</p> <ul style="list-style-type: none">  specifies module slot I  specifies module slot II <p>Cal preset values EC 400</p> <ul style="list-style-type: none"> • Select measuring module: Select the pH module for evaluation with the EC 400 controller (only if equipped with more than 1 pH module). <p>Select cal mode</p> <ul style="list-style-type: none"> • Adjustment: The values determined by a calibration are taken over. • Calibration: The values determined by a calibration are logged, but not taken over. <p>Time control</p> <ul style="list-style-type: none"> • Fixed interval (3): Specify times (000.0 h ... xxx.x h) (Please note: 000.1 h = 6 min) • Week program: Specify weekday

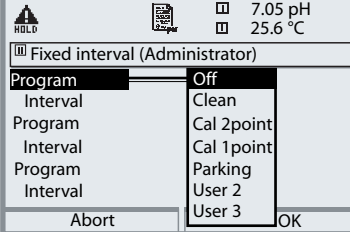
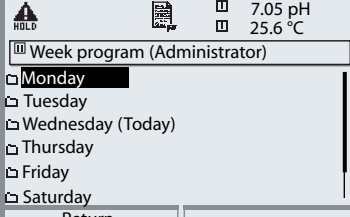
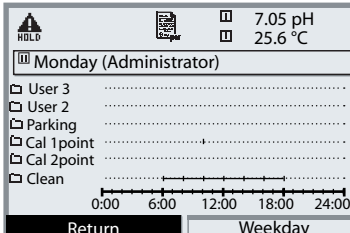
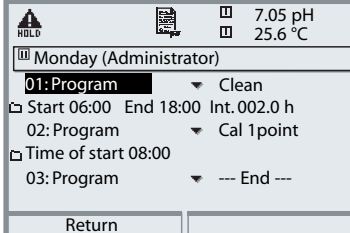
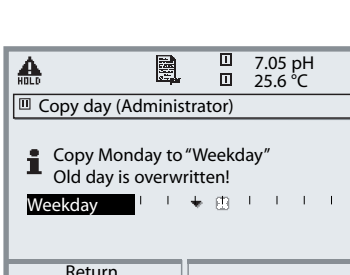
Menu	Display	Time control configuration
		<p>Time control: Fixed interval</p> <p>The “Fixed interval” menu allows selection of up to three programs. An individual time interval can be assigned to each program.</p>
		<p>Time control: Week program</p> <p>In this menu you can View, Edit and Copy.</p>
		<p>Displays shows the configured program sequences over the day</p>
		<p>Edit allows selection of up to 10 programs per day and you can choose between “Individual start” or “Interval” (the program is executed within a start and an end time at a specified interval).</p>
		<p>Copy allows taking over a configured program for another weekday. (Further editing is possible.)</p>

Parameter Setting: Program Flows

Cleaning, Continuous, Media monitoring off

Display text	Time [s]
01: Probe in SERVICE	
02: Cleaning agent*	0020 s
03: Rinse water ON	0060 s
04: Rinse water OFF	0002 s
05: Purge air ON*	0010 s
06: Purge air OFF*	0002 s
07: Probe in MEASURE	0005 s
08: Program end	

*: Text can be edited

Cleaning (continuous) can also be started via a DCS input signal at input BIN1 of the EC 400 probe controller.

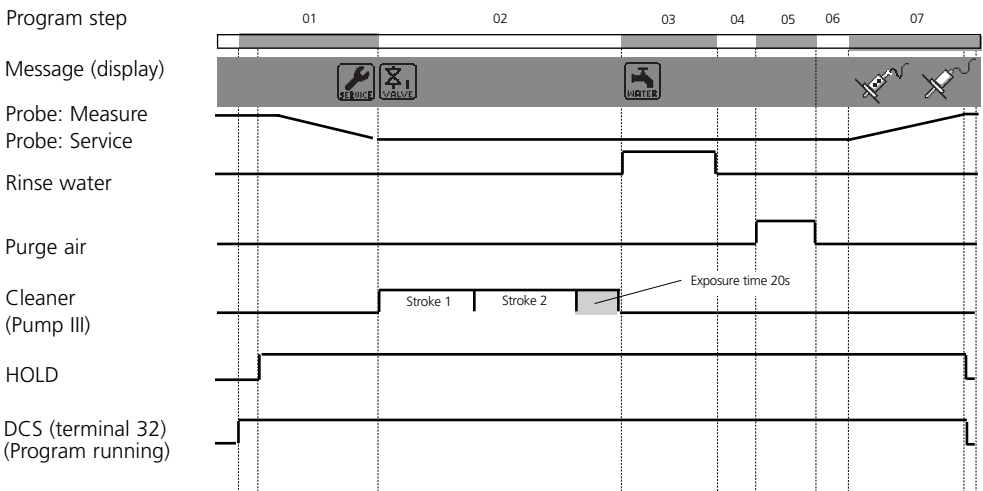

[1]

Parameter Setting: Program Flows

Cal 2point, Continuous, Media monitoring off

Display text	Time [s]	
01: Probe in SERVICE		
02: Cleaning agent*	0020 s	
03: Rinse water ON	0060 s	
04: Rinse water OFF	0002 s	
05: Purge air ON*	0010 s	
05: Purge air OFF*	0002 s	
07: Buffer 7.00*	0000 s	allows programming a calibration delay
08: Cal Buffer 1		
09: Rinse water ON	0010 s	
10: Rinse water OFF	0002 s	
11: Purge air ON*	0010 s	
12: Purge air OFF*	0002 s	
13: Buffer 4.01*	0000 s	allows programming a calibration delay
14: Cal Buffer 2		
15: Rinse water ON	0010 s	
16: Rinse water OFF	0002 s	
17: Purge air ON*	0010 s	
18: Purge air OFF*	0002 s	
19: Probe in MEASURE	0005 s	allows programming an extended HOLD period
20: Program end		

*: Text can be edited

Cal 2point (continuous) can also be started via a DCS input signal at input BIN2 of the EC 400 probe controller.

Program step

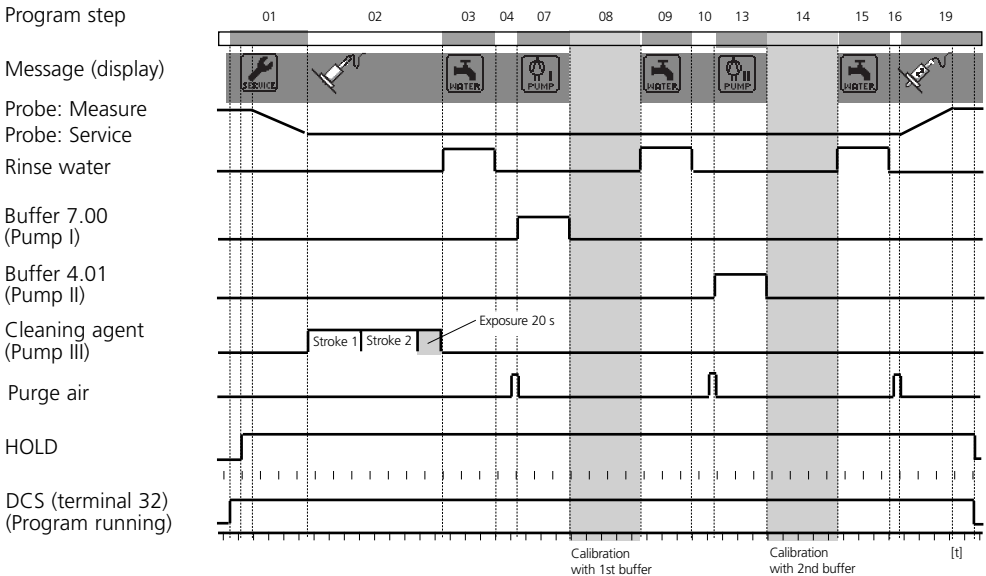

Parameter Setting: Program Flows

Cal 1point, Continuous, Media monitoring off

Display text	Time [s]
01: Probe in SERVICE	
02: Cleaning agent*	0003 s
03: Rinse water	0010 s
04: Rinse water	0002 s
05: Purge air ON*	0010 s
06: Purge air OFF*	0002 s
07: Buffer 7.00*	0000 s allows programming a calibration delay
08: Cal Buffer 1	
09: Rinse water	0010 s
10: Rinse water	0002 s
11: Purge air ON*	0010 s
12: Purge air OFF*	0002 s
13: Probe in MEASURE	0005 s allows programming an extended HOLD period
14: Program end	

*: Text can be edited

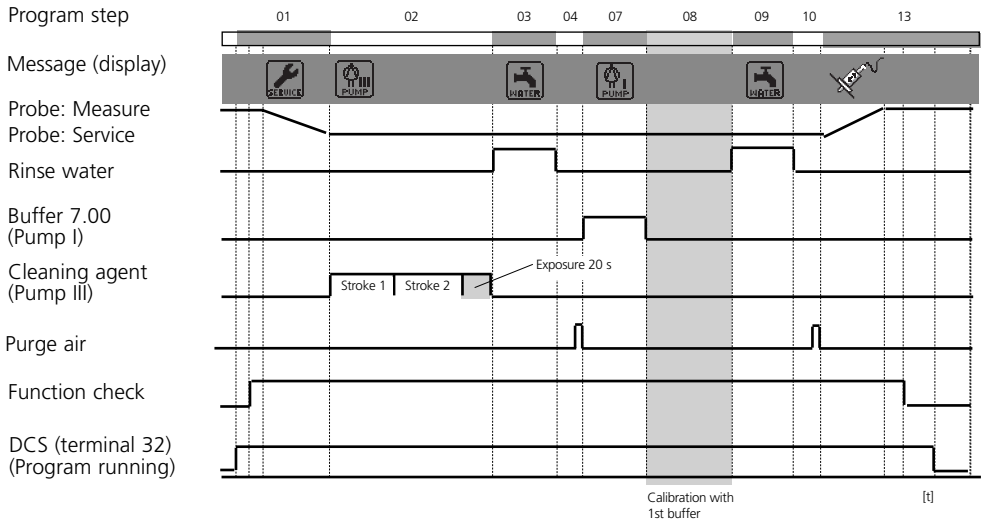

Park Program: Wait Position

The park program includes the programming step “Wait position”. When the program is started via the DCS inputs BIN 1 ... BIN 3 on the EC 400, the program will be executed until the “Wait position” is reached. There it stops until the signal status at the DCS inputs changes.

- The program is started via the DCS inputs and remains in “Wait position” until the assignment of the DCS inputs changes:

DCS inputs BIN 1 ... BIN 3
of EC 400

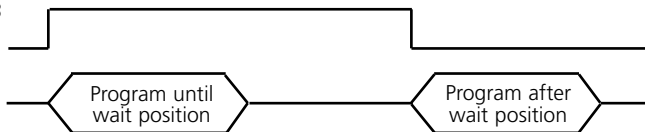

- The program is started by a short signal at the DCS inputs: Wait position is skipped.

DCS inputs BIN 1 ... BIN 3
of EC 400

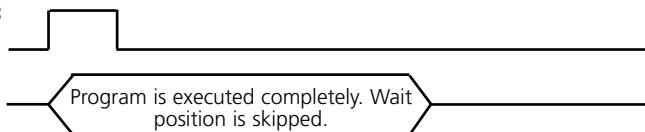

Notice:

If the programs are started by the premium line transmitter M 700(X) from the Calibration or Maintenance menu, the wait position will be skipped.

.....

Parameter Setting: Program Flows

Parking

Display text	Time [s]	
01: Probe in SERVICE		
02: Cleaning agent*	0020 s	The "Park" program can be started via Bin 3. The program remains in "Wait position" until the start status at Bin 1..3 is changed
03: Rinse water ON	0060 s	
04: Rinse water OFF	0002 s	
05: Purge air ON*	0010 s	
05: Purge air OFF*	0002 s	
07: Buffer 7.00		
08: Wait position	> position will be held until next command (e.g., DCS)	
09: Rinse water ON	0010 s	
10: Rinse water OFF	0002 s	
11: Purge air ON*	0010 s	
12: Purge air OFF*	0002 s	
13: Probe in MEASURE	0005 s	allows programming an extended HOLD period
14: Program end		

*: Text can be edited

Parking is started via a DCS input signal at input BIN3 of the EC 400 probe controller.

Program step

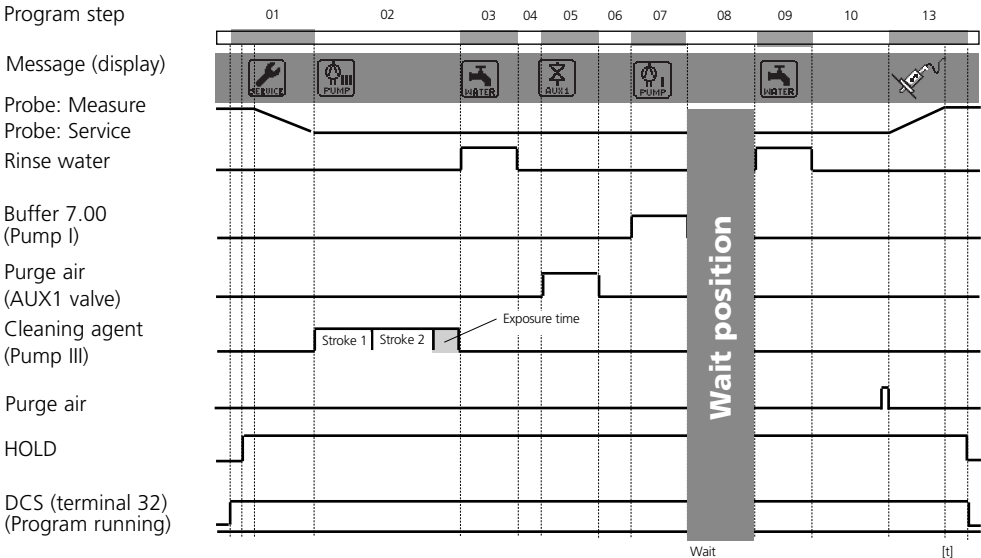

Parameter Setting: Program Flows

Measurement, Short-time, Media monitoring off

Display text	Time [s]
01: Rinse water ON	0010 s
02: Rinse water OFF	0002 s
05: Purge air ON*	0010 s
05: Purge air OFF*	0002 s
03: Probe in MEASURE	0005 s
04: Meas duration	0030 s
05: Probe in SERVICE	
06: Cleaning agent*	0020 s
07: Rinse water ON	0060 s
08: Rinse water OFF	0002 s
05: Purge air ON*	0010 s
05: Purge air OFF*	0002 s
09: Program end	

*: Text can be edited

Measurement (short-time) can also be started via a DCS input signal at input BIN1 of the EC 400 probe controller.

Program step

Message (display)

Probe: Measure
Probe: Service

Rinse water

Cleaning agent
(Pump III)

Purge air

HOLD

DCS (terminal 32)
(Program running)

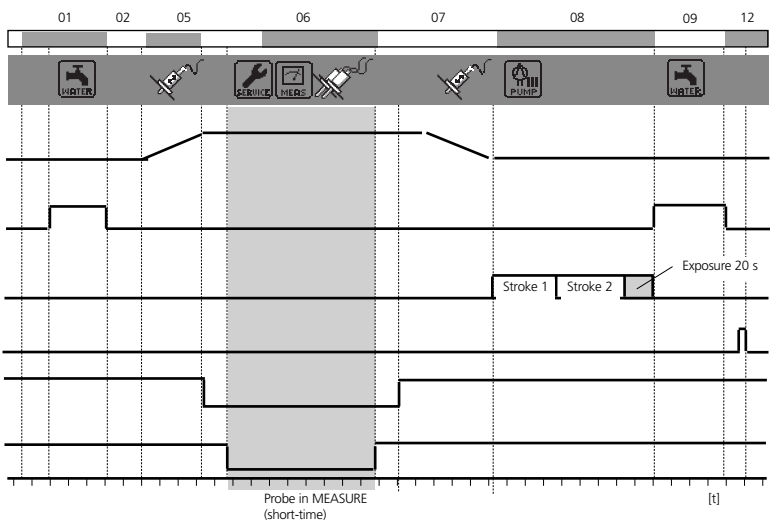

Parameter Setting: Program Flows

Cal 2point, Short-time, Media monitoring off

Display text	Time [s]
01: Rinse water ON	0010 s
02: Rinse water OFF	0002 s
03: Purge air ON*	0010 s
04: Purge air OFF*	0002 s
05: Buffer 7.00	0000 s allows programming a calibration delay
06: Cal Buffer 1	
07: Rinse water ON	0010 s
08: Rinse water OFF	0002 s
09: Purge air ON*	0010 s
10: Purge air OFF*	0002 s
11: Buffer 4.01	0000 s allows programming a calibration delay
12: Cal Buffer 2	
13: Rinse water ON	0010 s
14: Rinse water OFF	0002 s
15: Purge air ON*	0010 s
16: Purge air OFF*	0002 s
17: Program end	

Cal 2point (short-time) can also be started via a DCS input signal at input BIN2 of the EC 400 probe controller.

Program step

Message (display)

Probe: Measure

Probe: Service

Rinse water

Buffer 7.00

(Pump I)

Buffer 4.01

(Pump II)

Purge air

HOLD

DCS (terminal 32)

(Program running)

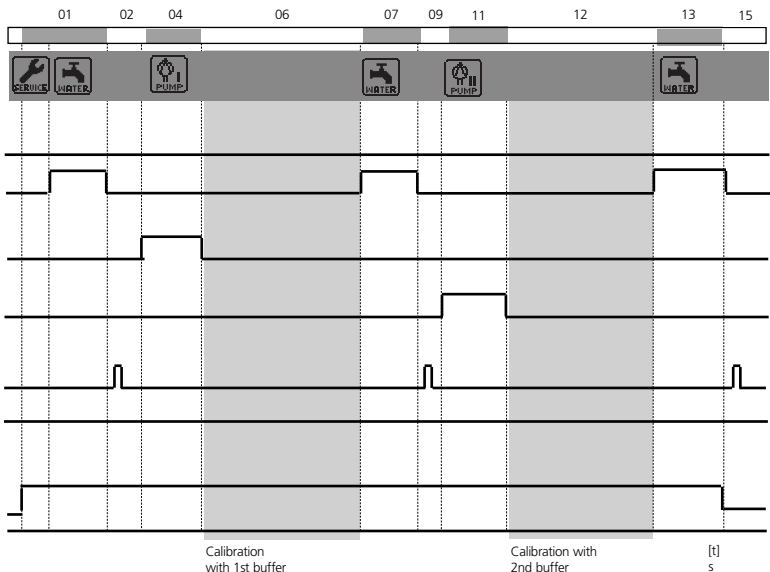

Parameter Setting: Program Flows

Cal 1point, Short-time, Media monitoring off

Display text	Time [s]
01: Rinse water ON	0010 s
02: Rinse water OFF	0002 s
03: Purge air ON*	0010 s
04: Purge air OFF*	0002 s
05: Buffer 7.00	0000 s <small>allows programming a calibration delay</small>
06: Cal Buffer 1	
07: Rinse water ON	0010 s
08: Rinse water OFF	0002 s
09: Purge air ON*	0010 s
10: Purge air OFF*	0002 s
11: Program end	

*: Text can be edited

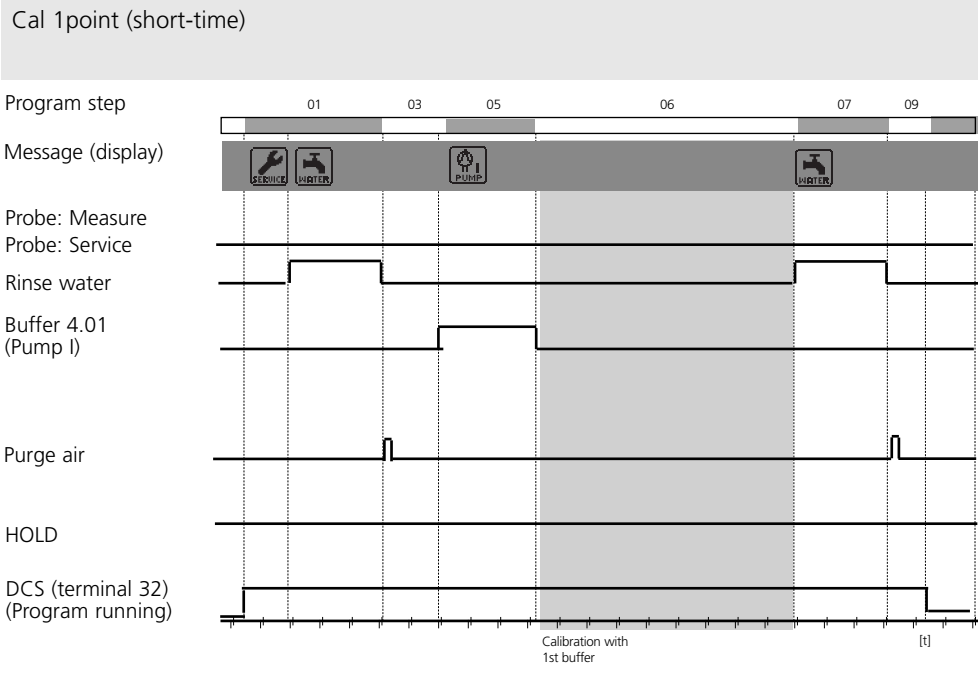

Parameter Setting: Program Flows

Service

Display text	Time [s]	
01: Probe in SERVICE		
02: Cleaner	0020 s	Measure -> Service
03: Rinse water ON	0060 s	
04: Rinse water OFF	0002 s	
05: Purge air ON	0010 s	
06: Purge air OFF	0002 s	
07: Wait position		Service position:
08: Rinse water ON	0010 s	
09: Rinse water OFF	0002 s	
10: Purge air ON	0010 s	
11: Purge air OFF	0002 s	
12: Probe in MEASURE	0005 s	Service -> Measuring This line allows programming an extended HOLD period
13: Program end		

*: Text can be edited

Service can also be started via a DCS input signal at input M/S of the EC 400 probe controller.

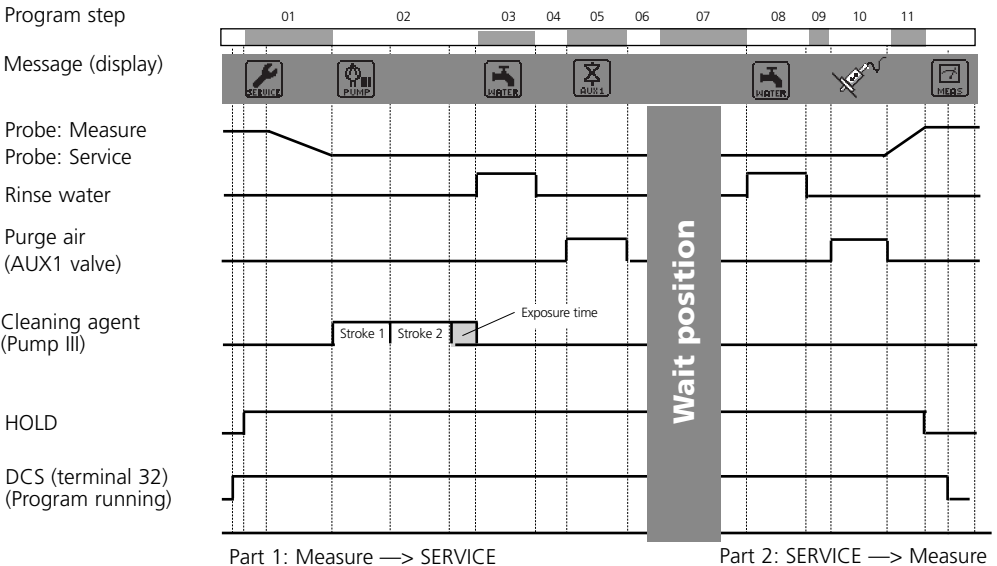

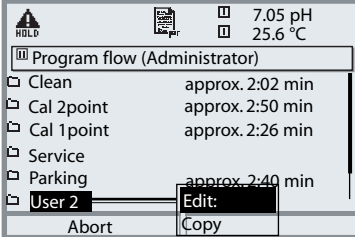
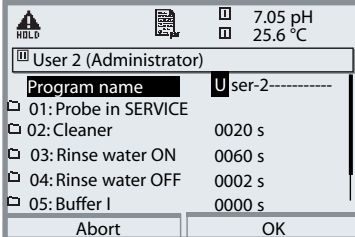
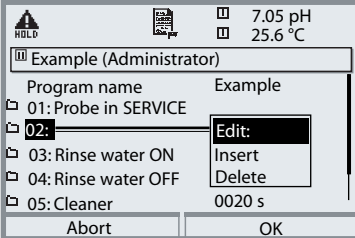
Menu	Display	Parameter setting Program flow
	 <p>7.05 pH 25.6 °C</p> <p>Program flow (Administrator)</p> <ul style="list-style-type: none"> ▢ Clean approx. 2:02 min ▢ Cal 2point approx. 2:50 min ▢ Cal 1point approx. 2:26 min ▢ Service ▢ Parking approx. 2:40 min ▢ User 2 Edit: <p>Abort Copy</p>	<p>Configure program flow</p> <p>Parameter setting / Probe control / Program flow / User 2: Select “Edit” using arrow keys, confirm with enter</p>
	 <p>7.05 pH 25.6 °C</p> <p>User 2 (Administrator)</p> <p>Program name U ser-2-----</p> <ul style="list-style-type: none"> ▢ 01: Probe in SERVICE ▢ 02: Cleaner 0020 s ▢ 03: Rinse water ON 0060 s ▢ 04: Rinse water OFF 0002 s ▢ 05: Buffer I 0000 s <p>Abort OK</p>	<p>Enter program name</p> <p>A new program name can be entered using the arrow keys. Confirm the name with enter</p>
	 <p>7.05 pH 25.6 °C</p> <p>Example (Administrator)</p> <p>Program name Example</p> <ul style="list-style-type: none"> ▢ 01: Probe in SERVICE ▢ 02: Edit: ▢ 03: Rinse water ON Insert ▢ 04: Rinse water OFF Delete ▢ 05: Cleaner 0020 s <p>Abort OK</p>	<p>Edit program step</p> <p>Select the program step you want to edit using the arrow keys. Press enter: Now you can choose between “Edit, Insert, Delete”.</p>
	<p style="text-align: center;">.</p>	<ul style="list-style-type: none"> • Edit: Allows selecting a function • Insert: Inserts an empty step above the selected program step and then allows selecting a function by “editing” empty step. • Delete: The program step is deleted.

Menu	Display	<ul style="list-style-type: none"> • Configure function • Activate monitoring
------	---------	---

par

7.05 pH
25.6 °C

Program flow (Administrator)

Function	<ul style="list-style-type: none"> Cal Buffer 1 Cal Buffer 2 Purge air On Purge air Off Aux medium On Aux medium Off <li style="background-color: #cccccc;">Blank step
----------	---

Abort
OK

For valve functions the run time must be specified, for pumps the exposure time.

Configure function
 Select a function using arrow keys, confirm with **enter**

- **Functions:**
 - Program end
 - Probe in SERVICE
 - Probe in MEASURE
 - Rinse water On
 - Rinse water Off
 - Wait time
 - Buffer I - - - Text can be edited during installation
 - Buffer II - - - Text can be edited during installation
 - Cleaning agent - - Text can be edited during install.
 - Cal Buffer 1
 - Cal Buffer 2
 - Purge air On - Text can be edited during installation
 - Purge air Off - Text can be edited during installation
 - Aux medium On - Text can be edited during install.
 - Aux medium Off - Text can be edited during install.
 - Goto - - - Jump to program line
 - ORP check

par

7.05 pH
25.6 °C

Example (Administrator)

Function	Cleaner On
Run-time	0020 s
Monitoring	On Off

Return

par

7.05 pH
25.6 °C

Example (Administrator)

Program name	Example 1
01: Probe in SERVICE	
02: Cleaner	0020 s Chk
03: Rinse water ON	0060 s
04: Rinse water OFF	0002 s
05: Pump	0000 s

Return

par

7.05 pH
25.6 °C

Media adapter (Administrator)

Port III	▼ Cleaning valve
Medium	Cleaner
Monitoring	▼ Process value
Setpoint	09.20 pH
Adm. deviation	01.00 pH

Return

Activate monitoring
 (see "Media monitoring")

With several functions you can monitor the media used in the calibration chamber ("Monitoring: On"). (e.g. cleaning agent, buffers, rinsing water, ...)

The respective program step is then marked with "Chk".

In any case it is necessary that you select the monitoring function for the respective medium in the "Installation" menu and specify valid tolerance limits for temperature or process value, otherwise the respective line is not displayed.

72

Parameter Setting: Installation

Configuration of EC 400 Functions

Installation	Default setting	Adjustable parameters
<ul style="list-style-type: none"> Measurement procedures 	Continuous	(Short-time)
<ul style="list-style-type: none"> Ext. control (DCS) <ul style="list-style-type: none"> - Signal level of inputs DCS (36 ... 39) M/S (42, 43) A/M (40, 41) - DCS output (34) - Signal level of outputs DCS (31 ... 34) 	Active: 10 ... 30 V	(Polarity / Output settings) (Active: 10 ... 30 V / active < 2V)
<ul style="list-style-type: none"> Sensor detection 	Measure	Alarm
<ul style="list-style-type: none"> Access manual control 	N/O	(N/O / N/C)
<ul style="list-style-type: none"> Probe <ul style="list-style-type: none"> - Max. move time - Sealing water - Wear counter Rinse water <ul style="list-style-type: none"> - Monitoring - Setpoint - Adm. deviation Media adapter <ul style="list-style-type: none"> - Port I ... III - Medium: - Displaced volume - Residual volume - Monitoring - Setpoint - Adm. deviation Additional media <ul style="list-style-type: none"> - Additional medium 1 - Additional medium 2 Start up 	Off	On
<ul style="list-style-type: none"> Access manual control 	Access code for manual control (Maintenance menu) Default: 2958	
<ul style="list-style-type: none"> Probe <ul style="list-style-type: none"> - Max. move time - Sealing water - Wear counter Rinse water <ul style="list-style-type: none"> - Monitoring - Setpoint - Adm. deviation Media adapter <ul style="list-style-type: none"> - Port I ... III - Medium: - Displaced volume - Residual volume - Monitoring - Setpoint - Adm. deviation Additional media <ul style="list-style-type: none"> - Additional medium 1 - Additional medium 2 Start up 	0015 s Off 0000	(On) (max.9999)
<ul style="list-style-type: none"> Rinse water <ul style="list-style-type: none"> - Monitoring - Setpoint - Adm. deviation Media adapter <ul style="list-style-type: none"> - Port I ... III - Medium: - Displaced volume - Residual volume - Monitoring - Setpoint - Adm. deviation Additional media <ul style="list-style-type: none"> - Additional medium 1 - Additional medium 2 Start up 	Off +07.00 pH 01.00 pH	(Process value/Temperature)
<ul style="list-style-type: none"> Media adapter <ul style="list-style-type: none"> - Port I ... III - Medium: - Displaced volume - Residual volume - Monitoring - Setpoint - Adm. deviation Additional media <ul style="list-style-type: none"> - Additional medium 1 - Additional medium 2 Start up 	Off* --- 50 mL 250 mL Off 07.00 pH 0.50 pH	"Pump" or "Off" (e.g. "Buffer I") Recommended displacement: InTrac 77Xe: 50 mL, InTrac 797e: 75 mL, InTrac 798e: 100 mL (0 / 250 / 500 mL) (Process value/Temperature) (Process medium or temp)
<ul style="list-style-type: none"> Additional media <ul style="list-style-type: none"> - Additional medium 1 - Additional medium 2 Start up 	Purge Air Off	(On - with monitoring) (On - with monitoring)
<ul style="list-style-type: none"> Start up 	No	Yes/No

*Automatic adjustment by "Plug & Play" in: System control / Factory setting EC 400

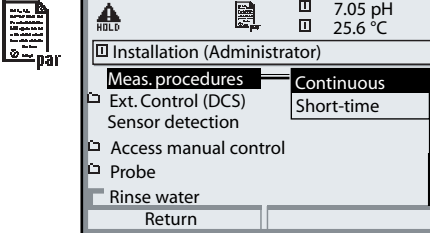
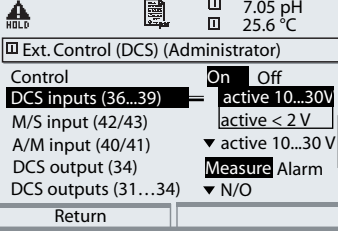
Menu	Display	<ul style="list-style-type: none"> • Meas. procedure • External control via DCS
	<ul style="list-style-type: none"> • Select measurement procedure <ul style="list-style-type: none"> • Continuous measurement: With continuous measurement the pH electrode is located in the process medium and is retracted for calibration or cleaning. • Short-time measurement: (interval measurement, sampling, sample mode ...) The pH electrode is only momentarily moved into the process medium. This method is applied when measuring aggressive or thermally demanding process media which require short measurement times with long rest periods. 	
		<ul style="list-style-type: none"> • External control via DCS <ul style="list-style-type: none"> • DCS inputs: Inputs for selecting the control programs. Here, the active signal level is specified. (< 2 V or 10 ... 30 V). • M/S input: Control of probe movement • A/M input: Intervals automatic / blocked • DCS output (34): Specifying the output signal for terminal 34: <ul style="list-style-type: none"> - Measuring or - Alarm • DCS outputs (31 ... 34): Specifying the contact type (N/O, N/C)

Control via Process Control System (DCS)

Inputs/Outputs EC 400(X)

No.	Designation	I / O	Level	Function
42	Measuring/ Service	E	0	Probe moves to measure position *
43			1	Probe moves to service position
40	Auto / Manual	E	0	Automatic interval control from M 700 *
41			1	automat. Lock intervals
37	Bin 3	E		Program selection and start, manual / DCS * **
38	Bin 2			(Program 1 ... 6 - see next page)
39	Bin 1			
34	Measuring*** (user-defined: "Alarm")	A	0	
			1	Probe in "MEASURE" position *
33	Service	A	0	
			1	Probe in "SERVICE" position *
32	Program runs	A	0	
			1	Program running *

* Passive contacts,
24 V must be supplied externally or via DCS

** Signal duration at least 2 s (passing contacts)

*** As delivered, the signal output DCS 34 serves for probe position feedback – as shown. However, you can also program this output as "Alarm". Then it sends a signal to the DCS in the event of calibration errors or faulty probe movement.

Control Programs and Measurement Procedures

Factory Settings

Control Programs for EC 400(X)

6 programs and one service program can be called up. 5 program flows are preset. 2 further programs can be entered by the user (User 1, User 2).

The programs are called up ...

- for manual operation via M 700(X)
- remotely via DCS or switch with passive inputs Bin 1 ... 3
(24 V must be externally supplied, see Specifications)

Program	Description	Bin 3	Bin 2	Bin 1
1	Cleaning	0	0	1
2	Two-point calibration (Cal 2point)	0	1	0
3	One-point calibration (Cal 1point)	0	1	1
4	Park position	1	0	0
5	User-programmable (User 1)	1	0	1
6	User-programmable (User 2)	1	1	0
7	Service program	Request via M/S		

The service program (7) stops all other running programs (1 - 6) immediately and erases stored requests. For programs 1-6 the following applies:

When you start a new program, the remaining steps of a currently running program are executed first. Further requests are stored and executed subsequently. When you control the EC 400(X) via M 700(X), you can block the Bin 1, Bin 2, Bin 3 signal lines as well as M/S and A/M to prevent conflicts (Parameter setting / Probe control / Installation / Ext. control (DCS): Off)

Measurement procedures

- Continuous measurement:
After cleaning / calibration the probe moves into the process for measurement
- Short-time measurement (interval measurement, sampling, sample mode ...)
After cleaning / calibration the probe remains in the calibration chamber and only moves into the process for measurement upon request.

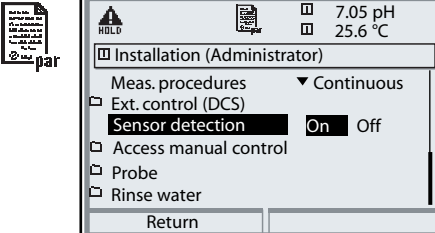
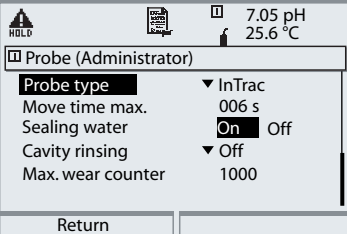
Menu	Display	<ul style="list-style-type: none"> • Sensor detection • Probe
	<p>Sensor detection</p> <p>Sensor detection “On” prevents accidental probe movement when the electrode has been removed. This is done by checking whether the temperature detector integrated in the sensor is connected.</p>	
	<p>Probe</p> <p>Selecting the retractable probe. Here, the max. move time is automatically adjusted (depending on model).</p> <p>Sealing water:</p> <p>Sealing water is switched on shortly before the probe movement is started to keep the rinsing chamber free from medium. This is important for processes containing fibrous or adhering media. The sealing water pressure must be higher than the medium pressure. Intrusion of medium is prevented by the counter-pressure in the rinsing chamber which is caused by the sealing water.</p> <p>Wear counter:</p> <p>Permits specifying the max. admissible number of move cycles until a message is generated.</p>	

Configuring Media Monitoring

Parameter setting / Probe control / Installation

Media Monitoring

For perfect system control, the pH value (or temperature) of the media used (buffer solutions, cleaning solution, rinsing water ...) can be checked against a specified value in the calibration chamber. This ensures that only correct media are used in the calibration chamber of the probe. Exchanged or contaminated media or media with a wrong temperature are recognized. In that case a message will be released. If faulty media are recognized before a calibration step, that step will not be performed.

Caution!

When monitoring the pH value of a medium, the zero and slope deviations of the electrode must be taken into account. Therefore the value specified for "adm. deviation" should not be too low!

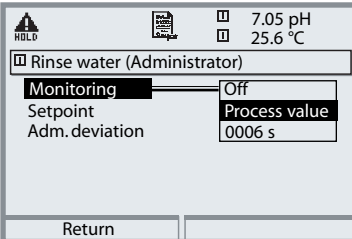
Menu	Display	Media monitoring media monitoring
 par		<p>Media monitoring can be configured in the "Parameter setting / Probe control / Installation" menu for:</p> <ul style="list-style-type: none">• Rinse water:• Media at media adapter (... in the "Media adapter" menu)• Additional media: The process value or temperature of the media can be monitored. Be sure to specify a sufficiently large "adm. deviation". The minimum response time is automatically taken into account when configuring the user programs.

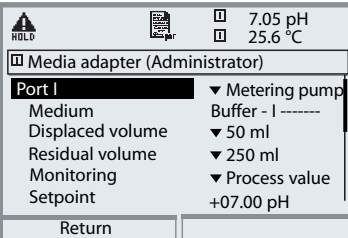
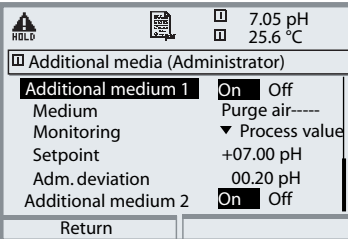
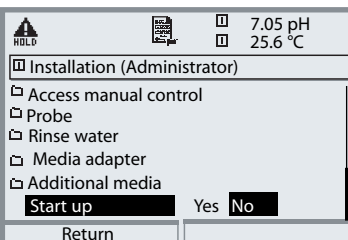
Menu	Display	• Media adapter, Additional media
	 <p> <input type="checkbox"/> Media adapter (Administrator) Port 1 ▼ Metering pump Medium Buffer - I ----- Displaced volume ▼ 50 ml Residual volume ▼ 250 ml Monitoring ▼ Process value Setpoint +07.00 pH Return </p>	<p>Media Adapter</p> <ul style="list-style-type: none"> • Specifying the equipment (Metering pump, Off, or Cleaning agent) • Designation of medium, • Specifying the displaced volume depending on model, e.g.: InTrac 77Xe 50 mL InTrac 797e 75 mL InTrac 798e 100 ml) • Residual volume • Monitoring (Process value/Temp) • Setpoint
	 <p> <input type="checkbox"/> Additional media (Administrator) Additional medium 1 On Off Medium Purge air----- Monitoring ▼ Process value Setpoint +07.00 pH Adm. deviation 00.20 pH Additional medium 2 On Off Return </p>	<p>Additional media (2)</p> <ul style="list-style-type: none"> • Specifying the equipment (On, Off) • Designation of medium, • Monitoring (Process value/Temp) • Setpoint
	 <p> <input type="checkbox"/> Installation (Administrator) <input type="checkbox"/> Access manual control <input type="checkbox"/> Probe <input type="checkbox"/> Rinse water <input type="checkbox"/> Media adapter <input type="checkbox"/> Additional media Start up Yes No Return </p>	<p>Start-Up</p> <p>At the end of the parameter-setting procedure, a "Start-up" line appears in the "Installation" menu. When you are sure to have set all parameters, select "Yes" to confirm. Now the pumps perform the number of stroke movements required for filling the media tubes completely. The necessary rinsing cycles are automatically started.</p>

Calibration / Adjustment

Note: HOLD mode active

Current outputs and relay contacts behave as configured

- **Calibration:** Detecting deviations without readjustment
- **Adjustment:** Detecting deviations with readjustment

Caution:

Without adjustment every pH meter delivers an imprecise or wrong output value! Every pH electrode has its individual zero point and its individual slope. Both values are altered by aging and wear.

To determine the correct pH value, the pH meter must be adjusted to the electrode. The analyzer corrects the voltage delivered by the electrode with regard to electrode zero and slope and displays it as the pH value.

Be sure to perform an adjustment after having replaced the electrode!

Procedure

First, a calibration is performed to detect the deviations of the electrode (zero, slope). To do so, the electrode is immersed in buffer solutions whose pH value is exactly known. The measuring module measures the electrode voltages and the buffer solution temperature and automatically calculates the electrode zero and slope. These data are stored in a calibration record. By "Adjustment" the determined calibration data can be used for correction (see following page).

The parameter determined by calibration

Zero is the pH value at which the pH electrode outputs the voltage 0 mV. It is different for each electrode and changes with age and wear.

Temperature of the process solution must be detected since pH measurement is temperature-dependent. Many electrodes have an integrated temperature probe.

Slope of an electrode is the voltage change per pH unit. For an ideal pH electrode, it lies at -59.2 mV/pH.

Adjustment

Adjustment means that the values determined by a calibration are taken over. The values determined for zero and slope are entered in the calibration record. (Cal record can be called up in the Diagnostics menu for the EC 700 module). These values are only effective for calculating the measured variables when the calibration has been terminated with an adjustment. A passcode ensures that an adjustment can only be performed by an authorized person (Administrator). The Operator can check the current sensor data by a calibration and inform the Administrator when there are deviations. You can use the additional function SW 700-107 for granting access rights (passcodes) and for AuditTrail (continuous data recording and backup according to FDA 21 CFR Part 11).

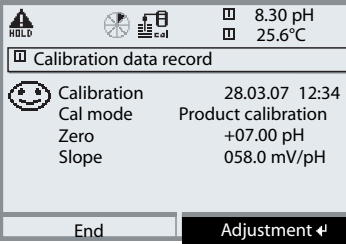
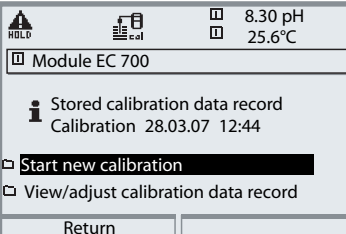
Menu	Display	Adjustment after calibration
		<p>Administrator</p> <p>With the corresponding access rights, the device can immediately be adjusted after calibration. The calibration values are taken over for calculating the measured variables.</p>
		<p>Operator (without administrator rights)</p> <p>After calibration, change to measuring mode. Inform Administrator. When opening the menu (Calibration, respective module), the Administrator sees all data of the last calibration and can take over the values or perform a new calibration.</p>

Calibration / Adjustment

Calibration Methods

One-Point Calibration

The electrode is calibrated with one buffer solution only.

Here, only the electrode zero point is detected and taken into account by the M 700. One-point calibration is appropriate and permissible whenever the measured values lie near the electrode zero point so that slope changes do not have much of an impact.

Two-Point Calibration

The electrode is calibrated with two buffer solutions.

In that case, zero point and slope of the electrode can be detected and taken into account by the M 700. Two-point calibration is required if

- the electrode has been replaced
- the measured pH values cover a wide range
- there is great difference between the measured pH value and the electrode zero
- the pH measurement must be very accurate,
- the electrode is exposed to extreme wear.

Three-Point Calibration

The electrode is calibrated with three buffer solutions.

Zero and slope are calculated using a line of best fit according to DIN 19268.

Sensor Replacement - First Calibration

A First Calibration must be performed each time the electrode is replaced.

During First Calibration, the electrode data together with the electrode type and serial number are stored as reference values for electrode statistics.

The "Statistics" menu of Diagnostics shows the deviations of zero, slope, glass and reference electrode impedance, and response time of the last three calibrations with respect to the reference values of the First Calibration.

This allows evaluation of the drift behavior and aging of the electrode.

Calibration / Adjustment

Temperature Compensation

Temperature Compensation During Calibration

There are two important reasons for determining the temperature of the buffer solution:

The slope of the pH electrode is temperature-dependent. Therefore the measured voltage must be corrected by the temperature influence.

The pH value of the buffer solution is temperature-dependent. For calibration, the buffer solution temperature must therefore be known in order to choose the actual pH value from the buffer table.

During parameter setting you define whether cal temperature is measured automatically or must be entered manually:

Automatic Temperature Compensation

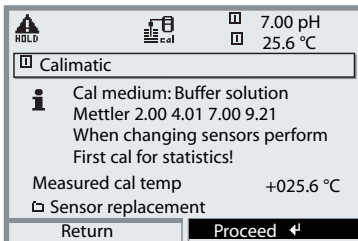

For automatic cal temp detection, the M 700 measures the temperature of the buffer solution with a temperature probe. (Pt 100/Pt 1000/ NTC 30 k Ω /NTC 8.55 k Ω). If you work with automatic temperature compensation during calibration, a temperature probe connected to the temperature input of the M 700 must be in the buffer solution!

Otherwise, you must select manual entry of calibration temperature.

Manual Temperature Compensation

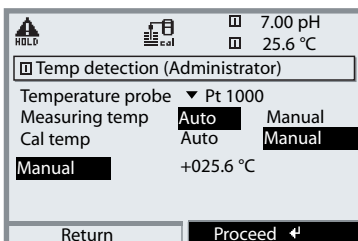

The temperature of the buffer solution must be entered manually in the Parameter setting menu at "Parameter setting / <pH module> / Sensor data / Temp detection / Cal temp -> manual". Temperature measurement is performed using a glass thermometer, for example.

Automatic Calibration

Probe Control

Calibration Procedures



The EC 400 probe controller allows automatic execution of calibrations either at fixed intervals or time-controlled according to a week program. The week program is defined in the “Parameter setting” menu. It can automatically start up to 10 programs flows for each weekday.

Program Flows for One- and Two-Point Calibration

The program flows for one- and two-point calibrations are preset but can be modified in the “Parameter setting” menu.

Probe Controller: Start Programs

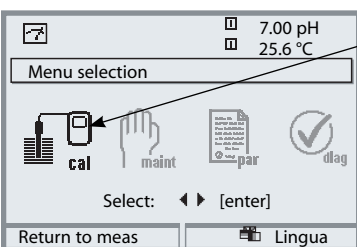
The programs can be started directly from the “Calibration” menu.

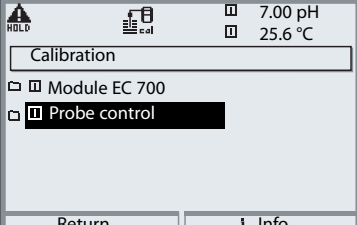
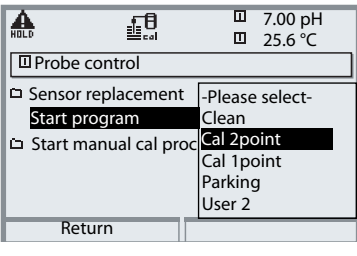
Menu	Display	Probe control - Start program
		<p>Call up calibration</p> <p>Press menu key to select menu. Select calibration using arrow keys, confirm with enter, passcode 1147 (To change passcode, select: Parameter setting / System control / Passcode entry)</p>
		<p>After passcode entry, the system is in HOLD mode: Current outputs and relay contacts behave as configured (BASE) until the Calibration menu is exited.</p> <p>Select "Probe control".</p>
		<p>"Start program" opens a pull-down menu with different programs which have been defined in the "Parameter setting" menu.</p>

Manual Electrode Calibration

Probe Control



Manual electrode calibration (zero, slope) must be performed with the electrode removed. For that purpose, the sensor lock-gate automatically moves into SERVICE position when the calibration menu is called up. Electrode located in the process medium.



Warning!

Before working on the sensor lock-gate, it must be moved into SERVICE position. Be sure to read and observe the instruction manual of your retractable probe!

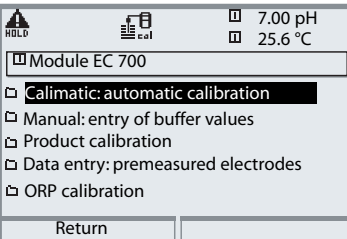
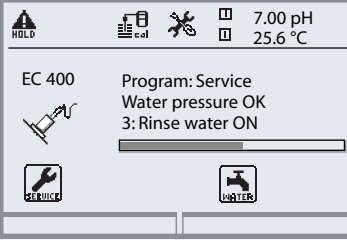
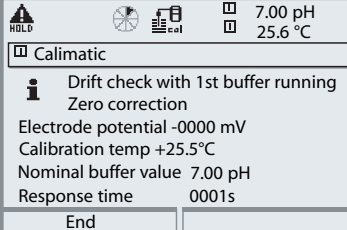
Menu	Display	Start manual Cal proc
		<p>Call up calibration Press menu key to select menu. Select calibration using arrow keys, confirm with enter, passcode 1147 (To change passcode, select: Parameter setting / System control / Passcode entry)</p>
		<p>After passcode entry, the system is in HOLD mode: Current outputs and relay contacts behave as configured (BASE) until the Calibration menu is exited. Select "Probe control".</p>
		<p>Pressing enter at "Start manual cal process" allows the selection of a calibration method.</p>

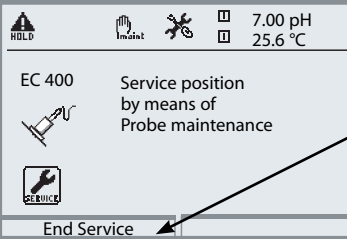
Menu	Display	Probe in SERVICE position
	 <p>Module EC 700</p> <ul style="list-style-type: none"> Calimatic: automatic calibration Manual: entry of buffer values Product calibration Data entry: premeasured electrodes ORP calibration <p>Return</p>	<p>Select calibration method: (For descriptions see Pg 90 et seq.) When you open the Calibration menu, the M 700 automatically proposes the previous calibration method. (If you do not want to calibrate, press the "Return" softkey or the meas key.)</p>
	 <p>EC 400</p> <p>Program: Service Water pressure OK 3: Rinse water ON</p> <p>SERVICE WATER</p>	<p>Probe in SERVICE position When the "SERVICE" program is executed, the probe is moved into SERVICE position. The program steps are indicated in the display.</p>
	 <p>Calimatic</p> <p>Drift check with 1st buffer running Zero correction</p> <p>Electrode potential -0000 mV Calibration temp +25.5°C Nominal buffer value 7.00 pH Response time 0001s</p> <p>End</p>	<p>Remove electrode Make sure that the probe is in SERVICE position. Then proceed as described in the instruction manual of the retractable probe.</p> <p>Start calibration Follow the instructions given in the display. After end of calibration reinstall the electrode.</p>
	 <p>EC 400</p> <p>Service position by means of Probe maintenance</p> <p>SERVICE</p> <p>End Service</p>	<p>End calibration Open the Maintenance menu (Probe control / Probe maintenance). After having terminated the servicing work, press the "End Service" softkey to move the probe back to "Measuring" position (PROCESS).</p>

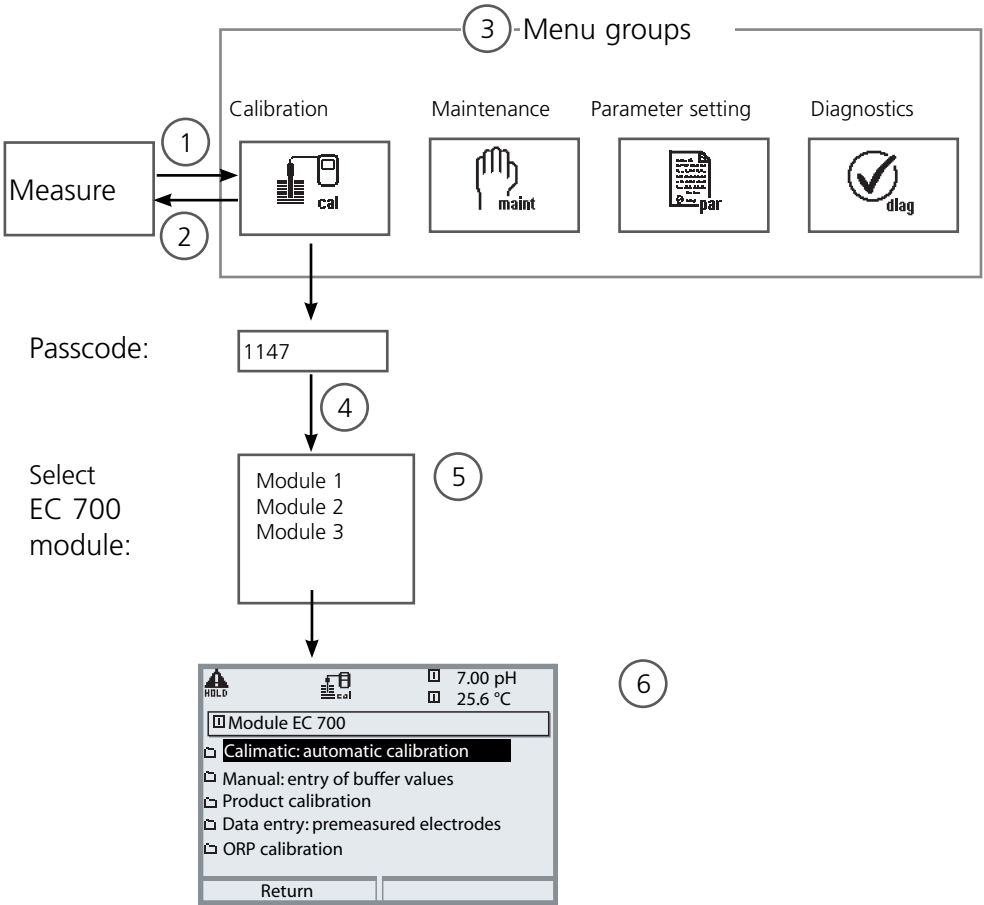

Calibration / Adjustment

Select a calibration method

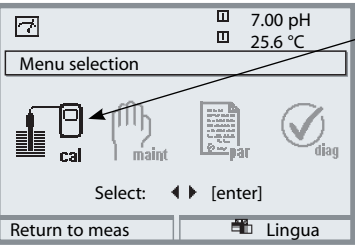

Calibration of EC 700 module: Select a calibration method

- (1) Press **menu** key to access menu selection
- (2) Pressing the **meas** key returns to measurement
- (3) Select Calibration menu group using the arrow keys
- (4) Press **enter** to confirm, enter passcode
- (5) Select pH module, confirm with **enter**.
- (6) Select calibration method

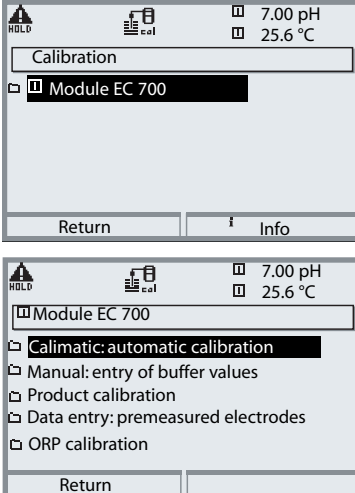
Menu	Display	Select calibration method (pH)
		<p>Call up calibration</p> <p>Press menu key to select menu. Select calibration using arrow keys, confirm with enter, passcode 1147 (To change passcode, select: Parameter setting / System control / Passcode entry)</p> <p>After passcode entry, the system is in function check mode: Current outputs and relay contacts behave as configured (Module BASE) until the Calibration menu is exited.</p>
		<p>Calibration: Select "Module EC 700"</p> <p>Select calibration method:</p> <ul style="list-style-type: none"> • Automatic buffer recognition • Manual entry of buffer values • Product calibration (Calibration with sampling) • Entry of previously measured calibration data • ORP calibration/adjustment • ISFET zero adjustment <p>When you open the Calibration menu, the analyzer automatically proposes the previous calibration method.</p> <p>If you do not want to calibrate, press the "Return" softkey or the meas key.</p>

Calibration / Adjustment

Calimatic Automatic Buffer Recognition

Automatic Buffer Recognition (Calimatic)

Automatic calibration using Calimatic is performed with one, two, or three buffer solutions. M 700 automatically detects the nominal buffer value on the basis of the electrode potential and the measured temperature. Any sequence of buffer solutions is possible, but they must belong to the buffer set defined during parameter setting.

The Calimatic takes the temperature dependence of the buffer value into account. All calibration data is converted using a reference temperature of 25 °C.



During calibration the analyzer is in HOLD mode.

Current outputs and relay contacts behave as configured (Module BASE).

Caution!

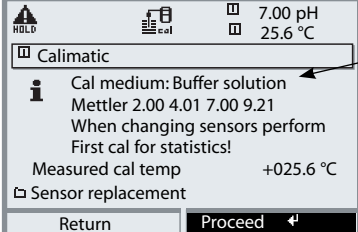
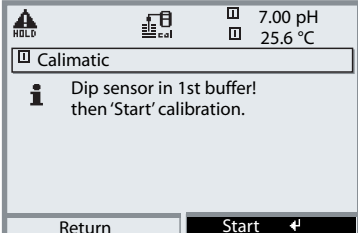
Only ever use fresh, undiluted buffer solutions which belong to the selected buffer set!

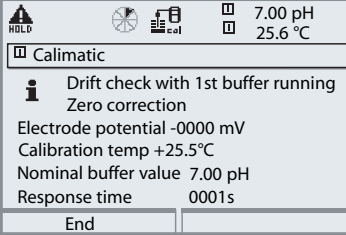
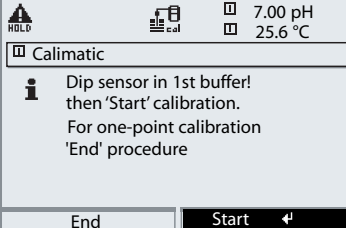
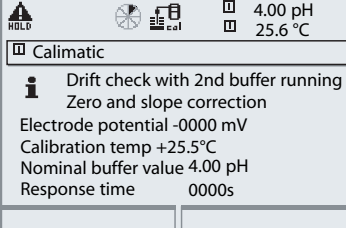
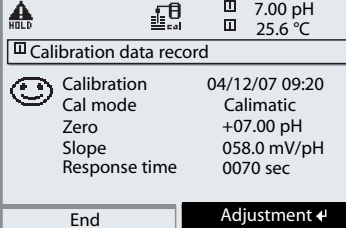
Menu	Display	Automatic buffer recognition
	 <p>The screenshot shows the Calimatic menu in HOLD mode. At the top, it displays '7.00 pH' and '25.6 °C'. Below that, 'Calimatic' is selected. An information icon (i) is followed by the text: 'Cal medium: Buffer solution', 'Mettler 2.00 4.01 7.00 9.21', 'When changing sensors perform First cal for statistics!', 'Measured cal temp +025.6 °C', and 'Sensor replacement'. At the bottom, there are 'Return' and 'Proceed' softkeys.</p>	Select: Calimatic <ul style="list-style-type: none">• Display of selected buffer set• Display of measured cal temp.• Select sensor replacement Proceed with softkey or enter
	 <p>The screenshot shows the Calimatic menu in HOLD mode. At the top, it displays '7.00 pH' and '25.6 °C'. Below that, 'Calimatic' is selected. An information icon (i) is followed by the text: 'Dip sensor in 1st buffer! then 'Start' calibration.'. At the bottom, there are 'Return' and 'Start' softkeys.</p>	Remove and rinse the electrode (Caution: Do not rub! Electrostatic hazard!), then immerse it in the first buffer solution. Start with softkey or enter

Menu	Display	Automatic buffer recognition
	 <p>Calimatic</p> <p>i Drift check with 1st buffer running Zero correction Electrode potential -0000 mV Calibration temp +25.5°C Nominal buffer value 7.00 pH Response time 0001s</p> <p>End</p>	<p>Display of nominal buffer value. You can press "End" to reduce the waiting time before stabilization of the electrode potential (reduced accuracy of calibration values). From the response time, you see how much time the electrode needs for the potential to stabilize. If the electrode potential or the measured temperature fluctuate greatly, the calibration procedure is aborted after 2 min.</p>
	 <p>Calimatic</p> <p>i Dip sensor in 1st buffer! then 'Start' calibration. For one-point calibration 'End' procedure</p> <p>End Start ↵</p>	<p>For a one-point calibration, press "End" softkey. For two-point calibration: Rinse electrode thoroughly! Immerse electrode in the second buffer solution. Start with softkey or enter</p>
	 <p>Calimatic</p> <p>i Drift check with 2nd buffer running Zero and slope correction Electrode potential -0000 mV Calibration temp +25.5°C Nominal buffer value 4.00 pH Response time 0000s</p>	<p>Calibration is performed with the second buffer.</p> <p>Three-point calibration is performed correspondingly with the third buffer.</p>
	 <p>Calibration data record</p> <p> Calibration 04/12/07 09:20 Cal mode Calimatic Zero +07.00 pH Slope 058.0 mV/pH Response time 0070 sec</p> <p>End Adjustment ↵</p>	<p>Adjustment Press "Adjust" to take over the values determined during calibration for calculating the measured variables.</p>

Calibration / Adjustment

Calibration with Manual Entry of Buffer Values

Calibration with Manual Entry of Buffer Values

Calibration with manual entry of buffer values is performed with one, two, or three buffer solutions.

M 700 displays the measured temperature.

You must then enter the temperature-corrected buffer values. To do so, refer to the buffer table (e.g. on the bottle) and enter the buffer value belonging to the displayed temperature.

Intermediate values must be interpolated.

All calibration data is converted using a reference temperature of 25 °C.









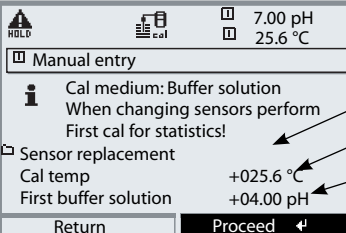
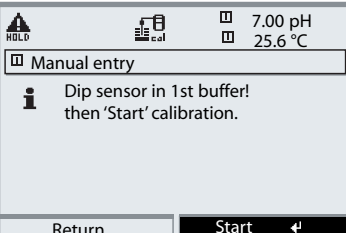

















During calibration the analyzer is in HOLD mode.

Current outputs and relay contacts behave as configured (Module BASE).

Caution!

Only ever use fresh, undiluted buffer solutions!

Menu	Display	Manual entry
		<p>Select: Manual entry</p> <p>Select: Sensor replacement Display: calibration temp Enter first buffer value Proceed with softkey or enter</p>
		<p>Remove and rinse the electrode (Caution: Do not rub! Electrostatic hazard!), then immerse it in the first buffer solution. Start with softkey or enter</p>

Menu	Display	Manual entry
  cal	     4.00 pH 25.6 °C Manual entry  Drift check with 1st buffer running. Zero correction Electrode potential -0224 mV Calibration temp +25.6°C Nominal buffer value +04.00 pH Response time 0018s End	<p>Calibration with first buffer solution. You can press “End” to reduce the waiting time before stabilization of the electrode potential (reduced accuracy of calibration values). From the response time, you see how much time the electrode needs for the potential to stabilize. If the electrode potential or the measured temperature fluctuate greatly, the calibration procedure is aborted after 2 min.</p>
	     7.00 pH 25.6 °C Manual entry  Dip sensor in 1st buffer! then ‘Start’ calibration. For one-point calibration ‘End’ procedure Second buffer solution +07.00 pH End Start ←	<p>One-point calibration: “End”. Two-point calibration: Rinse electrode thoroughly! Enter 2nd buffer value for correct temperature. Immerse electrode in the second buffer solution. Start with softkey or enter</p>
	     7.00 pH 25.6 °C Manual entry  Drift check with 2nd buffer running Zero and slope correction Electrode potential -0000 mV Calibration temp +25.6°C Nominal buffer value +07.00 pH Response time 0007s End	<p>Calibration is performed with the second buffer. Three-point calibration is performed correspondingly with the third buffer.</p>
	     7.00 pH 25.6 °C Calibration data record  Calibration 04/04/07 09:20 Cal mode Manual input Zero +07.00 pH Slope 058.0 mV/pH Response time 0070 sec End Adjustment ←	<p>Adjustment Press “Adjust” to take over the values determined during calibration for calculating the measured variables.</p>

Calibration / Adjustment

Product Calibration

Product Calibration (Calibration with sampling)

When the electrode cannot be removed – e.g. for sterility reasons – its zero point can be determined with “sampling”. To do so, the currently measured process value is stored by the M 700. Immediately afterwards, you take a sample from the process. The pH value of the sample is measured in the lab or directly on the site using a portable pH meter. The reference value is entered into the measuring system. From the difference between measured value and reference value, the M 700 calculates the electrode zero point (this method only allows one-point calibration).

During calibration the analyzer is in HOLD mode.

Current outputs and relay contacts behave as configured (Module BASE).

Caution! The pH value of the sample is temperature-dependent. Therefore, the reference measurement should be performed at the sample temperature shown in the display. Transport the sample in an insulated container. The pH value may also be altered due to escaping of volatile substances.

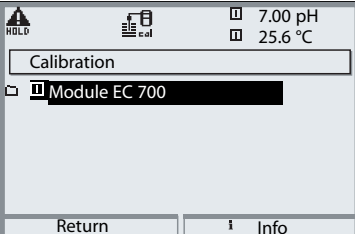
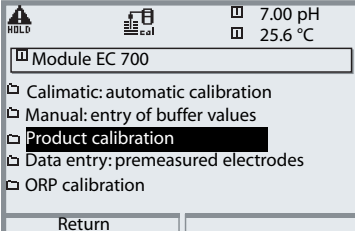
Menu	Display	Product calibration
		<p>Select module: EC 700</p> <p>The analyzer is in HOLD mode. Current outputs and relay contacts behave as configured (Module BASE). Confirm with enter.</p>
		<p>Select calibration mode “Product calibration”</p> <p>Confirm with enter.</p>

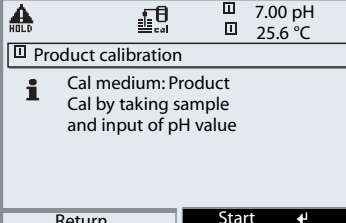
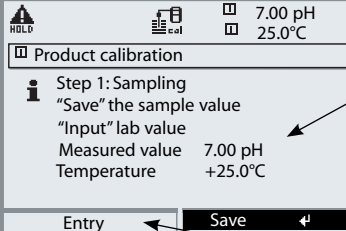
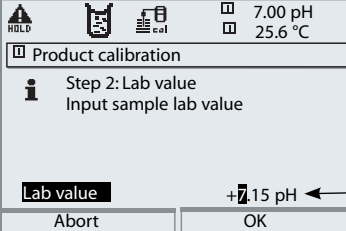
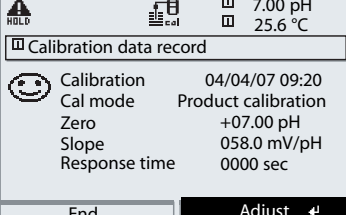
Menu	Display	Product calibration
	 <p>Product calibration</p> <p>Cal medium: Product Cal by taking sample and input of pH value</p> <p>Return Start</p>	<p>Product calibration</p> <p>Product calibration is performed in 2 steps. Prepare sampling, Start with softkey or enter.</p>
	 <p>Step 1: Sampling "Save" the sample value "Input" lab value</p> <p>Measured value 7.00 pH Temperature +25.0°C</p> <p>Entry Save</p>	<p>Step 1</p> <p>Take sample. Store measured value and temperature at the moment of sampling ("Save" softkey or enter) Press meas to return to measure- ment.</p> <p>Exception: Sample value can be measured on the site and be entered immediately. To do so, press "Input" softkey.</p>
	 <p>Step 2: Lab value Input sample lab value</p> <p>Lab value +7.15 pH</p> <p>Abort OK</p>	<p>Step 2</p> <p>Lab value has been measured. When you open the Product calibra- tion menu again, the display shown on the left appears: Enter reference value ("Lab value"). Confirm with OK or repeat calibration.</p>
	 <p>Calibration data record</p> <p>Calibration 04/04/07 09:20 Cal mode Product calibration Zero +07.00 pH Slope 058.0 mV/pH Response time 0000 sec</p> <p>End Adjust</p>	<p>Adjustment</p> <p>Press "Adjust" to take over the val- ues determined during calibration for calculating the measured variables.</p>

Calibration / Adjustment

Calibration by Entering Data from Premeasured Electrodes

Data Entry of Premeasured Electrodes

Entry of values for zero point, slope, and isothermal potential of a pH electrode. The values must be known, e.g. determined beforehand in the laboratory.

Caution! Input of an isothermal potential V_{iSO} also applies to the calibration methods

- Calimatic
- Manual input and
- product calibration.

For an explanation of the isothermal potential, refer to Pg 97.

During calibration the analyzer is in HOLD mode.

Current outputs and relay contacts behave as configured (Module BASE).

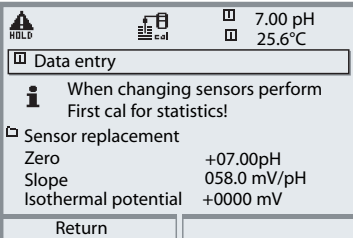
Menu	Display	Manual entry
		<p>Select: Data entry of premeasured electrodes</p> <p>Remove electrode and connect premeasured electrode. Call up "Sensor replacement". Enter the values for</p> <ul style="list-style-type: none"> • Zero • Slope • Isothermal potential <p>Return with softkey. Return to measurement with meas</p>

Isothermal Potential

The isothermal intersection point is the point of intersection between two calibration lines at two different temperatures. The potential difference between the electrode zero point and this intersection point is the isothermal potential "Viso".

It may cause measurement errors depending on the temperature. These errors can be compensated for by defining the "Viso" value.

- Measurement errors are avoided by calibrating at measuring temperature or at a controlled and stable temperature.

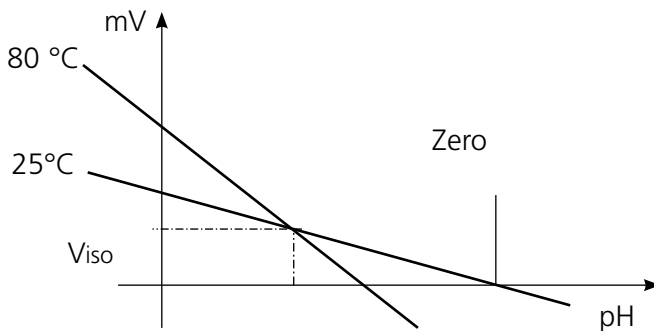

Monitoring Functions for Calibration

M 700 provides comprehensive functions for monitoring proper calibration performance and the electrode condition. This allows documentation for quality management to ISO 9000 and GLP/GMP.

- Sensocheck monitors the electrode condition by measuring the glass and reference electrode impedances.
- Regular calibration can be monitored by the cal timer.
- Adaptive cal timer - automatically reduces the calibration interval when the electrode is subjected to high stress
- The calibration record (GLP/GMP) provides all relevant data of the last calibration and adjustment.
- The statistics show the behavior of the electrode parameters during the last three calibrations compared to the First Calibration.
- The logbook shows the time and date of a performed calibration.

Calibration / Adjustment

ORP Calibration/Adjustment

ORP Calibration/Adjustment

The potential of a redox electrode is calibrated using a redox (ORP) buffer solution. In the course of that, the difference between the measured potential and the potential of the calibration solution is determined. This potential difference is printed on the calibration solution bottle and is defined as the voltage across the redox electrode and a reference electrode.

Examples: 220 mV Pt against Ag/AgCl, KCl 3 moles/l
 427 mV Pt against SHE

During measurement this difference is added to the measured potential.

$$mV_{\text{ORP}} = mV_{\text{meas}} + \Delta mV$$

mV_{ORP} = displayed oxidation-reduction potential (measured ORP)

mV_{meas} = direct electrode potential (ORP input, see Sensor monitor)

ΔmV = delta value, determined during calibration













ORP Related to the Standard Hydrogen Electrode (SHE)

The oxidation-reduction potential can also be calibrated automatically with respect to the standard hydrogen electrode (SHE). To do so, you must first select the reference electrode used (see Parameter setting).

The temperature behavior of the reference electrode is automatically taken into account.

You can choose from the following types of reference electrodes:

Ag/AgCl, KCl 1 mole/l	(Silver/silver chloride)
Ag/AgCl, KCl 3 moles/l	(Silver/silver chloride)
Hg, Ti/TiCl, KCl 3.3 moles/l	(Thalamid)
Hg/Hg ₂ SO ₄ , K ₂ SO ₄ saturated	(Mercury sulfite)

Menu	Display	ORP adjustment
 cal	   200 mV  25.6 °C ORP adjustment Reference electrode Ag/AgCl,KCl 1m Temperature +25.5°C ORP input +200 mV ORP setpoint +200 mV Return	<p>The type of reference electrode is selected during parameter setting. Immerse electrode in calibration medium and wait until the ORP value has stabilized. Enter the nominal ORP value (bottle).</p> <p>Be sure to observe the correct reference! (as configured) Confirm with "OK".</p>
	   200 mV  25.6 °C ORP adjustment Reference electrode Ag/AgCl,KCl 1m Temperature +25.5°C ORP input +200 mV ORP setpoint +220 mV Abort OK	
	   220 mV  25.6 °C ORP adjustment Reference electrode Ag/AgCl,KCl 1m Temperature +25.5°C ORP input +200 mV ORP setpoint +220 mV Return End	<p>End adjustment with softkey or enter</p>

Temperature dependence of commonly used reference systems measured against SHE

Temperature [°C]	Ag/AgCl/KCl 1 mole/l [ΔmV]	Ag/AgCl/KCl 3 moles/l [ΔmV]	Thalamid [ΔmV]	Mercury sulfate [ΔmV]
0	249	224	-559	672
10	244	217	-564	664
20	240	211	-569	655
25	236	207	-571	651
30	233	203	-574	647
40	227	196	-580	639
50	221	188	-585	631
60	214	180	-592	623
70	207	172	-598	613
80	200	163	-605	603

Calibration / Adjustment

ISFET Zero Adjustment

ISFET Zero Adjustment

Note:

The EC 700 module does not supply the power for operating the ISFET adapter.











When measuring with an ISFET sensor (e.g. InPro 3300), the nominal zero point must be adjusted each time a new sensor is connected (to adjust the operating point). The adjustment for that sensor remains stored in the analyzer.

Afterwards, you should perform a two-point calibration using one of the following methods:

- Calimatic: automatic calibration
- Manual entry of buffer values
- Data entry: premeasured electrodes

During calibration the analyzer is in HOLD mode.

Current outputs and relay contacts behave as configured (Module BASE).

Menu	Display	ISFET zero adjustment
 cal	  7.00 pH 25.6°C <hr/> ISFET zero adjustment <hr/>  Dip sensor in buffer solution! Enter temperature-corrected pH in the range pH 6.5...7.5 then "Start" calibration. Enter cal temp +025.6°C Buffer +07.00 pH <hr/> Return Start ←	<p>Immerse sensor in a zero point buffer (6.5 ... 7.5). Enter temperature-corrected pH value (see buffer table). Start zero adjustment.</p>
	  7.00 pH 25.6°C <hr/> ISFET zero adjustment <hr/>  Drift check running! Zero correction Electrode voltage 122 mV Calibration temperature 25.6 °C Nominal buffer value 7.00 pH Response time 10 s <hr/> End	<p>To abort, you can press the "End" softkey. However, this reduces adjustment accuracy. (Zero error of sensor up to max. ±200 mV possible)</p>
	  7.00 pH 25.6°C <hr/> Calibration data record <hr/>  Active adjustment 24.03.07 09:20 Cal mode ISFET zero ISFET zero +0122 mV Response time 0070 sec <hr/> End ←	<p>At the end of the adjustment procedure the ISFET zero (based on 25 °C) is displayed. This is not the real sensor value! The actual value must be determined afterwards by a complete two-point calibration.</p>

Maintenance of EC 700

Sensor monitor, Temp probe adjustment

Note: HOLD mode is active.

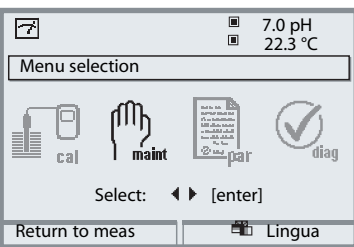
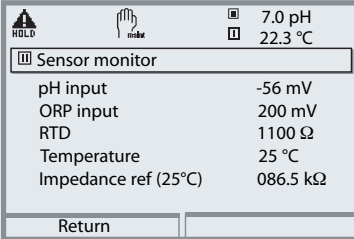
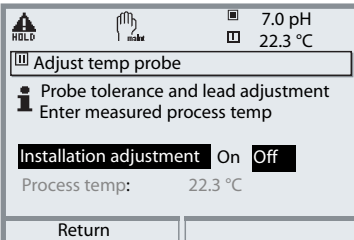
Menu	Display	Maintenance
	  	<p>Call up Maintenance From the measuring mode: Press menu key to select menu. Select Maintenance (maint) using arrow keys, confirm with enter. Passcode as delivered: 2958 Then select "Module EC 700".</p> <p>Sensor monitor for validation of sensor and complete measured-value processing.</p> <p>Temp probe adjustment This function allows you to compensated for the individual temperature probe tolerance and the influence of the lead resistances to increase accuracy of temperature measurement. Adjustment may only be carried out when the process temperature is precisely measured using a calibrated reference thermometer! The measurement error of the reference thermometer should be less than 0.1 °C. Adjustment without precise measurement might result in considerable deviations of the measured value display!</p>

Probe Maintenance via M 700(X)

“Maintenance / Probe control” Menu

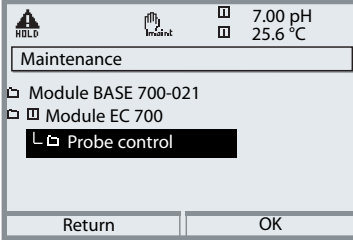
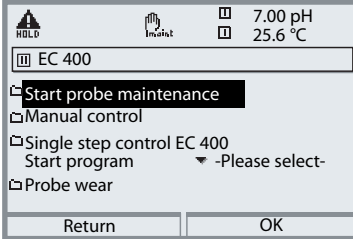
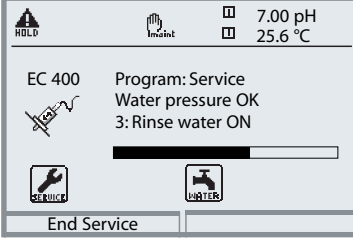
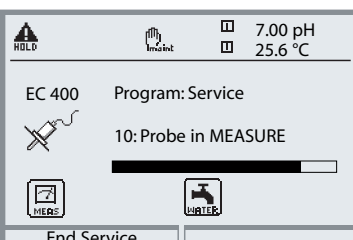
Menu	Display	Maintenance																						
	   	<p>Select “Probe control”.</p> <p>The maintenance menu shows the probe controller as a component of the EC 700 module. Select using arrow keys, confirm with enter</p> <p>Probe maintenance</p> <p>With the “SERVICE” program, the probe is moved into SERVICE position. The individual program steps are indicated in the display:</p> <table border="1" data-bbox="560 842 991 1209"> <tr><td>01: Probe in SERVICE</td><td></td></tr> <tr><td>02: Cleaning agent</td><td>0020 sec</td></tr> <tr><td>03: Rinse water ON</td><td>0060 sec</td></tr> <tr><td>04: Rinse water OFF</td><td>0002 sec</td></tr> <tr><td>05: Purge air ON</td><td>0005 sec</td></tr> <tr><td>06: Purge air OFF</td><td>0002 sec</td></tr> <tr><td>07: Wait position</td><td></td></tr> <tr><td>08: Rinse water ON</td><td>0010 sec</td></tr> <tr><td>09: Rinse water OFF</td><td>0002 sec</td></tr> <tr><td>10: Probe in MEASURE</td><td>0005 sec</td></tr> <tr><td>11: Program end</td><td></td></tr> </table> <p>After end of servicing work the probe moves back to “Measuring” position (PROCESS).</p>	01: Probe in SERVICE		02: Cleaning agent	0020 sec	03: Rinse water ON	0060 sec	04: Rinse water OFF	0002 sec	05: Purge air ON	0005 sec	06: Purge air OFF	0002 sec	07: Wait position		08: Rinse water ON	0010 sec	09: Rinse water OFF	0002 sec	10: Probe in MEASURE	0005 sec	11: Program end	
01: Probe in SERVICE																								
02: Cleaning agent	0020 sec																							
03: Rinse water ON	0060 sec																							
04: Rinse water OFF	0002 sec																							
05: Purge air ON	0005 sec																							
06: Purge air OFF	0002 sec																							
07: Wait position																								
08: Rinse water ON	0010 sec																							
09: Rinse water OFF	0002 sec																							
10: Probe in MEASURE	0005 sec																							
11: Program end																								

Manual Control via M 700(X)

“Maintenance / Probe control” Menu

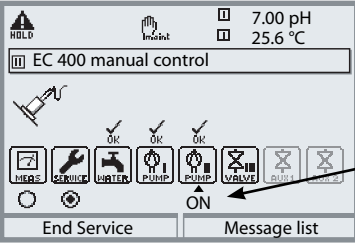
Menu	Display	Maintenance
		<p>Manual control (requires access code*) Select function using arrow keys. Symbol flashes, activate with enter – “On” appears below the icon. End with enter. (“ON” disappears again.)</p> <p>* The access code is specified in the “Parameter setting / Installation” menu. Default: 2958.</p>



Warning for Use of Manual Control!

Make sure that the probe is separated from the process!

Manual control via M 700(X) allows actuating the probe controller for servicing.

Rinsing water, media supply, and valve functions can be tested individually.

Single Step Control

“Maintenance / Probe control” Menu

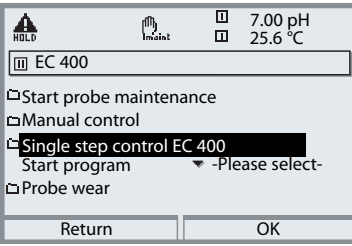
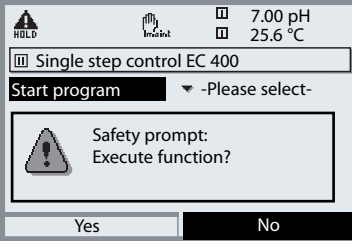
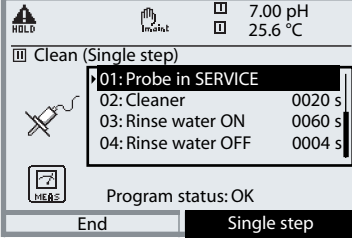
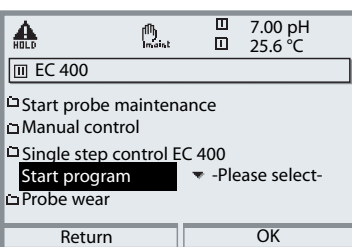
Menu	Display	Maintenance												
	   	<h2 data-bbox="557 375 963 406">Single step control EC 400</h2> <p data-bbox="557 411 1036 654">Each program can be executed in single-step mode. A safety prompt is displayed before the program starts. The individual program steps are indicated in the display. A "Cleaning" program might be displayed as follows:</p> <table border="1" data-bbox="565 694 991 901"> <tr><td>01: Probe in SERVICE</td><td></td></tr> <tr><td>02: Cleaner</td><td>0020 sec</td></tr> <tr><td>03: Rinse water ON</td><td>0060 sec</td></tr> <tr><td>04: Rinse water OFF</td><td>0002 sec</td></tr> <tr><td>05: Probe in MEASURE</td><td>0005 sec</td></tr> <tr><td>06: Program end</td><td></td></tr> </table> <h2 data-bbox="557 1133 778 1165">Start program</h2> <p data-bbox="557 1173 991 1236">Here you can select a program for test purposes:</p> <ul data-bbox="557 1244 694 1452" style="list-style-type: none"> Clean Cal 2point Cal 1point Parking User 1 User 2 	01: Probe in SERVICE		02: Cleaner	0020 sec	03: Rinse water ON	0060 sec	04: Rinse water OFF	0002 sec	05: Probe in MEASURE	0005 sec	06: Program end	
01: Probe in SERVICE														
02: Cleaner	0020 sec													
03: Rinse water ON	0060 sec													
04: Rinse water OFF	0002 sec													
05: Probe in MEASURE	0005 sec													
06: Program end														

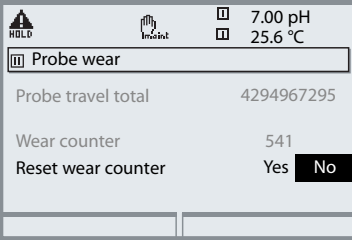

Probe Wear

“Maintenance / Probe control” Menu

Menu	Display	Maintenance
		<p>Probe wear</p> <p>There are 2 counters:</p> <ul style="list-style-type: none">• Probe stroke counter Counts the strokes throughout the probe life cycle and cannot be reset by the user (displayed in gray).• Wear counter The wear counter can be set to a value of max. 9999 strokes. When this value is reached, a message will be generated (e.g. for preventive maintenance). This counter can be reset by the user.

Diagnostics Functions

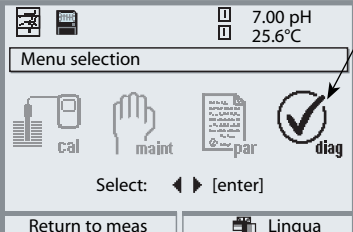

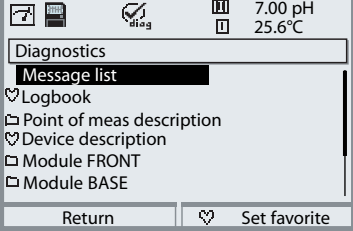
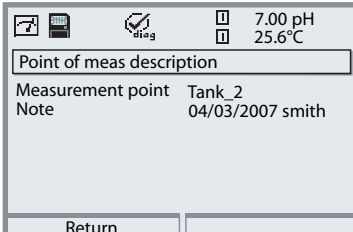
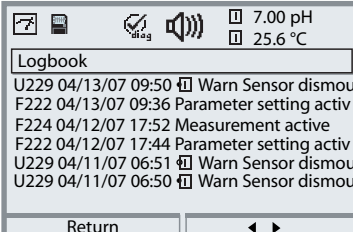
General Status Information of the Measuring System
 Select menu: Diagnostics - Logbook

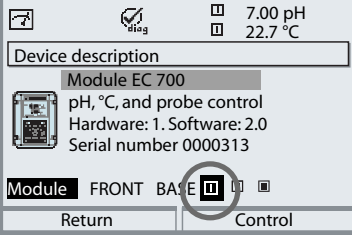
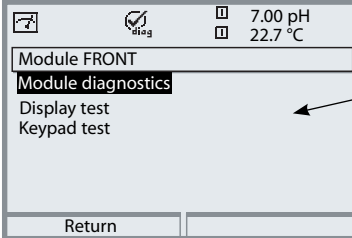
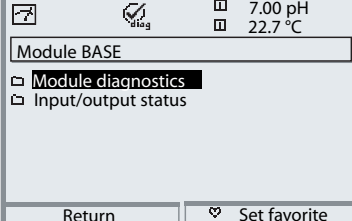
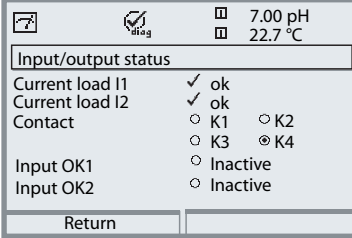
Menu	Display	Diagnostics functions
		<p>Call up diagnostics From the measuring mode: Press menu key to select menu. Select diagnostics using arrow keys, confirm with enter.</p>
		<p>The “Diagnostics” menu gives an overview of all functions available. Functions which have been set as “Favorite” can be directly accessed from the measuring mode.</p>
		<p>Point of meas description Allows entering a tag number and a note. Select position: left/right arrow key, select character: up/down arrow key. Confirm the entry with enter.</p>
		<p>Logbook The last 50 events are recorded with message identifier, date, time, and module concerned. This permits quality management documentation to ISO 9000 et seq. Extended logbook: SmartMedia card (SW 700-104)</p>

Menu	Display	Diagnostics functions
		<p>Device description</p> <p>Select module using arrow keys: Provides information about all modules installed: Function, serial number, hardware and software version, and device options.</p>
		<p>FRONT module</p> <p>The module contains the display and keypad control. Test possibilities:</p> <ul style="list-style-type: none"> • Module diagnostics • Display test • Keypad test
		<p>BASE module</p> <p>The module generates the standard output signals. Test possibilities:</p> <ul style="list-style-type: none"> • Module diagnostics • Input/output status
		<p>Example: Module BASE, input/output status.</p>

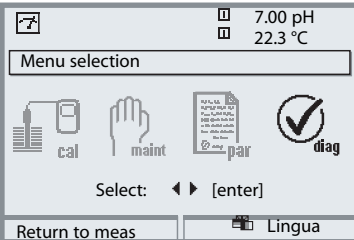

Diagnostics of EC 700

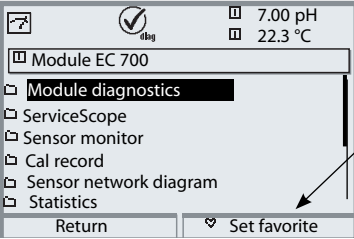
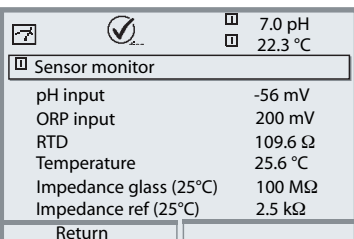
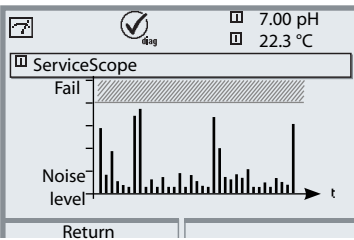





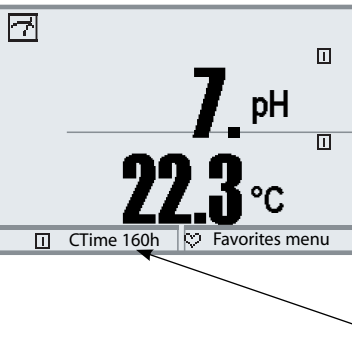

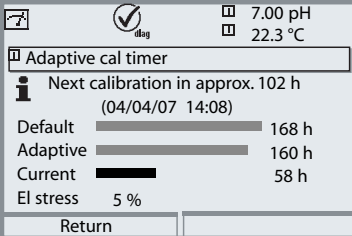
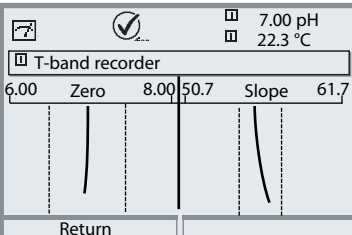
Module diagnostics / Sensor monitor / ServiceScope

Menu	Display	Module diagnostics / Sensor monitor / ServiceScope
		<p>Call up diagnostics</p> <p>From the measuring mode: Press menu key to select menu. Select diagnostics using arrow keys, confirm with enter. Then select "Module EC 700".</p>
		<p>The Diagnostics menu gives an overview of all diagnostics functions available. <u>Messages set as "Favorite"</u> can be called up directly from the measuring mode using a softkey. To configure: Parameter setting / System control / Function control matrix.</p>
		<p>Module diagnostics</p> <p>Internal function test.</p> <p>Sensor monitor (Fig.)</p> <p>Shows the values currently measured by the sensor. Important function for diagnostics and validation!</p>
		<p>ServiceScope (SW 700-004)</p> <p>Monitors the pH input signal. Displays the noise levels over the time. An error message is generated if the noise level exceeds the failure limit.</p>

Diagnostics of EC 700

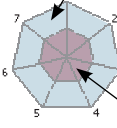

Calibration timer, Tolerance band recorder, Cal record, Sensor network diagram, Statistics

Menu	Display	Cal timer, Tolerance band recorder
		<p>Calibration timer</p> <p>After expiration of a presettable interval (Parameter setting, Module EC 700, Cal preset values), the calibration timer generates a warning message as a reminder that calibration is required. The remaining time can be indicated in the measuring mode by pressing a softkey (second-ary display: "CTime").</p>
		<p>Adaptive calibration timer</p> <p>The time until the next due calibration is automatically reduced depending on the electrode stress (temperature, pH value).</p>
		<p>Tolerance adjustment</p> <p>Records the tolerance ranges for zero and slope over the time. If the values determined by a calibration exceed the tolerance limits, the "Tolerance band exceeded, an adjustment can be executed automatically. Display can be graphical or as a listing. The tolerance band for zero and slope is configured during parameter setting (Module EC 700, Cal preset values).</p>

Menu	Display	Cal record, Sensor network diagram, Statistics												
 diag	<div style="border: 1px solid black; padding: 5px;"> <div style="display: flex; justify-content: space-between;">   diag 7.00pH 24.2°C </div> <div style="border: 1px solid black; padding: 2px; margin-top: 5px;"> Cal record </div> <table style="width: 100%; border-collapse: collapse;"> <tr><td>Active adjustment</td><td>05.04.07 09:34</td></tr> <tr><td>Sensor type</td><td>InPro3200SG</td></tr> <tr><td>Serial number</td><td>08151234</td></tr> <tr><td>Cal mode</td><td>Data entry</td></tr> <tr><td>Zero</td><td>+07.00 pH</td></tr> <tr><td>Slope</td><td>057.7 mV/pH</td></tr> </table> <div style="display: flex; justify-content: space-between; margin-top: 5px;"> Return Calibration data </div> </div>	Active adjustment	05.04.07 09:34	Sensor type	InPro3200SG	Serial number	08151234	Cal mode	Data entry	Zero	+07.00 pH	Slope	057.7 mV/pH	<h3>Cal record</h3> <p>Data of last adjustment/calibration, suitable for documentation to ISO 9000 and GLP/GMP (Date, time, calibration method, zero and slope, isothermal potential, information concerning calibration buffers and response times)</p>
Active adjustment	05.04.07 09:34													
Sensor type	InPro3200SG													
Serial number	08151234													
Cal mode	Data entry													
Zero	+07.00 pH													
Slope	057.7 mV/pH													
	<div style="border: 1px solid black; padding: 5px;"> <div style="display: flex; justify-content: space-between;">   diag 7.00pH 24.1°C </div> <div style="border: 1px solid black; padding: 2px; margin-top: 5px;"> Sensor network diagram </div> <div style="display: flex; align-items: center; margin-top: 10px;">  <div style="margin-left: 10px;"> <ol style="list-style-type: none"> 1 - Slope 2 - Zero point 3 - Ref impedance 4 - Glass impedance 5 - Response time 6 - Cal timer 7 - Calcheck </div> </div> <div style="display: flex; justify-content: space-between; margin-top: 5px;"> Return Info </div> </div> <div style="margin-top: 20px;"> <p>“Outer circle” Value within tolerance</p>  <p>Critical range – “inner circle” Value out of tolerance Tolerance can be modified with additional function.</p> </div>	<h3>Sensor network diagram</h3> <p>Graphical representation of the sensor parameters. Tolerance limit violations can be seen at a glance. Critical parameters are flashing. Parameters displayed in gray have been disabled during parameter setting or do not apply to the currently selected sensor.</p> <p>The tolerance limits (radius of “inner circle”) can be modified as desired.</p> <p>For more detailed information, press “Info” softkey.</p>												
	<div style="border: 1px solid black; padding: 5px;"> <div style="display: flex; justify-content: space-between;">   diag 7.00pH 0.2°C </div> <div style="border: 1px solid black; padding: 2px; margin-top: 5px;"> Statistics </div> <table style="width: 100%; border-collapse: collapse; margin-top: 5px;"> <tr><td colspan="2">Zero</td></tr> <tr><td>1st Cal</td><td>+07.00 pH 04/01/07 10:03</td></tr> <tr><td>Diff</td><td>+07.03 pH 04/01/07 17:24</td></tr> <tr><td>Diff</td><td>+07.02 pH 04/12/07 09:18</td></tr> <tr><td>Diff</td><td>+07.03 pH 04/28/07 10:47</td></tr> <tr><td colspan="2">Slope</td></tr> </table> <div style="display: flex; justify-content: space-between; margin-top: 5px;"> Return </div> </div>	Zero		1st Cal	+07.00 pH 04/01/07 10:03	Diff	+07.03 pH 04/01/07 17:24	Diff	+07.02 pH 04/12/07 09:18	Diff	+07.03 pH 04/28/07 10:47	Slope		<h3>Statistics</h3> <p>Indication of sensor data for the First Calibration (adjustment) and the last 3 calibrations compared to the First Calibration. (Date and time of First Calibration, zero and slope, impedance of glass and reference electrode, response time)</p>
Zero														
1st Cal	+07.00 pH 04/01/07 10:03													
Diff	+07.03 pH 04/01/07 17:24													
Diff	+07.02 pH 04/12/07 09:18													
Diff	+07.03 pH 04/28/07 10:47													
Slope														

Diagnostics of EC 400(X)

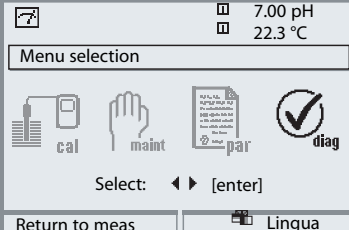
EC 400 status, EC 400 network diagram

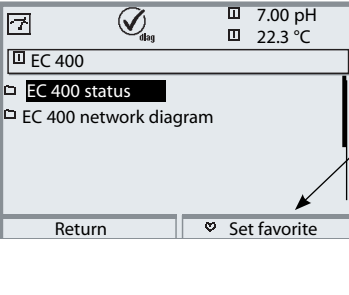
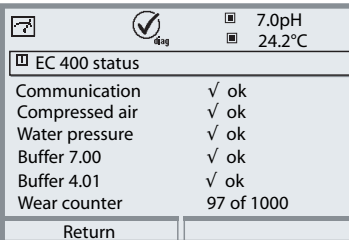
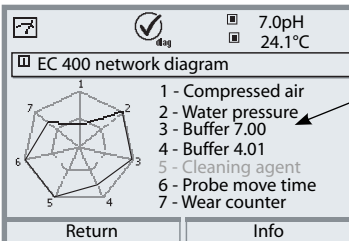
Menu	Display	EC 400 status, EC 400 network diagram												
	 <p>The display shows the main menu with a top status bar indicating 7.00 pH and 22.3 °C. Below the status bar is a 'Menu selection' section with icons for 'cal', 'maint', 'par', and 'diag'. The 'diag' icon is highlighted with a checkmark. Below the icons is a 'Select:' prompt with left and right arrow keys and '[enter]'. At the bottom are 'Return to meas' and 'Lingua' buttons.</p>	<p>Call up diagnostics</p> <p>From the measuring mode: Press menu key to select menu. Select diagnostics using arrow keys, confirm with enter. Then select Probe control.</p>												
	 <p>The display shows the 'EC 400' diagnostics menu. The top status bar shows 7.00 pH and 22.3 °C. Below it is a list of options: 'EC 400', 'EC 400 status', and 'EC 400 network diagram'. The 'EC 400 status' option is highlighted. At the bottom are 'Return' and 'Set favorite' buttons.</p>	<p>The Diagnostics menu gives an overview of all diagnostics functions available. <u>Messages</u> set as "Favorite" can be called up directly from the measuring mode using a softkey. To configure: Parameter setting / System control / Function control matrix.</p>												
	 <p>The display shows the 'EC 400 status' screen. The top status bar shows 7.0pH and 24.2°C. Below it is a list of status items:</p> <table border="0"> <tr><td>Communication</td><td>✓ ok</td></tr> <tr><td>Compressed air</td><td>✓ ok</td></tr> <tr><td>Water pressure</td><td>✓ ok</td></tr> <tr><td>Buffer 7.00</td><td>✓ ok</td></tr> <tr><td>Buffer 4.01</td><td>✓ ok</td></tr> <tr><td>Wear counter</td><td>97 of 1000</td></tr> </table> <p>At the bottom is a 'Return' button.</p>	Communication	✓ ok	Compressed air	✓ ok	Water pressure	✓ ok	Buffer 7.00	✓ ok	Buffer 4.01	✓ ok	Wear counter	97 of 1000	<p>EC 400 Status</p> <p>The media / ports at the media adapter are checked. The texts for the media are entered by the user during the installation (here, for example "Buffer 7.00")</p>
Communication	✓ ok													
Compressed air	✓ ok													
Water pressure	✓ ok													
Buffer 7.00	✓ ok													
Buffer 4.01	✓ ok													
Wear counter	97 of 1000													
	 <p>The display shows the 'EC 400 network diagram' screen. The top status bar shows 7.0pH and 24.1°C. Below it is a graphical representation of a sensor network with 7 numbered nodes. A legend to the right lists the nodes:</p> <ol style="list-style-type: none"> 1 - Compressed air 2 - Water pressure 3 - Buffer 7.00 4 - Buffer 4.01 5 - Cleaning agent 6 - Probe move time 7 - Wear counter <p>At the bottom are 'Return' and 'Info' buttons.</p>	<p>EC 400 network diagram</p> <p>Graphical representation of the parameters. Tolerance limit violations can be seen at a glance. For principle of function, see "Sensor network diagram".</p>												

Setting Diagnostics Messages as Favorite

Select menu: Parameter setting/System control/Function control matrix

Secondary Displays (1)

Here, additional values are displayed in the measuring mode according to the factory setting. When the respective softkey (2) is pressed, the process variables measured by the modules plus date or time are displayed. In addition, you can use the **softkeys (2)** to control functions.

To assign a function to a softkey, select

Parameter setting/System control/ Function control matrix

- Function which can be controlled by softkeys:
- Parameter set selection
- Favorites
- EC 400 (fully automated probe controller)

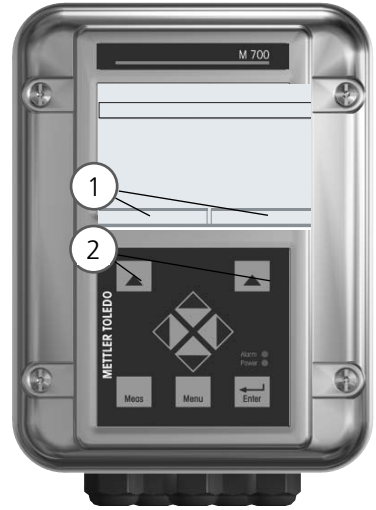

	ParSet	KI rec.	♥Fav	EC 400
Input OK2	<input type="radio"/>	<input type="radio"/>	<input type="radio"/>	-
Left softkey	<input type="radio"/>	<input type="radio"/>	<input type="radio"/>	-
Right softkey	<input type="radio"/>	<input type="radio"/>	<input checked="" type="radio"/>	-
Profibus DO 2	<input type="radio"/>	<input type="radio"/>	<input type="radio"/>	-

Return Connect

Example:



"Favorites" to be selected with "Right softkey"

To select a softkey function:

Select desired function using arrow keys, press "Connect" softkey and confirm with **enter**.

To deselect a function:

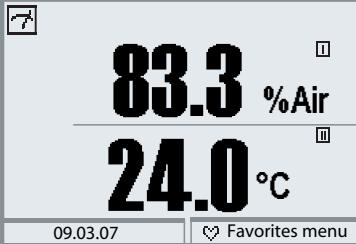
Press "Disconnect" softkey, confirm with **enter**.

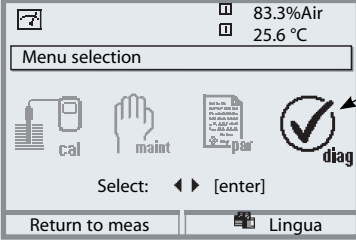
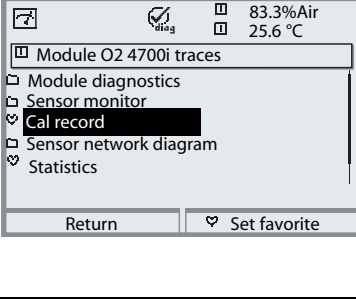
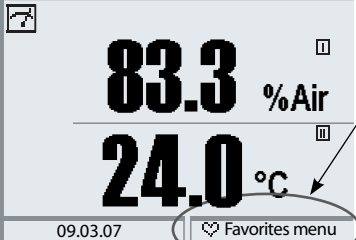

Menu	Display	Select favorites
		<p>Favorites menu</p> <p>Diagnostics functions can be called up directly from the measuring mode using a softkey. The "Favorites" are selected in the Diagnostics menu.</p>
		<p>Select favorites</p> <p>Press menu key to Menu selection. Select diagnostics using arrow keys, confirm with enter. Then select module and confirm with enter.</p>
		<p>Set/delete favorite:</p> <p>"Set favorite" allows activation of the selected diagnostic function directly from the measuring mode via softkey. The menu line is marked with a heart icon.</p>
		<p>Pressing the meas key returns to measurement. When the softkey has been assigned to "Favorites", "Favorites menu" is read in the secondary display (see "Function control matrix").</p>

Notice:

When one of the softkeys has been assigned to the "Favorites menu" function, diagnostic functions which have been set as "Favorite" can be directly called up from the measuring mode.

Diagnostics Functions

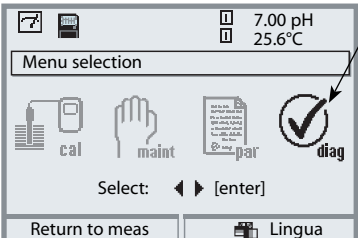
General status information of the measuring system
 Select menu: Diagnostics - Message list

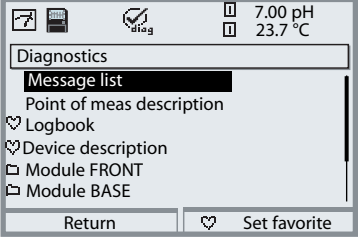
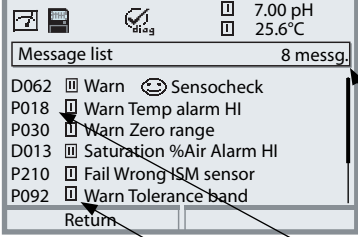
Menu	Display	Diagnostics functions
		<p>Call up diagnostics From the measuring mode: Press menu key to select menu. Select diagnostics using arrow keys, confirm with enter.</p>
		<p>The “Diagnostics” menu gives an overview of all functions available. Functions which have been set as “Favorite” can be directly accessed from the measuring mode.</p>
		<p>Message list Shows the currently activated warning or failure messages in plain text.</p> <p>Number of messages When there are more than 7 messages, a vertical scrollbar appears. Scroll with the up/down arrow keys.</p> <p>Message identifier See message list for description.</p> <p>Module identifier Specifies the module that has generated the message.</p>

Messages

FRONT 700-011 Module FRONT 700(X)-015 Module

No.	FRONT message	Message type
F008	Meas. processing (factory settings)	FAIL
F009	Module failure (Firmware Flash check sum)	FAIL
F060	KI process window exceeded (acknowledgeable message)	User-defined
F061	KI recorder parameter	WARN
F080	Reserved	
F081	Reserved	
F082	Reserved	
F083	Reserved	
F084	Reserved	
F085	Reserved	
F086	Reserved	
F087	Reserved	
F090	Reserved	
F091	Reserved	
F092	Reserved	
F093	Reserved	
F094	Reserved	
F095	Reserved	
F096	Reserved	
F097	Reserved	
F200	CRC error PAR	FAIL
F201	Communications error (system bus)	FAIL
F202	System failure	FAIL
F210	Device diagnostics (Self test signals error)	WARN
F211	Card error (SmartMedia)	WARN
F212	Time/date	WARN
F213	Module temperature (range exceeded)	WARN
F215	Memory card full	WARN

Messages

No.	FRONT message	Message type
F216	AuditTrail card	FAIL
F220	Calibration active	Text
F221	Maintenance active	Text
F222	Parameter setting active	Text
F223	Diagnostics active	Text
F225	Measurement active	Text
F226	Power supply OFF	Text
F227	Power supply ON	Text
F228	Software update	Text
F229	Wrong passcode	Text
F230	Factory setting	Text
F231	Configuration changed	Text
F232	Module equipment IS/non-IS	FAIL
F233	Module equipment IS	FAIL

Messages

BASE 700-021 Module
BASE 700(X)-025/VPW Module
BASE 700(X)-026/24V Module

No.	BASE message	Message type
B008	Meas. processing (factory settings)	FAIL
B009	Module failure (Firmware Flash check sum)	FAIL
B070	Current I1 Span	WARN
B071	Current I1 <0/4 mA	WARN
B072	Current I1 > 20 mA	WARN
B073	Current I1 Load error	FAIL
B074	Current I1 Parameter	WARN
B075	Current I2 Span	WARN
B076	Current I2 <0/4 mA	WARN
B077	Current I2 > 20 mA	WARN
B078	Current I2 Load error	FAIL
B079	Current I2 Parameter	WARN
B200	Rinsing program active	Text
B254	Module reset	Text

Messages

pH 2700(X) Module pH 2700i(X) Module EC 700(X) Module

No.	pH message	Message type
P008	Meas. processing (factory settings)	FAIL
P009	Module failure (Firmware Flash check sum)	FAIL
P010	pH range	FAIL
P011	pH Alarm LO_LO	FAIL
P012	pH Alarm LO	WARN
P013	pH Alarm HI	WARN
P014	pH Alarm HI_HI	FAIL
P015	Temperature range	FAIL
P016	Temperature Alarm LO_LO	FAIL
P017	Temperature Alarm LO	WARN
P018	Temperature Alarm HI	WARN
P019	Temperature Alarm HI_HI	FAIL
P020	ORP range	FAIL
P021	ORP Alarm LO_LO	FAIL
P022	ORP Alarm LO	WARN
P023	ORP Alarm HI	WARN
P024	ORP Alarm HI_HI	FAIL
P025	rH range	WARN
P026	rH Alarm LO_LO	FAIL
P027	rH Alarm LO	WARN
P028	rH Alarm HI	WARN
P029	rH Alarm HI_HI	FAIL
P030	Zero range	WARN
P035	Slope range	WARN
P040	Isotherm potential Uis range	WARN
P045	mV range	WARN
P046	mV Alarm LO_LO	FAIL

Messages

No.	pH message	Message type
P047	mV Alarm LO	WARN
P048	mV Alarm HI	WARN
P049	mV Alarm HI_HI	FAIL
P050	man. Temperature range	FAIL
P060	SENSOFACE -BAD-: Slope	User-defined
P061	SENSOFACE -BAD-: Zero	User-defined
P062	SENSOFACE -BAD-: Ref impedance (Sensochek)	User-defined
P063	SENSOFACE -BAD-: Glass impedance (Sensochek)	User-defined
P064	SENSOFACE -BAD-: Response time	User-defined
P065	SENSOFACE -BAD-: Calibration timer	WARN
P066	SENSOFACE -BAD-: Calcheck	User-defined
P069	SENSOFACE -BAD-: Calimatic (Zero/slope)	WARN
P070	SENSOFACE -BAD-: Sensor wear	User-defined
P071	SENSOFACE -BAD-: ISFET leakage current	User-defined
P090	Buffer offset (buffer table to be entered):	WARN
P091	Zero offset ORP	WARN
P092	Tolerance band	WARN
P110	CIP counter	User-defined
P111	SIP counter	User-defined
P112	Autoclaving counter	User-defined
P113	Sensor operating time (duration of use)	User-defined
P114	ISFET characteristic	User-defined
P115	Membrane body changes	User-defined
P120	Wrong ISM sensor	FAIL
P121	ISM sensor (error in factory settings/characteristics)	FAIL
P122	ISM sensor memory (error in cal data records)	WARN
P123	New sensor, adjustment required	WARN
P130	SIP cycle counted	Text
P131	CIP cycle counted	Text
P200	Noise level at pH input	FAIL
P201	Cal temp	WARN

Messages

No.	pH message	Message type
P202	Cal: Buffer unknown	Text
P203	Cal: Identical buffers	Text
P204	Cal: Buf interchanged	Text
P205	Cal: Sensor unstable	Text
P206	Cal: Slope	WARN
P207	Cal: Zero	WARN
P208	Cal: Sensor failure (ORP check)	FAIL
P254	Module reset	Text

No.	Calculation Block PH / PH messages	Message type
A010	pH-Diff Range	FAIL
A011	pH-Diff Alarm LO_LO	FAIL
A012	pH-Diff Alarm LO	WARN
A013	pH-Diff Alarm HI	WARN
A014	pH-Diff Alarm HI_HI	FAIL
A015	Temperature-Diff Range	FAIL
A016	Temperature-Diff Alarm LO_LO	FAIL
A017	Temperature-Diff Alarm LO	WARN
A018	Temperature-Diff Alarm HI	WARN
A019	Temperature-Diff Alarm HI_HI	FAIL
A020	ORP-Diff Range	FAIL
A021	ORP-Diff Alarm LO_LO	FAIL
A022	ORP-Diff Alarm LO	WARN
A023	ORP-Diff Alarm HI	WARN
A024	ORP-Diff Alarm HI_HI	FAIL

Messages

EC 400 with EC 700 Module

No.	EC 400 Message	Message type
U190	EC 400 Buffer I almost empty	WARN
U191	EC 400 Buffer II almost empty	WARN
U192	EC 400 Cleaner almost empty	WARN
U194	EC 400 Buffer I empty	FAIL
U195	EC 400 Buffer II empty	FAIL
U196	EC 400 Cleaner empty	FAIL
U219	Firmware Probe control	WARN
U220	EC 400 Switch Compressed air	FAIL
U221	Sensor dismantled	
U222	Reserved	FAIL
U224	EC 400 flooded	FAIL
U225	EC 400 Probe valve defective	FAIL
U226	Probe Limit position switch	FAIL
U227	Probe limit position SERVICE	FAIL
U228	Reserved	
U229	Reserved	
U230	Probe Limit position MEASURE	FAIL
U231	Probe Move time MEASURE	WARN
U232	Proble wear counter	WARN
U233	EC 400 Switch Water pressure	WARN
U234	Probe move time SERVICE	WARN
U235	Reserved	
U236	EC 400 No pump I	WARN
U237	EC 400 No pump II	WARN
U238	EC 400 No pump III	WARN
U239	EC 400 No aux. valve 1	WARN
U240	EC 400 No aux. valve 2	WARN
U241	Check Rinse water	WARN

Messages

No.	EC 400 Message	Message type
U242	Check buffer I	WARN
U243	Check buffer II	WARN
U244	Check cleaner	WARN
U245	Check Add. medium 1	WARN
U246	Check Add. medium 2	WARN
U248	EC 400 Water valve	WARN
U251	EC 400 Calibration error	WARN
U252	EC 400 Communication error	WARN
U253	Probe control	WARN

EC 400(X) Error Messages

NAMUR class	M 700 contacts			DCS34 / Control Alarm	Message (M 700)
	Fct.chk	Failure	Maint req.		
MAINT REQ.			active		Probe move time SERVICE (U234)
MAINT REQ.			active		Probe move time MEASURE (U231)
FAIL		active		active	Probe limit position SERVICE (U227)
FAIL		active		active	Probe limit position MEASURE (U230)
FAIL		active		active	Compressed air switch (U220)
FAIL		active		active	EC 400 flooded (U224)
FAIL	active				Sensor dismounted (U221)

Cause	System reaction	Reset	Remark
<ul style="list-style-type: none"> - Low air pressure - Probe sluggish - Filter choked - Move time too long 	None, message only	By next smooth probe movement	Limit position not reached at the first trial.
<ul style="list-style-type: none"> - Low air pressure - Probe sluggish - Filter choked - Move time too long 	None, message only	By next smooth probe movement	Limit position not reached at the first trial.
<ul style="list-style-type: none"> - Probe defective - Probe sticky - SERVICE limit switch defective - Probe valve defective * - Pilot valve defective * 	None, message only	By next smooth probe movement	SERVICE limit position was not reached even after several trials
<ul style="list-style-type: none"> - Probe defective - Probe sticky - MEASURE limit switch - Probe valve defective * - Pilot valve defective * 	None, message only	By next smooth probe movement	MEASURE limit position was not reached even after several trials
<ul style="list-style-type: none"> - Media adapter untight - Failure in compressed-air supply - Pressure too low - P/E converter defective - Safety valve defective (shut) 	None, message only	Automatic as soon as pressure is provided	
<ul style="list-style-type: none"> - Tubings untight - Hose/tube torn off - Water valve leaking - Water stop defective - Sensor dismantled - Probe cylinder untight - Probe lines untight - Dismount guard defective 	<p>None, message only</p> <p>Probe does not move into MEAS position, Message</p>	<ul style="list-style-type: none"> - SERVICE request - When sensor has been remounted 	<p>Water has been stopped</p> <p>Message can only appear in SERVICE position Sensor can only be removed in SERVICE position</p>

EC 400(X) Error Messages

NAMUR class	M 700 contacts			DCS34 /	Message (M 700)	
	Fct.chk	Failure	Maint req.	Control Alarm		
MAINT REQ.			active		Sensor dismount guard defective (U229)	
MAINT REQ.			active		Buffer almost empty Err text from medium description (U190/U191)	
FAIL		active		active	Buffer empty Err text from medium description (U194/U195)	
MAINT REQ.			active		Cleaner almost empty Err text from medium description (U192)	
FAIL		active		active	Cleaner empty Err text from medium description (U196)	
MAINT REQ.			active		EC 400 Switch Water pressure (U220)	
MAINT REQ.			active		Proble wear counter (U232)	
MAINT REQ.			active		Media monitoring Err texts from medium description (U241 ... U246)	

Cause	System reaction	Reset	Remark
<ul style="list-style-type: none"> - Flow sensor defective - Air leak in probe cylinder - Probe lines untight 	None, message only	- Replace flow sensor or eliminate other cause of defect	
<ul style="list-style-type: none"> - Filling level below minimum - Float switch stuck - Check-back error (Open or short circuit in line) - Bottle untight 	None, message only	Automatic when buffer solution is topped up above min. level	Start immediately when intervals have expired
<ul style="list-style-type: none"> - Residual bottle contents used up - Float switch stuck - Check-back error (Open or short circuit in line) 	All programs requiring buffer solution are blocked	Automatic when buffer solution is topped up above min. level	Start immediately when intervals have expired
<ul style="list-style-type: none"> - Filling level below minimum - Float switch stuck - Check-back error (Open or short circuit in line) - Bottle untight 	None, message only	Automatic when cleaning solution is topped up above min. level	Start immediately when intervals have expired
<ul style="list-style-type: none"> - Residual bottle contents used up - Float switch stuck - Check-back error (Open or short circuit in line) 	All programs requiring cleaning solution are blocked	Automatic when cleaning solution is topped up	Start immediately when intervals have expired
<ul style="list-style-type: none"> - No water - Water pressure too low 	All programs requiring water are blocked	Automatic as soon as water pressure OK	Start immediately when intervals have expired
<ul style="list-style-type: none"> - Wear counter expired 	None, message only	Manual reset in maintenance menu	
<ul style="list-style-type: none"> - Wrong medium - Wrong medium temperature - Media mixed - System untight - Probe untight 	None, message only	Automatic as soon as medium OK	

EC 400(X) Error Messages

NAMUR class	M 700 contacts			DCS34 /	Message (M 700)	
	Fct.chk	Failure	Maint req.	Control Alarm		
MAINT REQ.			active	active	EC 400 Calibration error (U251)	

	Cause	System reaction	Reset	Remark
	<ul style="list-style-type: none"> - Buffers interchanged - Identical buffers - Buffer unknown - Cal temp - Sensor unstable - Zero too low/high - Slope too low/high 	Calibration aborted	Automatically after next fault-free calibration	

Specifications

Specifications of EC 700 module

pH/ORP input (EEx ia IIC)	Simultaneous measurement of pH and ORP with glass electrode or ISFET Input for glass electrode or ISFET Input for reference electrode Input for redox (ORP) electrode or auxiliary electrode
Measurement range (MR)	pH value -2.00 ... +16.00 ORP value -2000 ... +2000 mV rH value 0.0 ... 42.5
Adm. voltage ORP + pH [mV]	2000 mV
Adm. cable capacitance	< 2 nF
Glass electrode input **	Input resistance > 1 x 10 ¹² Ω Input current < 1 x 10 ⁻¹² A **** Impedance range 0,5 ... 1000 MΩ
Reference electrode input **	Input resistance > 1 x 10 ¹⁰ Ω Input current < 1 x 10 ⁻¹⁰ A **** Impedance range 0,5 ... 200 kΩ
Meas. error *** (display)	pH value < 0.02 TC < 0.001 pH/K ORP value < 1 mV TC < 0.05 mV/K
Temperature input (EEx ia IIC)	Pt 100/Pt 1000/NTC 30 kΩ/NTC 8.55 kΩ
Measurement range (MR)	2-wire connection, adjustable -50 ... +150 °C (Pt 100/Pt 1000) -20 ... +150 °C (NTC 30 kΩ) -10 ... +130 °C (NTC 8.55 kΩ, Mitsubishi)
Resolution	0.1 °C
Measurement error ***	0.2 % meas.val. + 0.5 K (< 1 K with NTC > 100 °C)
Temp compensation media-dependent	Reference temp 25 °C – Linear temperature coefficient, user-defined from -19.99 to 19.99 % / K – Ultrapure water 0 ... 150 °C – Table 0 ... 95 °C, user-defined in 5 K steps
Power output (EEx ia IIC)	for the operation of EC 400 Vo = +7.2 V Io = 200 mA Ri = 20 Ω Operating data: 6.8 V (±10%) / 15 mA

Specifications

ORP *	Automatic conversion to standard hydrogen electrode SHE when type of reference electrode is entered										
ORP calibration*	Zero offset 200 ... +200 mV										
pH sensor standardization *	1-/2-/3-point calibration (best fit line) Operating modes: <ul style="list-style-type: none">– Calimatic automatic buffer recognition– Input of individual buffer values– Product calibration– Data entry of premeasured electrodes Fine / standard / coarse <ul style="list-style-type: none">– Fixed buffer sets:<table><tr><td>1 Mettler-Toledo</td><td>2.00 / 4.01 / 7.00 / 9.21</td></tr><tr><td>2 Merck/Riedel</td><td>2.00 / 4.00 / 7.00 / 9.00 / 12.00</td></tr><tr><td>3 DIN 19267</td><td>1.09 / 4.65 / 6.79 / 9.23 / 12.75</td></tr><tr><td>4 NIST Standard</td><td>4.006 / 6.865 / 9.180</td></tr><tr><td>5 Technical buffers to NIST</td><td>1.68 / 4.00 / 7.00 / 10.01 / 12.46</td></tr></table>– Manually enterable buffer set with max. three buffer tables (Additional function SW700-002)	1 Mettler-Toledo	2.00 / 4.01 / 7.00 / 9.21	2 Merck/Riedel	2.00 / 4.00 / 7.00 / 9.00 / 12.00	3 DIN 19267	1.09 / 4.65 / 6.79 / 9.23 / 12.75	4 NIST Standard	4.006 / 6.865 / 9.180	5 Technical buffers to NIST	1.68 / 4.00 / 7.00 / 10.01 / 12.46
1 Mettler-Toledo	2.00 / 4.01 / 7.00 / 9.21										
2 Merck/Riedel	2.00 / 4.00 / 7.00 / 9.00 / 12.00										
3 DIN 19267	1.09 / 4.65 / 6.79 / 9.23 / 12.75										
4 NIST Standard	4.006 / 6.865 / 9.180										
5 Technical buffers to NIST	1.68 / 4.00 / 7.00 / 10.01 / 12.46										
Drift check*:	pH 0 ... 14; calibration range $\Delta\text{pH} = \pm 1$										
Calimatic buffer sets: *	25 ... 61 mV/pH; calibration range 80 ... 103 % -1000 ... +1000 mV										
Nom. zero *											
Nom. slope (25 °C) *											
V_{iso} *											
Calibration record	Recording of: zero, slope, V_{iso} , response time, calibration method with date and time										
Statistics	Recording of: Zero, slope, V_{iso} , response time, glass and reference impedance with date and time of the last three calibrations and the First Calibration										
Sensocheck	Automatic monitoring of glass and reference electrode, message can be disabled										
Sensoface	Provides information on the sensor condition: zero/slope, response time, calibration interval, Sensocheck, CalCheck, can be switched off										
CalCheck (DE 195 36 315 C2)	Monitoring of electrode calibration range during measurement										
Sensor network diagram	Graphic representation of the current sensor parameters in a network diagram on the display: slope, zero, reference impedance, glass impedance, response time, calibration timer, deviation from calibration range (CalCheck)										

Specifications

Sensor monitor	Direct display of measured values from sensor for validation, pH input, ORP input, glass el. impedance / ref. el. impedance, RTD, temperature
KI recorder (Additional function SW700-001)	Adaptive representation of a process flow with monitoring and signaling of critical parameters
Adaptive cal timer	Automatic adjustment of calibration interval (Sensoface signal), depending on measured values
ServiceScope (Additional function SW700-004)	Monitoring the inputs for overdrive graphical representation
Tolerance band recorder (Additional function SW700-005)	Tolerant calibration/adjustment, tolerance limits adjustable graphical recording of zero point and slope of the last 40 calibrations/adjustments
Sensor monitoring adjustable	Criteria for sensor network diagram, Sensoface and NAMUR messages individually adjustable
RS 485 (Ex ia IIC) Transfer rate Record	$V_o/V_i = 5\text{ V}$ $I_o/I_i = 250\text{ mA}$ $R_i = 20\ \Omega$ 1200 Bd for EC 400 8 data bits / 1 stop bit / parity odd HART Rev. 5
Unical controller Programs Diagnostics Maintenance	Manual, interval and time-controlled activation of calibration and rinsing programs 7 programs can be called up <ul style="list-style-type: none">• 3 programs with preset sequences, modifiable• 3 freely configurable programs, 1 service program EC 400 network diagram, graphical representation of EC 400 status Control of the individual valves and pumps with status indicators
* User-defined	
** To IEC 746 Part 1, at nominal operating conditions	
*** ± 1 count, plus sensor error	
**** At 20 °C, doubles every 10 K	

Specifications

General Data

Explosion protection

(IS module only)

ATEX: See rating plate: KEMA 03 ATEX 2056
II 2 (1) GD EEx ib [ia] IIC T4 T 70 °C

FM: NI, Class I, Div 2, GP A, B, C, D T4
with IS circuits extending into Division 1
Class I, Zone 2, AEx nA, Group IIC, T4
Class I, Zone 1, AEx me ib [ia] IIC, T4

CSA: NI, Class I, Div 2, Group A, B, C, D
with IS circuits extending into Division 1
AIS, Class I, Zone 1, Ex ib [ia] IIC, T4
NI, Class I, Zone 2, Ex nA [ia] IIC

EMC

Emitted interference
Immunity to interference

NAMUR NE 21 and
EN 61326 VDE 0843 Part 20 /01.98
EN 61326/A1 VDE 0843 Part 20/A1 /05.99
Class B
Industry

Lightning protection

EN 61000-4-5, Installation Class 2

Nominal operating conditions

Ambient temperature:
-20 ... +55 °C (Ex: max. +50 °C)
Rel. humidity: 10 ... 95 % not condensing

Transport/Storage temperature

-20 ... +70 °C

Screw clamp connector

Single wires and flexible leads up to 2.5 mm²

Appendix:

Minimum Spans for Current Outputs

The EC 700 module is a measuring module. It does not provide current outputs. Current outputs are provided by the BASE module (basic device) or by communication modules (e.g. Out, PID). The corresponding parameters must be set there.

The minimum current span shall prevent that the resolution limit of the measurement technology (± 1 count) is seen in the current.

EC 700 Module

pH	1.00
ORP	100.0
°C	10.0
mV	100.0
rH	1.00
°F	10.0

Calculation Block PH/PH

Diff pH	1.00
Diff ORP	100.0
Diff °C	10.0

Appendix:

Buffer Table Mettler-Toledo

°C	pH			
0	2,03	4,01	7,12	9,52
5	2,02	4,01	7,09	9,45
10	2,01	4,00	7,06	9,38
15	2,00	4,00	7,04	9,32
20	2,00	4,00	7,02	9,26
25	2,00	4,01	7,00	9,21
30	1,99	4,01	6,99	9,16
35	1,99	4,02	6,98	9,11
40	1,98	4,03	6,97	9,06
45	1,98	4,04	6,97	9,03
50	1,98	4,06	6,97	8,99
55	1,98	4,08	6,98	8,96
60	1,98	4,10	6,98	8,93
65	1,99	4,13	6,99	8,90
70	1,99	4,16	7,00	8,88
75	2,00	4,19	7,02	8,85
80	2,00	4,22	7,04	8,83
85	2,00	4,26	7,06	8,81
90	2,00	4,30	7,09	8,79
95	2,00	4,35	7,12	8,77

Appendix:

Buffer Table Merck / Riedel

°C	pH				
0	2,01	4,05	7,13	9,24	12,58
5	2,01	4,04	7,07	9,16	12,41
10	2,01	4,02	7,05	9,11	12,26
15	2,00	4,01	7,02	9,05	12,10
20	2,00	4,00	7,00	9,00	12,00
25	2,00	4,01	6,98	8,95	11,88
30	2,00	4,01	6,98	8,91	11,72
35	2,00	4,01	6,96	8,88	11,67
40	2,00	4,01	6,95	8,85	11,54
45	2,00	4,01	6,95	8,82	11,44
50	2,00	4,00	6,95	8,79	11,33
55	2,00	4,00	6,95	8,76	11,19
60	2,00	4,00	6,96	8,73	11,04
65	2,00	4,00	6,96	8,72	10,97
70	2,01	4,00	6,96	8,70	10,90
75	2,01	4,00	6,96	8,68	10,80
80	2,01	4,00	6,97	8,66	10,70
85	2,01	4,00	6,98	8,65	10,59
90	2,01	4,00	7,00	8,64	10,48
95	2,01	4,00,	7,02	8,64	10,37

Appendix:

Buffer Table DIN 19267

°C	pH				
0	1,08	4,67	6,89	9,48	13,95*
5	1,08	4,67	6,87	9,43	13,63*
10	1,09	4,66	6,84	9,37	13,37
15	1,09	4,66	6,82	9,32	13,16
20	1,09	4,65	6,80	9,27	12,96
25	1,09	4,65	6,79	9,23	12,75
30	1,10	4,65	6,78	9,18	12,61
35	1,10	4,65	6,77	9,13	12,45
40	1,10	4,66	6,76	9,09	12,29
45	1,10	4,67	6,76	9,04	12,09
50	1,11	4,68	6,76	9,00	11,98
55	1,11	4,69	6,76	8,96	11,79
60	1,11	4,70	6,76	8,92	11,69
65	1,11	4,71	6,76	8,90	11,56
70	1,11	4,72	6,76	8,88	11,43
75	1,11	4,73	6,77	8,86	11,31
80	1,12	4,75	6,78	8,85	11,19
85	1,12	4,77	6,79	8,83	11,09
90	1,13	4,79	6,80	8,82	10,99
95	1,13*	4,82*	6,81*	8,81*	10,89*

* extrapoliert / extrapolated / extrapolée

Appendix:

Buffer Table NIST Standard (DIN 19266: 2000-01)

°C	pH			
0				
5	1.668	4.004	6.950	9.392
10	1.670	4.001	6.922	9.331
15	1.672	4.001	6.900	9.277
20	1.676	4.003	6.880	9.228
25	1.680	4.008	6.865	9.184
30	1.685	4.015	6.853	9.144
37	1.694	4.028	6.841	9.095
40	1.697	4.036	6.837	9.076
45	1.704	4.049	6.834	9.046
50	1.712	4.064	6.833	9.018
55	1.715	4.075	6.834	9.985
60	1.723	4.091	6.836	8.962
70	1.743	4.126	6.845	8.921
80	1.766	4.164	6.859	8.885
90	1.792	4.205	6.877	8.850
95	1.806	4.227	6.886	8.833

Notice:

The pH(S) values of the individual charges of the secondary reference materials are documented in a certificate of an accredited laboratory. This certificate is supplied with the respective buffer materials. Only these pH(S) values shall be used as standard values for the secondary reference buffer materials. Correspondingly, this standard does not include a table with standard pH values for practical use. The table above only provides examples of pH(PS) values for orientation.

Appendix:

Buffer Table Techn. Buffers to NIST

°C	pH		
0	4.00	7.14	10.30
5	4.00	7.10	10.23
10	4.00	7.04	10.11
15	4.00	7.04	10.11
20	4.00	7.02	10.05
25	4.01	7.00	10.00
30	4.01	6.99	9.96
35	4.02	6.98	9.92
40	4.03	6.98	9.88
45	4.05	6.98	9.85
50	4.06	6.98	9.82
55	4.07	6.98	9.79
60	4.09	6.99	9.76
65	4.09 *	6.99 *	9.76 *
70	4.09 *	6.99 *	9.76 *
75	4.09 *	6.99 *	9.76 *
80	4.09 *	6.99 *	9.76 *
85	4.09 *	6.99 *	9.76 *
90	4.09 *	6.99 *	9.76 *
95	4.09 *	6.99 *	9.76 *

* Values complemented

SW 700-002: Buffer Sets to be Entered

Select menu: Parameter setting/System control/Buffer table
 Individual buffer set (with 3 buffer solutions) for pH measurement

Buffer Table

You can enter an individual buffer set (with 3 buffer solutions). To do so, you enter the nominal buffer values for the correct temperature (range 0 ... 95 °C, 5°C steps. Min. distance between buffers in the whole temperature range: 1 °C). Then this buffer set is available in addition to the permanently set standard buffer solutions in the "Calimatic buffer" menu (select "Table").

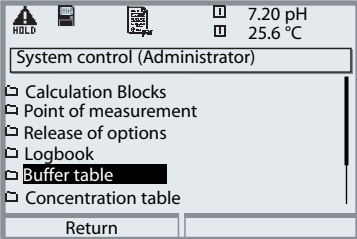
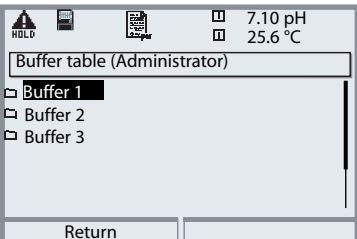
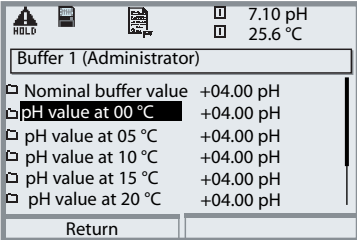
Menu	Display	Buffer table: Entering values
		<p>Enter buffer set</p> <ul style="list-style-type: none"> • Call up parameter setting • System control • Select "Buffer table"
		<ul style="list-style-type: none"> • Select buffer to be entered
		<ul style="list-style-type: none"> • Enter nominal buffer value and all other values for the correct temperature (right/left arrow keys to select position, up/down arrow keys to edit number, confirm with enter.)

The special buffer set is selected as follows:
 Parameter setting/Module pH/Cal preset values/Calimatic buffer/Table.

Overview of Parameter Setting

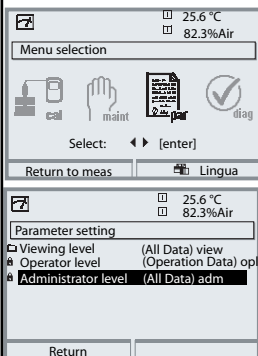

Parameter setting

Activated from measuring mode: Press **menu** key to select menu.

Select parameter setting using arrow keys, confirm with **enter**.

Administrator level

Access to all functions, also passcode setting.

Releasing or blocking a function for access from the Operator level.

Operator level

Access to all functions which have been released at the Administrator level. Blocked functions are displayed in gray and cannot be edited.

Viewing level

Only display, no editing possible!

System Control

Memory card (Option)

- Record logbook
- Register recorder
- Decimal separator
- Card full
- Format

Menu only appears with SmartMedia Card inserted.

Make sure that it is a memory card, not an update card.

Commercially available SmartMedia cards must be formatted before they can be used as memory card.

Copy configuration

The complete configuration of an analyzer can be written on a SmartMedia card. This allows transferring all device settings to other devices with identical equipment (exception: options and passcodes).

Parameter sets

- Load
- Save

2 parameter sets (A,B) are available in the analyzer.

The currently active parameter set is read on the display.

Parameter sets contain all settings except:

Sensor type, Options, System control settings

Up to 5 parameter sets (1, 2, 3, 4, 5) are available when a SmartMedia card (Option) is used.

Function control matrix

- Input OK2
- Left softkey
- Right softkey

Selecting the control element for the following functions:

- Parameter set selection
- KI recorder (Start/Stop)
- Favorites menu (selected diagnostics functions)
- EC 400 (fully automated probe controller)

Time/date

Selecting the display format, entry

Point of meas description

Can be called up in the diagnostics menu.

Release of options

A TAN is required to release an Option.

Software update

Software update from SmartMedia card (update card)

Logbook

Selecting events to be recorded

Buffer table

Entering own buffer set for automatic calibration

Factory setting

Resetting all parameters to factory setting

Passcode entry

Editing the passcodes

Parameter Setting Menu



Display Settings: FRONT Module

Languages

Measurement display	Representation of measured values on the display:
<ul style="list-style-type: none"> • Main display • Display format • Viewing angle 	<ul style="list-style-type: none"> - Selecting the number of primary values displayed (one or two) - Decimal places
Measurement recorder	Option: 2-channel, selection of process variable, start and end
<ul style="list-style-type: none"> • Time base • Zoom function • Min/Max display 	
KI recorder	Option: See more detailed "Options" manual

Signal Outputs and Inputs, Contacts: BASE Module

Output current I1, I2	2 current outputs, separately adjustable
<ul style="list-style-type: none"> • Variable • Curve • Output (0/4 - 20 mA) • Output filter • Behavior during messages <ul style="list-style-type: none"> - HOLD --- Current meas. --- Last meas. value --- Fixed 22 mA - 22 mA message 	<p>Behavior during messages</p> <p>Output current [mA]</p>
Contact K4	NAMUR Failure
<ul style="list-style-type: none"> • Contact type • ON delay • OFF delay 	
Contacts K3, K2, K1	Factory setting:
<ul style="list-style-type: none"> • Usage <ul style="list-style-type: none"> - Maintenance request - HOLD (function check) - Limit value (adjustable) - Rinse contact (adjustable) - Parameter set B active - USP output - KI recorder active - Sensoface • Conoller alarm (alarm output EC 400) • Contact type / ON/OFF delay 	<ul style="list-style-type: none"> K3: Maintenance request, K2: HOLD, K1: Limit - Variable, limit value, hysteresis, effective direction, ... - Rinsing interval, lead times, rinse duration, logbook entry, ...
Inputs OK1, OK2	Optocoupler - signal inputs
<ul style="list-style-type: none"> • OK1 usage <ul style="list-style-type: none"> - Signal level 	<ul style="list-style-type: none"> Off, HOLD (function check) active level switchable from 10 to 30 V or < 2 V, resp. For OK2 see System control/Function control matrix

Parameter Setting Menu



EC 700 Module

Input filter

Sensor data

- Sensor type
 - Temperature detection
 - Sensoface
 - Sensor monitoring
- Details
- Slope
 - Zero point
 - Sensocheck ref. el.
 - Sensocheck glass el.
 - Response time
 - Calcheck

Representation of measured values on the display:

- Select
- Selection for Measurement / Calibration

Cal preset values

- Calimatic buffer
- Mettler Toledo
- Merck/Riedel
- DIN 19267
- NIST standard
- NIST technical
- Hamilton
- Table
- Drift check
- Cal timer
- Cal tolerance band
- ORP check

TC process medium

Select: Off, linear, ultrapure water, table

ORP/rH value

- Reference electrode
- ORP conversion to SHE
- Calculate rH with factor

Delta function

Messages

- pH value
- ORP value
- rH value
- Temperature
- mV value

Parameter Setting Menu



EC 400 Probe Controller

Control	On / Off (automatic calibration)
Cal preset values	Select calibration method for automatic control
<ul style="list-style-type: none"> • Measuring module • Cal buffer 1 • Cal buffer 2 • Cal mode 	<ul style="list-style-type: none"> - Select measuring module - Menu entry depending on selected sensor type
Time control	Check / Adjustment
<ul style="list-style-type: none"> • Fixed interval • Week program 	Select program (Cleaning, Cal 2point, ..., Off) and interval Select up to 10 programs per weekday, adjustable for each program are: mode (individual start / interval), start and end time. Programmed weekdays can be copied.
Program flow	Configuring the detailed program sequences (Cleaning, Cal 1point calibration, Cal 2point calibration, Parking, User1 ... 2 - for free programming)
Installation	For first start-up or change of configuration
<ul style="list-style-type: none"> • Meas. procedure • External control (DCS) 	Continuous (probe always in the process) / Short-time When external controllers such as SiMatic® are used Setting the active signal level (10 ... 30 V or < 2 V)
<ul style="list-style-type: none"> - DCS inputs (36/39) - M/S input (42/43) - A/M input (40/41) - Outputs 1-3 (31-34) - DCS output 34 	Control inputs Control input Measuring / Service
<ul style="list-style-type: none"> • Sensor detection 	Select switch function (N/O or N/C) Measuring / Alarm
<ul style="list-style-type: none"> • Access manual control 	Monitoring as a dismount guard 4-digit access code; access from maintenance menu
<ul style="list-style-type: none"> • Probe type - Max. move time - Sealing water - Wear counter max. • Rinse water --- Monitoring --- Setpoint --- Adm. deviation 	
<ul style="list-style-type: none"> • Media adapter - Port I - Medium 1 - Displaced volume - Residual volume - Monitoring - Setpoint - Adm. deviation 	Usage: Metering pump / Off Buffer 7.00 25 / 50 / 75 / 100 ml 0 / 250 / 500 ml Process value / Temperature / Off 7.00 pH (default) 00.50 pH (default)

Parameter Setting Menu



EC 400 Probe Controller

- Media adapter
 - Port II Usage: Metering pump / Off
Buffer 4.01
 - Medium 2 25 / 50 / 75 / 100 ml
 - Displaced volume 0 / 250 / 500 ml
 - Residual volume Process value / Temperature / Off
 - Monitoring 7.00 pH (default)
 - Setpoint 00.50 pH (default)
 - Adm. deviation

- Port III Usage: Cleaning valve / Metering pump / Off
 - Medium Cleaning agent
 - Displaced volume 25 / 50 / 75 / 100 ml
 - Residual volume 0 / 250 / 500 ml
 - Monitoring Process value / Temperature / Off
 - Setpoint 9.21 pH (default)
 - Adm. deviation 00.50 pH (default)

- Additional media
 - Additional medium 1 On/Off
 - Medium Purge air _ _ _ _ _
 - Monitoring Process value / Temperature / Off
 - Setpoint 7.00 pH (default)
 - Adm. deviation 00.50 pH (default)

- Additional medium 2 On/Off
 - Medium Aux Medium _ _ _ _ _
 - Monitoring Process value / Temperature / Off
 - Setpoint 7.00 pH (default)
 - Adm. deviation 00.50 pH (default)

- Start-up Yes/No
Makes sure that the tubings between media adapter and probe are filled with calibration medium

Calibration Menu (Manual)



EC 700 Module

- Calimatic
- Entry of buffer values
- Product calibration
- Data entry
- ORP calibration

Index

A	
Activate monitoring	72
Activating the cal tolerance band.....	39
Adaptive calibration timer.....	40, 111
Additional media	79
Adjustment.....	81
Administrator level.....	30
Appendix.....	136
Application in hazardous locations.....	10
Audit Trail Log	9
Automatic buffer recognition (Calimatic)	90
Automatic temperature compensation.....	83
B	
BASE module.....	16
Behavior during messages.....	51
Buffer sets to be entered	142
Buffer table.....	142
Buffer tables	137
Buffer values, manual entry for calibration.....	92
C	
Cable glands.....	13
Calibration.....	80
Calibration by entering data from premeasured electrodes	96
Calibration methods	82
Calibration procedures.....	84
Calibration timer.....	40, 111
Calibration with sampling.....	94
Calimatic	90
Calimatic buffer	40
Call up parameter setting	32
Cal preset values.....	37
Cal preset values: EC 400	60
Cal preset values: Probe control.....	60

Index

Cal record.....	112
Change passcode	26
Cleaning (continuous).....	62
Configure function	72
Configure measurement display.....	27
Configure program flow	71
Connecting the EasyClean 400(X) probe controller	24
Contacts.....	47
Contact type.....	56
Control programs	76
Control via process control system (DCS)	75
Current output curves.....	48
Current outputs.....	47, 51
Current outputs, minimum spans.....	136

D

Data entry of premeasured electrodes.....	96
Device description.....	109
Device limits (messages).....	45
Device software	11
Diagnostics messages as favorite	114
Disposal.....	2
Drift check.....	37

E

EasyClean 400 (X) connection.....	24
EC 400(X) error messages.....	126, 128, 130
EC 400 network diagram.....	113
EC 400 status	113
EC Declaration of Conformity.....	3, 4
Edit program step	71
Electronic Signature	9
EMC	135
Enter program name.....	71
External control via DCS	74

Index

F

Factory setting	46
Failure.....	52
Favorites	114
FDA 21	9
First Calibration	82
Fixed interval (EC 400).....	61
FRONT module	15
Function check	52

G

Generating messages (measuring module).....	45
Graphic display	13

H

Hardware and software version	11
HOLD.....	52
Hysteresis.....	56

I

Icons.....	157
Individual buffer set	142
Inserting the module.....	21
Intended use.....	9
ISFET zero adjustment.....	100

L

LED.....	13
Limit value	56
Limit value, icons in the measurement display.....	56
Linear characteristic	48
Lock functions	31
Lock icon	31
Logarithmic output curve.....	49
Logbook	46, 108

Index

M	
Maintenance.....	102
Manual electrode calibration.....	86
Manual entry of buffer values.....	92
Manual temperature compensation.....	83
Measurement procedures.....	76
Measuring (Short-time).....	67
Media adapter.....	79
Media at media adapter.....	78
Media monitoring.....	78
Menu selection.....	25
Menu structure.....	14, 25
Message list.....	45, 116
Messages.....	117
Messages, behavior of current outputs.....	51
Message when the current range is exceeded.....	51
Minimum Spans for Current Outputs.....	136
Modular concept.....	12
Module equipment.....	16
Modules.....	15
Module software.....	11
Monitoring functions for calibration.....	97
O	
OK1,OK2 inputs.....	57
OK1/OK2 switching level.....	57
OK1 usage.....	57
OK2, selecting parameter set (A, B).....	58
OK inputs.....	47
One-point calibration.....	82
Operating levels.....	30
Operator level.....	30
Option release SW 3400-005.....	39
ORP calibration/adjustment.....	98

Index

ORP related to the standard hydrogen electrode.....	98
Output filter	50
Overview of parameter setting.....	143

P

Parameter set selection	58
Parameter setting (overview).....	145
Parameter setting, overview.....	143
Parameter setting: Probe control.....	59
Parameter setting of EC 700 (overview)	145
Parking	66
Park program.....	65
Passcode entry	26
Passcode lost	26
Probe.....	77
Probe control (menu).....	60
Probe controller connection	24
Probe maintenance	103
Probe wear	106
Product calibration.....	94
Program flow: Cal 1point, Continuous, Media monitoring off	64
Program flow: Cal 1point, Short-time, Media monitoring off	69
Program flow: Cal 2point, Continuous, Media monitoring off	63
Program flow: Cal 2point, Short-time, Media monitoring off	68
Program flow: Cleaning, Continuous, Media monitoring off.....	62
Program flow: Measurement, Short-time, Media monitoring off	67
Program flow: Parking	66
Program flow: Service	70
Program flows	62
Protective wiring.....	53

Q

Query actual device/module software	11
---	----

Index

R

Relay contacts.....	52
Relay contacts, usage.....	54, 55
Release (softkey function)	31
Replacing the front module	15
Return of products.....	2
Rinse contact	55
Rinse water.....	78

S

Safety information	10
Screw clamp connector.....	135
Sealing.....	15
Sealing water:.....	77
Secondary displays.....	13, 27
Selecting a calibration method.....	88
Select measurement procedure	74
Sensocheck.....	35
Sensoface	35
Sensoface criteria.....	36
Sensor detection.....	77
Sensor monitor	102, 110
Sensor network diagram.....	112
Serial number	11
Service	70
ServiceScope.....	110
Settings of sensor data	33
Shield	21
Short description	13
Signaling active parameter set via relay contact	58
Single step control EC 400.....	105
Slot for SmartMedia card	15
SmartMedia card	15
Softkeys.....	13, 27
Softwareversion	11

Index

Specifications.....	132, 135
Start (4 mA) and end (20 mA)	47
Start-up	29
Start-up (probe control parameter setting).....	79
Statistics	112
Switching parameter sets via OK2.....	58

T



















Table of contents	5
Temperature compensation during calibration.....	83
Temperature dependence of commonly used reference systems measured against SHE	99
Temp probe adjustment	102
Terminal compartment.....	16
Terminal plate	15
Terminal plates.....	20
Three-point calibration.....	82
Time control (EC 400).....	60
Time control: Fixed interval (probe control)	61
Time control: Probe control.....	60
Time control: Week program (EC 400).....	61
Time control: Week program (probe control)	61
Tolerance adjustment	111
Tolerance adjustment (menu)	37, 40
Trademarks	2
Two-point calibration	82













V

Viewing level	30
---------------------	----

W

Wait position	65
Warranty	2
Wear counter.....	77
Week program (EC 400)	61
Wiring examples.....	22

Icon	Explanation of icons important for the EC 700 module
	The analyzer is in measuring mode.
 	The analyzer is in calibration mode. HOLD mode is active.
 	The analyzer is in maintenance mode. HOLD mode is active.
 	The analyzer is in parameter setting mode. HOLD mode is active.
	The analyzer is in diagnostics mode.
NAMUR signals   	<p>HOLD. The NAMUR "HOLD" contact is active (factory setting: Module BASE, Contact K2, N/O contact). Current outputs as configured:</p> <ul style="list-style-type: none"> • Current meas.: The currently measured value appears at the current output • Last usable value: The last measured value is held at the current output • Fixed 22 mA: The output current is at 22 mA <p>Failure. The NAMUR "failure" contact is active (factory setting: Module BASE, Contact K4, N/C contact). To view error message, call up: Diagnostics menu/Message list</p> <p>Maintenance. The NAMUR "maintenance request" contact is active (factory setting: Module BASE, Contact K2, N/O contact). To view error message, call up: Diagnostics menu/Message list</p>
 man	Temperature by manual input
	Calibration is performed (progress display)
	Calibration - Step 1 of product calibration has been executed. The analyzer is waiting for the sample values.
TC	Temperature compensation for process medium is active (Linear/Ultrapure water/Chart)
Δ	Delta function is active (Output value = measured value – delta value)
	In the plaintext display in front of a menu line: Access to next menu level with enter
	In the plaintext display in front of a menu line when it has been blocked by the Administrator against access from the Operator level.
	Designates the module slot (1, 2, or 3), allowing the clear assignment of measured-value/parameter displays in the case of identical module types.
	Indicates the active parameter set. (The analyzer provides two parameter sets A and B. Up to 5 sets can be added using additional functions and SmartMedia card.)

Icon	Explanation of icons important for the UNICAL 9000(X) probe controller
	The probe is in MEASURE position ("PROCESS")
	The probe is in SERVICE position
	Rinse water active
	Metering pump at media adapter port I active.
	Metering pump at media adapter port II active.
	Metering pump at media adapter port III active.
	Additional medium 1 activated
	Additional medium 2 activated
	Valve at port III active
	Probe in SERVICE position
	Probe changes position
	Probe in MEASURE position ("PROCESS")

Menu Selection

EC 700 Module



Parameter setting	30
Logbook	46
Factory setting	46
BASE module	47
Current outputs.....	47
Current outputs: Behavior during messages.....	51
Relay contacts.....	54
Rinse contact	55
Limit value	56



Calibration and adjustment	80
Calimatic: automatic calibration.....	90
Calibration with manual entry of buffer values	92
Product calibration.....	94
Data entry - premeasured electrode	96
ORP calibration	98
ISFET zero adjustment.....	100



Maintenance	102
Sensor monitor	103
Temperature probe	103



Diagnostics	108
Point of meas description	108
Logbook	108
Diagnostics messages as favorite	114
Message list.....	116

Quick Access

Functions for EC 400) Controller



Parameter setting of EC 400	59
Time control (fixed interval / week program).....	60
Week program	61
Parameter setting: Program flows	62
Park program.....	65
Service program.....	70
Parameter Setting: Installation	73
Control via process control system.....	75
Configuring media monitoring.....	78



Maintenance EC 400	103
Probe maintenance	103
Manual control	104
Single step control	105
Probe wear	106



Diagnostics of EC 400	113
EC 400 status	113
EC 400 network diagram.....	113
Error messages of EC 400.....	126
Overview of icons	157
