

METTLER TOLEDO

Table of Contents

1	Introduction	3
1.1	Further documents and information	3
1.2	Explanation of conventions and symbols used	3
1.3	Acronyms and abbreviations	4
2	Safety Information	5
2.1	Definitions of signal words and warning symbols	5
2.2	Product specific safety notes	5
3	Design and Function	7
3.1	Overview components	7
3.2	Overview type plate	8
3.3	Overview operation keys	8
3.4	Display	10
4	Installation and Putting into Operation	11
4.1	Selecting the location	11
4.2	Scope of delivery	11
4.3	Unpacking	11
4.4	Installing components	12
4.5	Connecting the balance	12
4.6	Setting up the balance	13
4.6.1	Switching on the balance	13
4.6.2	Leveling the balance	13
4.6.3	Left/right operating of the glass draft shield	14
4.6.4	Adjusting the balance	14
4.7	Adjustment	15
4.7.1	Fully automatic adjustment (FACT)	15
4.7.2	Manual adjustment with internal weight	15
4.7.3	Manual adjustment with external weight	16
4.7.4	Customer fine adjustment (model dependent)	16
4.8	Performing a simple weighing	18
4.9	Transporting the balance	20
4.9.1	Transporting over short distances	20
4.9.2	Transporting over long distances	21
4.9.3	Packaging and storage	21
4.10	Weighing below the balance	21
5	The Menu	22
5.1	What is in the menu ?	22
5.2	Menu operation	23
5.3	Description of menu topic	24
5.3.1	Main menu	24
5.3.2	Basic menu	25
5.3.3	Advanced menu	26
5.3.4	Interface menu	31
6	Applications	39
6.1	Application piece counting	39
6.2	Application percent weighing	42
6.3	Application statistics	44
6.4	Application formulation (Net total)	46
6.5	Application totaling	49
6.6	Application multiplication factor weighing	51
6.7	Application division factor weighing	53
6.8	Application density	55

6.8.1	Density determination of solids	56
6.8.2	Density determination of liquids	57
6.8.3	Formulae used to calculate density	58
6.9	Application pipette check	60
6.10	Application routine test	64
6.11	Application diagnostics.....	66
6.11.1	Repeatability test.....	66
6.11.2	Display test	66
6.11.3	Key test.....	67
6.11.4	Motor test.....	67
6.11.5	Balance history.....	67
6.11.6	Adjustment history.....	68
6.11.7	Balance information	68
6.11.8	Service provider information	69
7	Communication with Peripheral Devices	70
7.1	USB - interface and installation.....	70
7.2	Send weight value via USB or RS232 to a PC using PC-Direct.....	70
7.2.1	PC-Direct via USB	71
7.2.2	PC-Direct via RS232	72
7.2.2.1	Installing SerialPortToKeyboard software	72
7.2.2.2	Balance settings.....	72
8	Maintenance	73
8.1	Maintenance table.....	73
8.2	Performing routine tests.....	73
8.3	Cleaning	73
8.3.1	Cleaning agents.....	74
8.3.2	Cleaning the glass draft shield	74
8.3.3	Cleaning the balance.....	75
8.3.4	Putting into operation after cleaning	76
9	Troubleshooting	77
9.1	Error messages	77
9.2	Error symptoms	78
9.3	Status icons	80
9.4	Putting into operation after fixing an error.....	80
10	Technical Data	82
10.1	General data	82
10.2	Model-specific data.....	83
10.3	Dimensions.....	85
10.4	Interface specification	86
10.4.1	RS232C interface	86
10.4.2	USB device.....	86
10.4.3	Aux connection	87
10.4.4	MT-SICS interface commands and functions.....	87
11	Disposal	88
12	Accessories and Spare Parts	89
12.1	Accessories.....	89
12.2	Spare parts	93
	Index	95

1 Introduction

Thank you for choosing a METTLER TOLEDO balance. The balance combines high performance with ease of use.

This document is based on the software version V 2.20.

EULA

The software in this product is licensed under the METTLER TOLEDO End User License Agreement (EULA) for Software.

▶ www.mt.com/EULA

When using this product you agree to the terms of the EULA.

1.1 Further documents and information

▶ www.mt.com/semimicro-analytical

This document is available in other languages online.

▶ www.mt.com/MS-Semi-RM

Instructions for cleaning a balance: "8 Steps to a Clean Balance"

▶ www.mt.com/lab-cleaning-guide

Search for software

▶ www.mt.com/labweighing-software-download

Search for documents

▶ www.mt.com/library

For further questions, please contact your authorized METTLER TOLEDO dealer or service representative.

▶ www.mt.com/contact

1.2 Explanation of conventions and symbols used

Conventions and symbols

Key and/or button designations and display texts are shown in graphic or bold text, e.g.,  **DATE**.

 **Note** For useful information about the product.



Refers to an external document.



This symbol indicates press key briefly (less than 1.5 s).



This symbol indicates press and hold key down (longer than 1.5 s).



This symbol indicates a flashing display.

Elements of instructions

In this manual, step-by-step instructions are presented as follows. The action steps are numbered and can contain prerequisites, intermediate results and results, as shown in the example. Sequences with less than two steps are not numbered.

- Prerequisites that must be fulfilled before the individual steps can be executed.
- 1 Step 1
 - ➔ Intermediate result
- 2 Step 2
 - ➔ Result

1.3 Acronyms and abbreviations

Original term	Explanation
AC	Alternating Current
ASTM	American Society for Testing and Materials
DC	Direct Current
EMC	Electromagnetic Compatibility
FACT	Fully automatic time- and temperature-controlled internal adjustment
FCC	Federal Communications Commission
GLP	Good Laboratory Practice
GMP	Good Manufacturing Practice
GWP	Good Weighing Practice
HID	Human Interaction Device
ID	Identification
INI	Installation Instructions
LAN	Local Area Network
LARS	LAB Repair and Service Software
LED	Light-Emitting Diode
LPS	Limited Power Source
MAC	Media Access Control
MT-SICS	METTLER TOLEDO Standard Interface Command Set
NA	Not Applicable
OI	Operating Instructions
OIML	Organisation Internationale de Métrologie Légale (International Organization of Legal Metrology)
PCB	Printed Circuit Board
POM	Polyoxymethylene
ProFACT	Professional FACT
RAM	Random Access Memory
RFID	Radio-frequency identification
RM	Reference Manual
SELV	Safety Extra Low Voltage
SMA	Service Manual
SNR	Serial Number
SOP	Standard Operating Procedure
TDNR	Type Definition Number
UM	User Manual
USB	Universal Serial Bus
USP	United States Pharmacopeia

2 Safety Information

Two documents named "User Manual" and "Reference Manual" are available for this instrument.

- The User Manual is printed and delivered with the instrument.
- The electronic Reference Manual contains a full description of the instrument and its use.
- Keep both documents for future reference.
- Include both documents if you transfer the instrument to other parties.

Only use the instrument according to the User Manual and the Reference Manual. If you do not use the instrument according to these documents or if the instrument is modified, the safety of the instrument may be impaired and Mettler-Toledo GmbH assumes no liability.

2.1 Definitions of signal words and warning symbols

Safety notes contain important information on safety issues. Ignoring the safety notes may lead to personal injury, damage to the instrument, malfunctions and false results. Safety notes are marked with the following signal words and warning symbols:

Signal words

DANGER	A hazardous situation with high risk, resulting in death or severe injury if not avoided.
WARNING	A hazardous situation with medium risk, possibly resulting in death or severe injury if not avoided.
CAUTION	A hazardous situation with low risk, resulting in minor or moderate injury if not avoided.
NOTICE	A hazardous situation with low risk, resulting in damage to the instrument, other material damage, malfunctions and erroneous results, or loss of data.

Warning symbols



General hazard: read the User Manual or the Reference Manual for information about the hazards and the resulting measures.



Electrical shock



Notice

2.2 Product specific safety notes

Intended use

This instrument is designed to be used in laboratories by trained staff. The instrument is intended for weighing purposes.

Any other type of use and operation beyond the limits of technical specifications without written consent from Mettler-Toledo GmbH is considered as not intended.

Responsibilities of the instrument owner

The instrument owner is the person holding the legal title to the instrument and who uses the instrument or authorizes any person to use it, or the person who is deemed by law to be the operator of the instrument. The instrument owner is responsible for the safety of all users of the instrument and third parties.

Mettler-Toledo GmbH assumes that the instrument owner trains users to safely use the instrument in their workplace and deal with potential hazards. Mettler-Toledo GmbH assumes that the instrument owner provides the necessary protective gear.

Personal protective equipment



Chemical resistant safety gloves are intended to protect hands against aggressive chemicals.



The protective goggles protect the eyes from flying parts and liquid splashes.

Safety notes



WARNING

Death or serious injury due to electric shock

Contact with parts that carry a live current can lead to death or injury.

- 1 Only use the METTLER TOLEDO power cable and AC/DC adapter designed for your instrument.
- 2 Connect the power cable to a grounded power outlet.
- 3 Keep all electrical cables and connections away from liquids and moisture.
- 4 Check the cables and the power plug for damage and replace them if damaged.



NOTICE

Damage to the instrument or malfunction due to the use of unsuitable parts

- Only use parts from METTLER TOLEDO that are intended to be used with your instrument.

3 Design and Function

3.1 Overview components

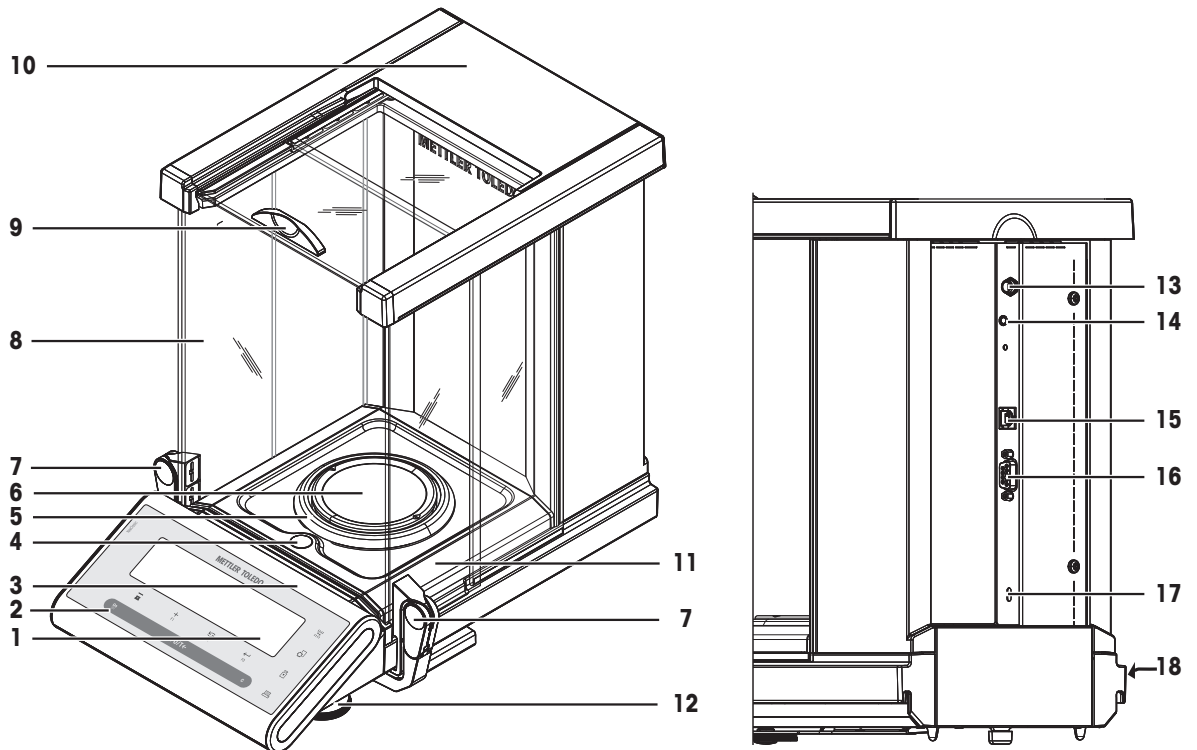

Components overview legend

1	Display	2	Operation keys
3	Model sticker (with approved models only)	4	Level indicator
5	Draft ring	6	Weighing pan
7	Handle/Coupling element for the operation of the draft shield doors	8	Glass draft shield
9	Handle for operation of the draft shield top door	10	Top cover
11	Drip tray	12	Leveling feet
13	Socket for AC/DC Adapter	14	Aux (connection for "ErgoSens" or foot-switch)
15	USB device interface	16	RS232C serial interface
17	Kensington slot for anti-theft purposes	18	Product label

3.2 Overview type plate

The balance type plate is located at the side of the balance and contains the following information (example illustration):

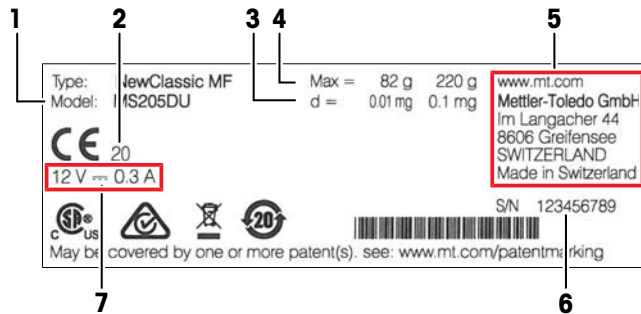





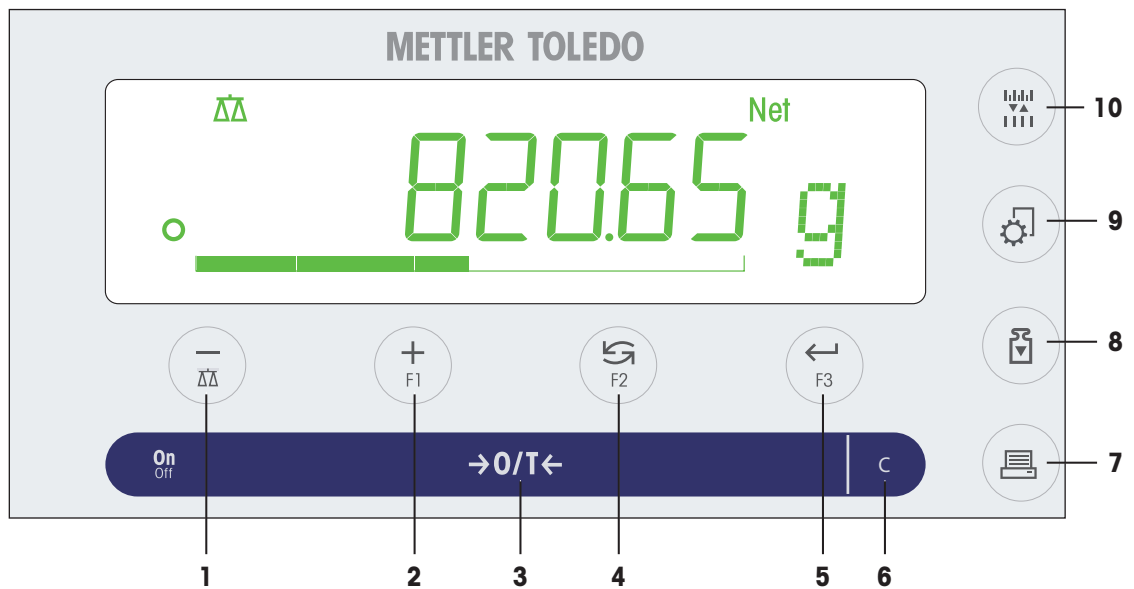







1	Model designation	2	Year of manufacture
3	Readability	4	Maximum capacity
5	Manufacturer	6	Serial number (SNR)
7	Power supply		

3.3 Overview operation keys



Terminal keys legend

No.	Key	Press briefly (less than 1.5 s)	Press and hold (longer than 1.5 s)
1		<ul style="list-style-type: none"> To navigate back (scroll up) within menu topics or menu selections Decrease (numerical) parameters within menu and in applications 	<ul style="list-style-type: none"> To select the weighing application Decrease (numerical) parameters quickly within menu and in applications

No.	Key	Press briefly (less than 1.5 s) 	Press and hold (longer than 1.5 s) 
2	 F1	<ul style="list-style-type: none"> To navigate forward (scroll down) within menu topics or menu selections Increase (numerical) parameters within menu and in applications 	<ul style="list-style-type: none"> To select assigned F1 application and entering the parameter settings of application. Default F1 application assignment: Piece counting Increase (numerical) parameters quickly within menu and in applications
3	On/Off  0/T 	<ul style="list-style-type: none"> Switch on Zero/Tare 	<ul style="list-style-type: none"> Switch off
4	 F2	<ul style="list-style-type: none"> With entries: scroll down To navigate through menu topics or menu selections To toggle between unit 1, recall value (if selected), unit 2 (if different from unit 1) and the application unit (if any) 	<ul style="list-style-type: none"> To select assigned F2 application and entering the parameter settings of application. Default F2 application assignment: Percent weighing
5	 F3	<ul style="list-style-type: none"> To enter or leave menu selection (from / to menu topic) To enter application parameter or switch to next parameter To confirm parameter 	<ul style="list-style-type: none"> To select assigned F3 application and entering the parameter settings of application. Default F3 application assignment: Statistics
6	C	<ul style="list-style-type: none"> Cancel and to leave menu without saving (one step back in the menu). 	no function
7		<ul style="list-style-type: none"> Printout display value Printout active user menu settings Transfer data 	no function
8		<ul style="list-style-type: none"> Execute predefined adjustment procedure 	no function
9		<ul style="list-style-type: none"> Enter or leave menu (Parameter settings) Save parameters 	no function
10		<ul style="list-style-type: none"> To change display resolution (1/10d function) while application is running <p> Note: not available with approved models in selected countries.</p>	no function

3.4 Display

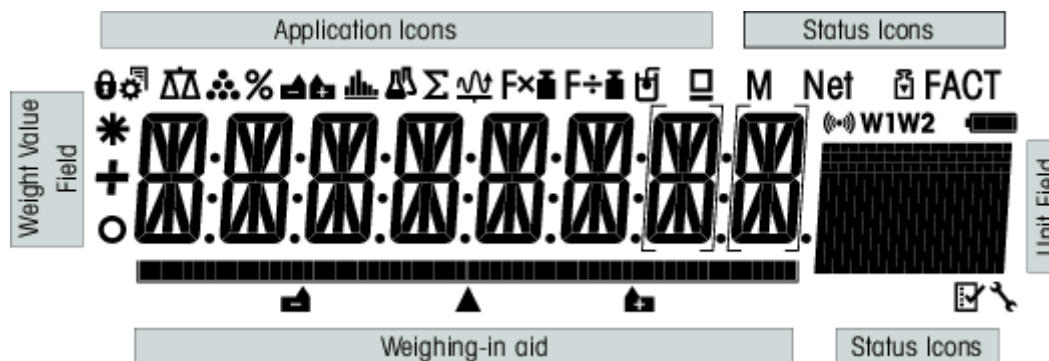

Application icons			
	Menu locked		Application formulation / Net total
	Menu setting activated		Application totaling
	Application weighing		Application multiplication factor
	Application piece counting		Application division factor
	Application percent weighing		Application density
	Application statistics		Application pipette check

While an application is running, the corresponding application icon appears at the top of the display.

Status icons			
M	Indicates stored value (Memory)		Applications diagnostics and routine test
Net	Indicates net weight values		Acoustic feedback for pressed keys activated
	Adjustments started	W1	Weighing range 1 (Dual Range models only)
FACT	FACT activated	W2	Weighing range 2 (Dual Range models only)
	Service reminder		Not used

Weight value field and weighing-in aid			
	Indicates negative values		Brackets to indicate uncertified digits (approved models only)
	Indicates unstable values		Marking of nominal or target weight
	Indicates calculated values		Not used
			Not used

Unit field						
GNctls%bahtlh msgPCStbidzjt kgmgm	g	gram	ozt	troy ounce	tls	Singapore taels
	kg	kilogram	GN	grain	tlf	Taiwan taels
	mg	milligram	dwt	pennyweight	tola	tola
	ct	carat	mom	momme	baht	baht
	lb	pound	msg	mesghal		
	oz	ounce	tlh	Hong Kong taels		

4 Installation and Putting into Operation

4.1 Selecting the location

A balance is a sensitive precision instrument. The location where it is placed will have a profound effect on the accuracy of the weighing results.

Requirements of the location

Place indoors on stable table

Ensure sufficient spacing

Level the instrument

Provide adequate lighting



Avoid direct sunlight

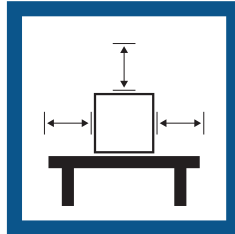
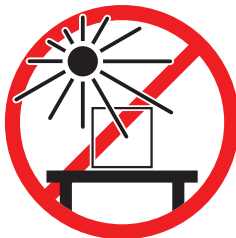

Avoid vibrations



Avoid strong drafts

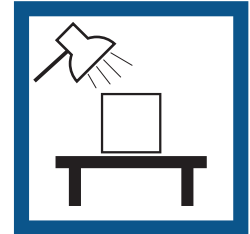

Avoid temperature fluctuations



Sufficient spacing for balances: > 15 cm all around the instrument

Take into account the environmental conditions. See "Technical Data".

4.2 Scope of delivery

- Balance with draft shield
- Weighing pan with pan support
- Draft ring
- Drip tray
- Protective cover
- AC/DC adapter
- Power cable (country specific)
- 1 User Manual
- Declaration of Conformity

4.3 Unpacking

Open the balance packaging. Check the balance for transport damage. Immediately inform a METTLER TOLEDO representative in the event of complaints or missing accessories.

Retain all parts of the packaging. This packaging offers the best possible protection for transporting the balance.

4.4 Installing components



CAUTION

Injury due to breaking glass

Careless handling of the glass components can lead to breakage off glass and damage cuttings.

- Always proceed focused and with care.

Push the side glass doors back as far as will go and place the following components on the balance in the specified order:

- 1 Place the drip tray (1) into the correct position.
- 2 Place the weighing pan (3).
- 3 Place the draft ring (2).

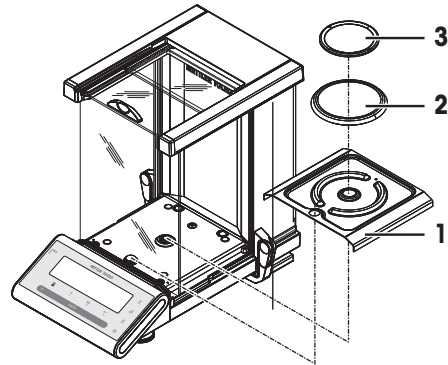

4.5 Connecting the balance



WARNING

Death or serious injury due to electric shock

Contact with parts that carry a live current can lead to death or injury.

- 1 Only use the METTLER TOLEDO power cable and AC/DC adapter designed for your instrument.
- 2 Connect the power cable to a grounded power outlet.
- 3 Keep all electrical cables and connections away from liquids and moisture.
- 4 Check the cables and the power plug for damage and replace them if damaged.



NOTICE

Damage to the AC/DC adapter due to overheating

If the AC/DC adapter is covered or in a container, it is not sufficiently cooled and will overheat.

- 1 Do not cover the AC/DC adapter.
- 2 Do not put the AC/DC adapter in a container.

- Install the cables so that they cannot be damaged or interfere with operation.
- Insert the power cable in a grounded power outlet that is easily accessible.

- 1 Connect the AC/DC adapter to the connection socket on the back of your balance (see figure) and to the power line.
 - 2 Screw the plug tight to the balance.
- ➔ The balance is ready for use.

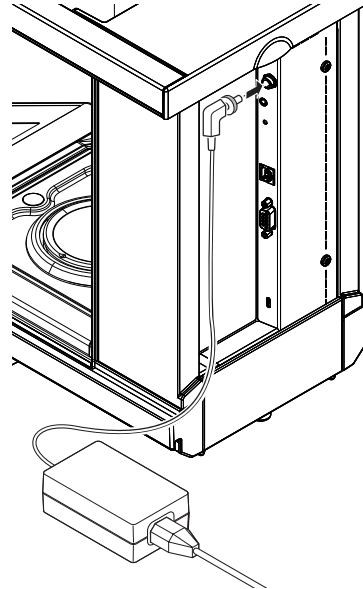

4.6 Setting up the balance

4.6.1 Switching on the balance

Before using the balance, it must be warmed up in order to obtain accurate weighing results. To reach operating temperature, the balance must be acclimatized and connected to the power supply for at least 60 minutes.

Switching on

- Press **On**.
 - ➔ The balance performs a display test. All segments in the display light up briefly, **WELCOME** and software version. Maximum load and readability appears briefly. (Startup **FULL** mode only).
- ➔ The balance is ready for weighing or for operation with the last active application.

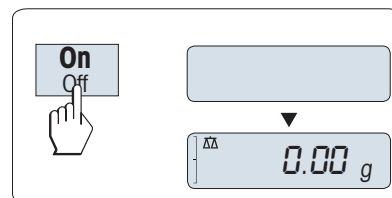

Legal-for-trade

Approved balances will execute an initial zero.

4.6.2 Leveling the balance

The balance has a level indicator and two adjustable leveling feet to compensate for slight irregularities in the surface of the weighing bench. The balance is exactly horizontal when the air bubble is in the middle of the level glass.

The balance must be leveled and adjusted each time it is moved to a new location.

To level it, proceed as follows:

- 1 Position your balance at the selected location.
- 2 Align the balance horizontally.

- Turning the two front leveling screws of the housing until the air bubble is in the inner circle of the level indicator.

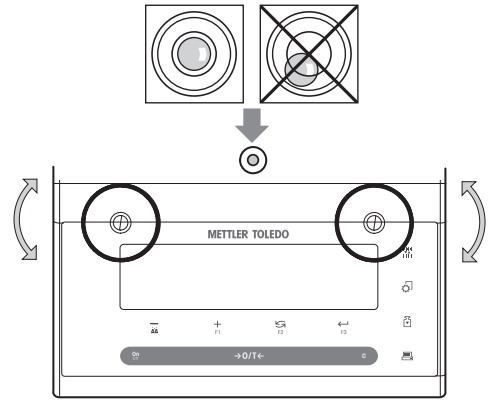

Example

Air bubble at 12 o'clock:



turn both feet clockwise.



Air bubble at 3 o'clock:



turn left foot clockwise, right foot counterclockwise.



Air bubble at 6 o'clock:



turn both feet counterclockwise.



Air bubble at 9 o'clock:



turn left foot counterclockwise, right foot clockwise.



4.6.3 Left/right operating of the glass draft shield

The glass draft shield of your balance can be adapted to the environmental conditions and your weighing style, as well as to the type of weighing and loading.

The position of the handles determines which door(s) of the draft shield (left, right, or both) is/are opened.

Try various different combinations by moving the external handles into the upper or lower position. We recommend you to set up the glass draft shield so that it only opens on the side where the balance is loaded. Your balance then works faster, because there are fewer troublesome currents of air than when both doors of the draft shield are opened together.

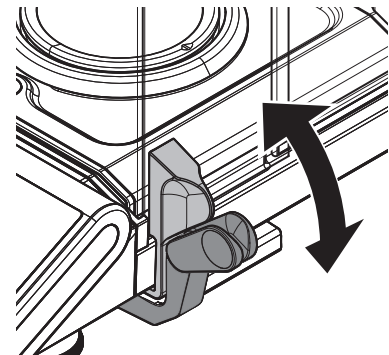

4.6.4 Adjusting the balance

To obtain accurate weighing results, the balance must be adjusted to match the gravitational acceleration at its location. This is also dependent on the ambient conditions. After reaching the operating temperature, it is important to adjust the balance in the following cases:

- Before the balance is used for the first time.
- If the balance has been disconnected from the power supply or in the event of power failure.
- After significant environmental changes, e.g., temperature, humidity, air draft or vibrations.
- At regular intervals during weighing service.

4.7 Adjustment



NOTICE

Before adjusting the balance, it must be warmed up.

4.7.1 Fully automatic adjustment (FACT)

By default, **FACT** is activated, allowing for fully automatic adjustment using the internal weight.

More information can be found in the section [The Menu ▶ Page 22].

The balance adjusts itself automatically:

- after the warm-up phase on connection to the power supply.
- when a change in the ambient conditions, e.g. the temperature, could lead to a noticeable deviation in the measurement.
- on a predefined time, **see** menu topic **FACT**.
- time interval. (with OIML accuracy class II approved models).

4.7.2 Manual adjustment with internal weight

- In the menu topic **CAL** (Adjustment) of advanced menu **ADJ.INT** must be selected.
- Weighing pan is unloaded.
- Press  to execute the internal adjustment.
 - ➔ The balance adjusts itself automatically.
- ➔ The adjusting is finished when the message **ADJ DONE** appears briefly on the display. The balance returns to the last active application and is ready for operation.

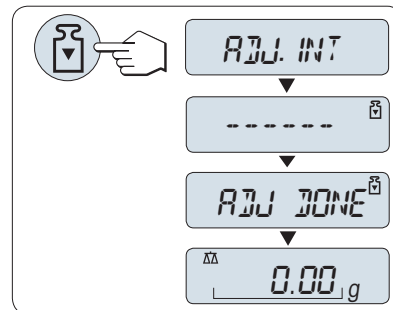

4.7.3 Manual adjustment with external weight



Note

We recommend to disable FACT.

- In the menu topic **CAL** (Adjustment) of advanced menu **ADJ.EXT** must be selected.
- Required adjustment weight is ready.
- Weighing pan is unloaded.

- 1 Press briefly to execute the external adjustment.
 - ➔ The required (predefined) adjustment weight value flashes on the display.
- 2 Place adjustment weight in center of pan.
 - ➔ The balance adjusts itself automatically.
- 3 Remove adjustment weight, when **0.00 g** flashes.
 - ➔ The adjusting is finished when the message **ADJ DONE** appears briefly on the display. The balance returns to the last active application and is ready for operation.

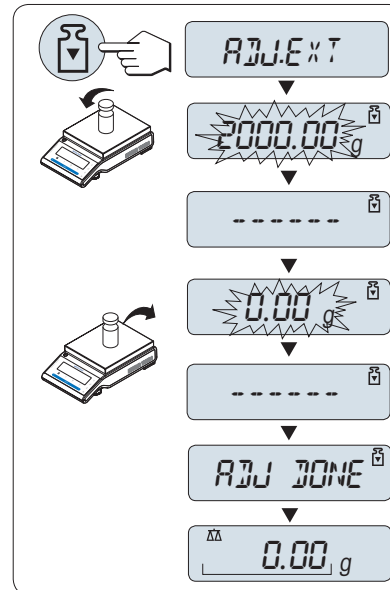

4.7.4 Customer fine adjustment (model dependent)



NOTICE

This function should be executed only by trained personnel.

The function customer fine adjustment **ADJ.CUST.F** allows you to adjust the value of the internal adjustment weight with your own adjustment weight. The adjustable range of the adjustment weight is possible only in a very small range. Customer fine adjustment impacts the function of internal adjustment. The customer fine adjustment can be deactivated at any time.



Note

- This feature is available on models with internal weight only.
- Because of certification legislation, approved models cannot be adjusted with customer fine adjustment (depending on selected countries' certification legislation).
- Use certificated weights.
- Balance and test weight have to be on operating temperature.
- Observe the correct environmental conditions.

Execute customer fine adjustment

- The balance is under measuring condition.
 - Required adjustment weight is ready.
 - Weighing pan is unloaded.
- 1 Select in the menu **ADVANCED: ADJ.CUST.F**
 - 2 Confirm **ADJ.CUST.F** with \leftarrow .
 - 3 To carry out this operation select **EXECUTE**.
 - 4 Start Adjustment with \leftarrow .
 - ➔ **SET REF.** appears briefly.
 - ➔ The last saved value flashes on the display.
 - 5 Select the target adjustment weight.
 - For coarse setting, press \rightarrow to change the value.
 - For fine setting, press $+$ to increase the value or press $-$ to decrease the value.
 - 6 Press and hold \leftarrow to confirm and execute **ADJ.CUST.F**.
 - ➔ The required adjustment weight value flashes in the display. This could take some time.
 - 7 Place required adjustment weight in center of pan.
 - 8 Remove adjustment weight when zero is flashing.
 - 9 Wait until **ADJ DONE** briefly appears.
 - ➔ The adjusting is finished when the message **ADJ DONE** appears briefly on the display. The balance returns to the last active application and is ready for operation
 - ➔ If the error message **WRONG ADJUSTMENT WEIGHT** appears, the weight is not within the allowed value range and could not be accepted. **ADJ.CUST.F** could not be executed.

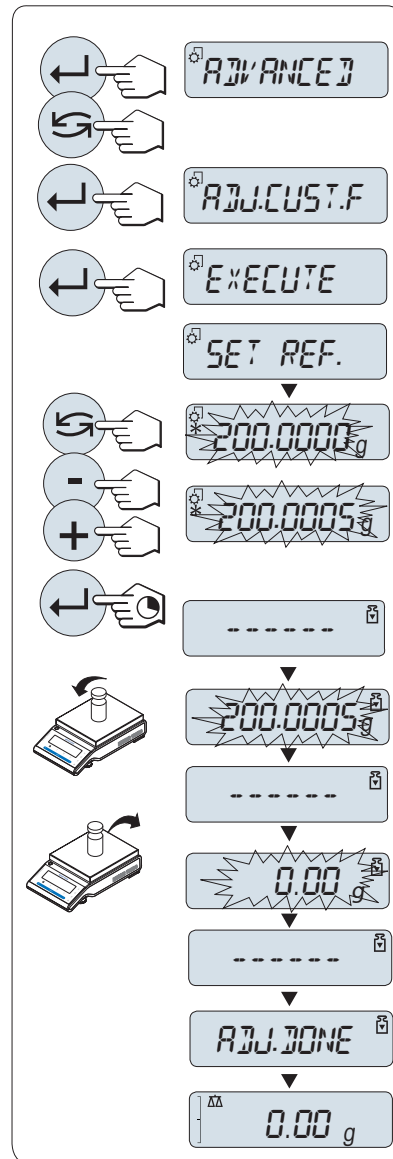

Note

Storing the adjustment is not required.

Deactivate customer fine adjustment

- 1 Select in the menu **ADVANCE.: ADJ.CUST.F**.
- 2 Confirm **ADJ.CUST.F** with \leftarrow .
- 3 To carry out this operation select **RESET**.
- 4 Start **RESET** by pressing \leftarrow .
 - ➔ **NO?** appears.
- 5 Select **YES?** and confirm with \leftarrow .
 - ➔ The adjusting is finished when the message **ADJ DONE** appears briefly on the display. The balance returns to the last active application and is ready for operation with initial adjustment.

4.8 Performing a simple weighing



The weighing application allows you to perform simple weighings and how you can accelerate the weighing process.

If your balance is not in the weighing mode, press and hold the $\Delta\Delta$ key down until **WEIGHING** appears in the display. Release the key. Your balance is in the weighing mode and set to zero.

- 1 Press $\rightarrow 0/T \leftarrow$ to tare the balance.
- 2 Place the sample on the weighing pan.
- 3 Wait until the instability detector \circ disappears and the stability beep sounds.
- 4 Read the result.

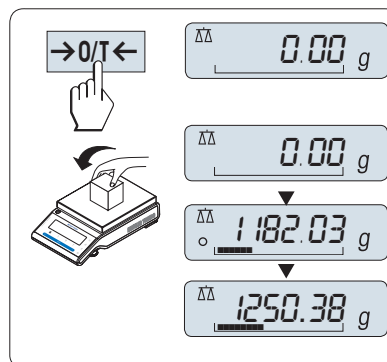

Zeroing

Use the $\rightarrow 0/T \leftarrow$ zeroing key before you start with a weighing.

- 1 Unload the balance.
- 2 Press $\rightarrow 0/T \leftarrow$ to zero the balance.
 - ➔ All weight values are measured in relation to this zero point.

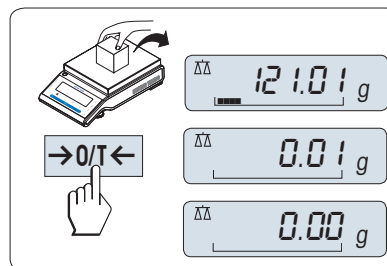

Taring

If you are working with a weighing container, first set the balance to zero.

- 1 Place empty container on the weighing pan.
 - ➔ The weight is displayed.
- 2 Press $\rightarrow 0/T \leftarrow$ to set the balance to zero.
 - ➔ **0.00 g** and **Net** appears in the display. **Net** indicates that all weight values displayed are net values.
- 3 Place weighing sample into the weighing container.
 - ➔ The result appears in the display.

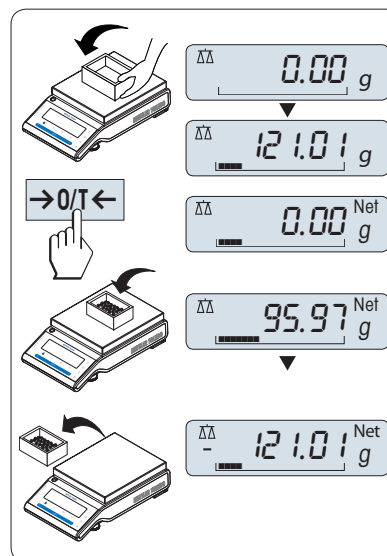

Note

- If the container is removed from the balance, the tare weight will be shown as a negative value.

- The tare weight remains stored until the **→0/T←** key is pressed again or the balance is switched off.
- With METTLER TOLEDO DeltaRange balances, the fine range with its 10 times smaller display increments (depending on the model) is available again after every taring operation.

METTLER TOLEDO DualRange balances

METTLER TOLEDO DualRange balances have two ranges. These models have a fix fine (semi-micro) range between 0 g and maximum capacity, fine range. In this fine range the balance shows the result with a higher resolution, i.e. with one decimal place more.

Switching weight units

The  key can be used at any time to toggle between weight unit **UNIT 1**, **RECALL** value (if selected) and weight unit **UNIT 2** (if different from weight unit 1) and the application unit (if any).

- Press  to set weight unit or recall value.

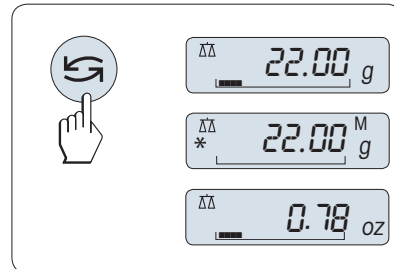

Recall / recall weight value

Recall stores stable weights with an absolute display value bigger than 10d.

- Function **RECALL** is in the menu activated.
- 1 Load weighing sample.
 - ➔ The display shows weight value and stores stable value.
 - 2 Remove weighing sample.
 - ➔ The display shows zero.
 - 3 Press .
 - ➔ The display shows last stored stable weight value for 5 seconds together with asterisk (*) and memory (M) symbols. After 5 seconds the display goes back to zero. This can be repeated unlimited times.

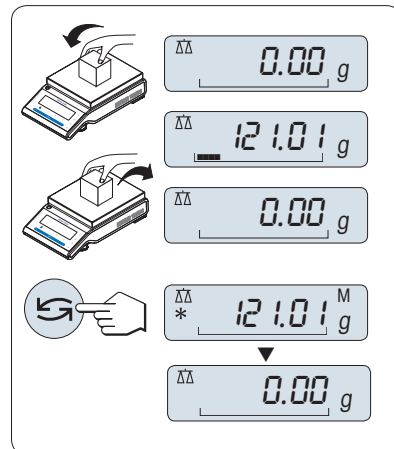

Delete last weight value

As soon a new stable weight value is displayed, the old recall value becomes replaced by the new weight value.

- Press **→0/T←**.
 - ➔ The recall value is set to 0.

If the power is switched off, the recall value is lost. The recall value can not be printed.

Weighing with the weighing-in aid

The weighing-in aid is a dynamic graphic indicator which shows the used amount of the total weighing range. You can thus recognize at a glance when the load on the balance approaches the maximum load.



Print / transmit data

Press the  key to transmit the weighing results over the interface, e.g., to a printer or a computer.

Switching off

- Press and hold the **Off** key until **SHUTOFF** appears on the display. Release the key.
- ➔ Balances switch into standby mode.
- After switching on from standby mode, your balance needs no warm-up time and is immediately ready for weighing.
- If your balance has been switched off after a preselected time, the display is dimly lit and shows date, time, maximum load and readability.
- If your balance has been switched off manually, the display is off.
- To completely switch off mains operated balances, they must be disconnected from the power supply.

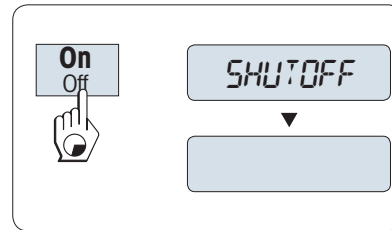

Legal-for-trade

Standby mode is not possible with approved balances (only available in selected countries).

4.9 Transporting the balance



CAUTION

Injury due to breaking glass

Careless handling with the glass components can lead to breakage of glass and damage cuttings.

- 1 Do not lift the instrument by the glass draft shield.
- 2 Always proceed focused and with care.

- 1 Press and hold the **Off** key.
- 2 Disconnect the balance from the AC/DC adapter.
- 3 Disconnect all interface cables.

4.9.1 Transporting over short distances

To move the balance over a short distance to a new location, follow the instructions below.

- 1 Hold the balance with both hands as shown.
- 2 Carefully lift the balance and carry it to its new location.

If you wish to put the balance into operation, proceed as follows:

- 1 Connect in reverse order.
- 2 Level the balance.
- 3 Perform an internal adjustment.

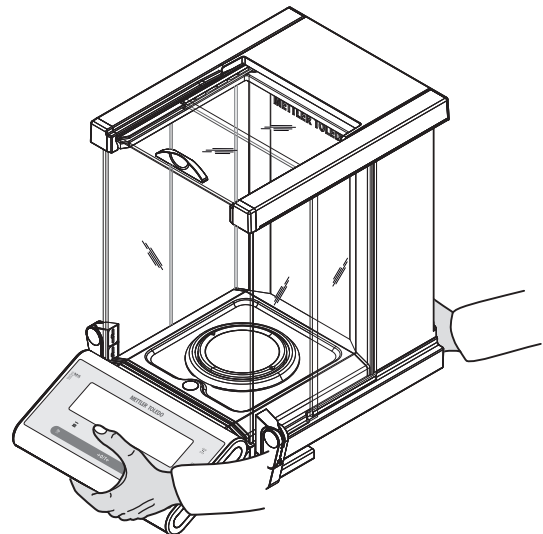

4.9.2 Transporting over long distances

To transport the balance over long distances, always use the original packaging.

4.9.3 Packaging and storage

Packing

Store all parts of the packaging in a safe place. The elements of the original packaging are developed specifically for the balance and its components to ensure maximum protection during transportation or storing.

Storing

Store the balance under following conditions:

- Indoor and in the original packaging.
- According to the environmental condition, see "Technical data".
- When storing for longer than six months, the rechargeable battery may be down (date and time get lost).

4.10 Weighing below the balance

Your balance is equipped with a weighing hook for performing weighing operations below the work surface (weighing below the balance).

- 1 Press and hold the **Off** key.
- 2 Disconnect the balance from the power supply.
- 3 Disconnect all interface cables.
- 4 Push the side doors and the top door of the glass draft shield completely to the back. **Important:** top cover must be closed.
- 5 Remove weighing pan, draft ring and drip tray.
- 6 Carefully tip the balance over backwards, until it is lying on its back.
- 7 Remove the cap (1) and retain it. The hanger (2) for weighing below the balance is easily accessible now.
- 8 Carefully turn the balance to its normal position and reinstall all components in the reverse order.

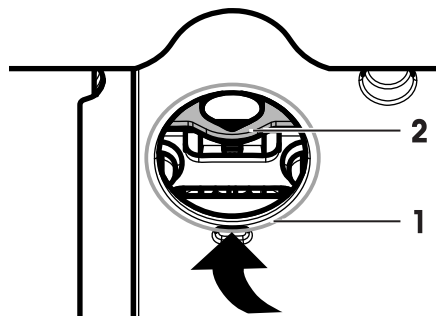

5 The Menu

5.1 What is in the menu ?



The menu allows you to match your balance to your specific weighing needs. In the menu you can change the settings of your balance and activate functions. The main menu has 4 different menus and these contains different topics, each of which allows you various selection possibilities. Menu item **PROTECT see** chapter **Description of menu topics > Main menu**.

Menu BASIC

Topic	Description
DATE	Setting the current date.
TIME	Setting the current time.
UNIT 1	Specification of the 1 st weight unit in which the balance should show the result.
UNIT 2	Specification of the 2 nd weight unit in which the balance should show the result.
KEY BEEP	Setting the key beep level.
STAB.BEEP	Setting the stability beep level.
RESET	Call up of the factory settings.

Menu ADVANCED

Topic	Description
WEIG.MODE	Adapting the balance to the weighing mode.
ENVIRON.	Matching the balance to the ambient conditions.
CAL	Settings for the type of adjustment.
ADJ.CUST.F	Executing customer fine adjustment.
FACT	Settings for fully automatic balance adjustment based on a selected time.
FACT PRT.	Switching the automatic FACT printout on or off.
DATE.FORM	Setting the date format.
TIME.FORM	Preselection of the time format.
RECALL	Switching the application recall for storing stable weights on or off.
SHUTOFF	Setting the time after which the balance should be switched off automatically.
BCKLIGHT	Setting the time after which the display backlight should be switched off automatically.
DISPLAY	Adjusting the brightness and contrast of the display.
AUTOZERO	Switching the automatic zero correction (Autozero) on or off.
ZERO RNG	Setting the zero limit of the zero/tare key.
LANGUAGE	Setting the preferred language.
ASSIGN:F1	Selection of assigned F1 key application and entering their parameter settings.
ASSIGN:F2	Selection of assigned F2 key application and entering their parameter settings.
ASSIGN:F3	Selection of assigned F3 key application and entering their parameter settings.
DIAGNOSE	Starting a diagnostic application.
SERV.ICON	Switching the service icon (service reminder) on or off.
SRV.D.RST	Reset service date and hours (service reminder).



Menu INT.FACE

Topic	Description
RS232	Matching the serial interface RS232C to a peripheral unit.
HEADER	Setting the header for printout of individual values.
SINGLE	Setting the information for printout of individual values.
SIGN.L	Setting the footer for printout of individual values.
LINE.FEED	Setting line feed for printout of individual values.
ZERO PRT.	Setting the auto print function for printing zero.
COM.SET	Setting the data communication format of the serial interface RS232C.
BAUDRATE	Setting the transfer speed of the serial interface RS232C.
BIT/PAR.	Setting the character format (Bit/Parity) of the serial interface RS232C.
STOPBIT	Setting the character format (stop bit) of the serial interface RS232C.
HD.SHAKE	Setting the transfer protocol (Handshake) of the serial interface RS232C.
RS.TX.E.O.L.	Setting the end of line format of the serial interface RS232C (outgoing data).
RS CHAR	Setting the char set of the serial interface RS232C.
USB	Matching the USB interface to a peripheral unit.
USB COM.S.	Setting the data communication format of the USB interface.
USB E.O.L.	Setting the end of line format of the USB interface.
USB CHAR	Setting the char set of the USB interface.
INTERVAL	Selection of the time interval for the simulated print key press.
ERGOSENS	Settings for external key e.g. METTLER TOLEDO ErgoSens

5.2 Menu operation

In this section you will learn how to work with the menu.

Select menu

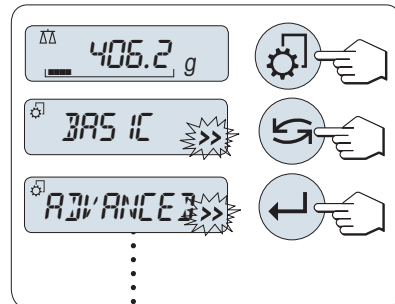

- 1 Press  to activate main menu.
 - ➔ The first menu **BASIC** is displayed (except menu protection is active).
- 2 Press  repeatedly to change menu (Scrolling down/up + / - keys).
- 3 Press  to confirm the selection.



Note

The menu selection **BASIC**, **ADVANCED** or **INT.FACE** can not be saved. The selection **PROTECT** must be saved.

Select menu topic

- 1 Press .
 - ➔ The next menu topic appears in the display.
- 2 Press  or the + key.
 - ➔ The balance switches to the next menu topic.
- 3 Press - key to return to the previous menu topic.

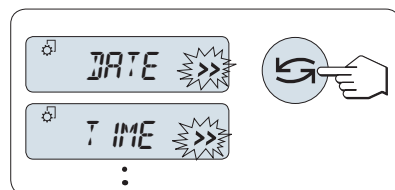

Change settings in a selected menu topic

The >> flashing symbol in the display indicates selectable options available.

- 1 Press .
➔ The display shows the current setting in the selected menu topic.
- 2 Press or the + key, the balance switches to the next selection.
- 3 Press – key to return to the previous selection.
➔ After the last selection, the first is shown again.
- 4 Press to confirm the setting.

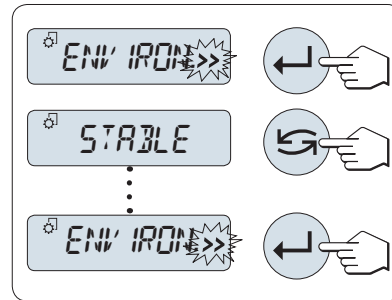

For store the setting, **see** section "Saving settings and closing the menu".

Change settings in a submenu selection

The same procedure as for menu topics.

Input principle of numerical values

- 1 Press for input of numerical values.
- 2 Press to select a digit or a value (depending on the application).
➔ The selected digit or the selected value is blinking.
- 3 Press + to scroll up or – to scroll down for changing digits or values.
- 4 Press to confirm the input.

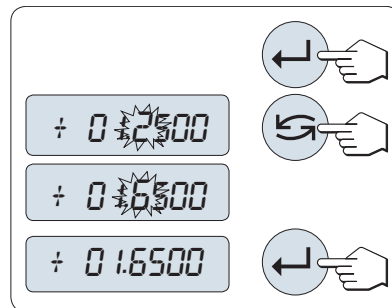

Saving settings and closing the menu

- 1 Press briefly to leave menu topic.
- 2 Press to execute **SAVE:YES**.
➔ Changes are saved.
- 3 Press to execute **SAVE:NO**.
➔ Changes are not saved.
- 4 Press to toggle between **SAVE:YES** and **SAVE:NO**.

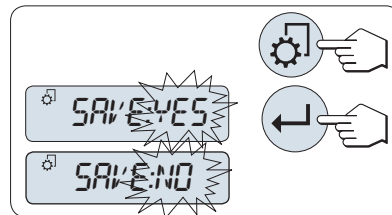

Cancel

- Press **C** for leaving menu topic or menu selection without saving.



Note

If no entry is made within 30 seconds, the balance reverts to last active application mode. Changes are not saved. If changes are made, the balance asks **SAVE:NO**.

5.3 Description of menu topic

In this section you will find information regarding the individual menu topics and the available selections.

5.3.1 Main menu

Selecting the menu.

BASIC

The small **BASIC** menu for simple weighing is displayed.

ADVANCED	The extended ADVANCED menu for further weighing settings is displayed.
INT.FACE	The menu INT.FACE for all interface parameter settings for peripheral devices, e.g., printer is displayed.
PROTECT	Menu protection. Protection of balance configurations against unmeant manipulation.
OFF	Menu protection is off. (Factory setting)
ON	Menu protection is on. The menu BASIC , ADVANCED and INT.FACE are not displayed. This is indicated with Ⓛ in the display.

 **Note**

- The menu selection **BASIC**, **ADVANCED** or **INT.FACE** can not be saved.
- To activate **PROTECT ON** or **OFF**, this selection must be saved.

5.3.2 Basic menu

DATE – Date

Setting the current date according to date format.

 **Note**

A reset of the balance will not change this setting.

TIME – Time

Setting the current time according to time format

+1H	Set the current time forwards by 1 hour (to adjust summer or winter time). (Factory setting)
-1H	Set the current time backwards by 1 hour (to adjust summer or winter time).
SET TIME	Enter the current time.

 **Note**

A reset of the balance will not change this setting.

UNIT 1 – Weight unit 1

Depending on requirements, the balance can operate with the following units (depending on the model)

Legal-for-trade

- Only those weight units allowed by the appropriate national legislation are selectable.
- With approved balances, this menu topic has a fixed setting and cannot be changed.

Units:

g ¹⁾	Gram	dwt	Pennyweight
kg ²⁾	Kilogram	mom	Momme
mg ³⁾	Milligram	msg	Mesghal
ct	Carat	tlh	Tael Hong Kong
lb	Pound	tls ⁴⁾	Tael Singapore
oz	Ounce (avdp)	tlt	Tael Taiwan
ozt	Ounce (troy)	tola	Tola
GN	Grain	baht	Baht

- 1) factory setting
- 2) not with 0.01 mg, 0.1 mg and 1 mg balances
- 3) with 0.01 mg, 0.1 mg and 1 mg balances
- 4) the Malaysian tael has the same value

UNIT 2 – Weight unit 2

If it is required to show the weighing results in weighing mode in an additional unit, the desired second weight unit can be selected in this menu topic (depending on the model). Units see **UNIT 1**. Select **NO**, if you do not want to use **UNIT 2**.

Legal-for-trade

Only those weight units allowed by the appropriate national legislation are selectable.

KEY BEEP – Key beep

This menu topic allows you to select the volume of the key beep. The according key beep is emitted during the setting.

MED	Medium level (Factory setting)
HIGH	High level
OFF	Beep switched off
LOW	Low level

STAB.BEEP – Stability beep

If the unstable symbol disappears, the stability beep becomes active. This menu topic allows you to preselect the volume of the stability beep.

MED	Medium level (Factory setting)
HIGH	High level
OFF	Beep switched off
LOW	Low level

RESET – Reset balance settings

This menu topic allows you to call-up the factory settings.

To toggle between **YES?** and **NO?** press  (or + or -).



Note

A reset of the balance will not change the **DATE**, **TIME** and **ZERO RNG** settings.

5.3.3 Advanced menu

WEIG.MODE – Weighing mode settings

This setting can be used to adapt the balance to the weighing mode.

UNIVERS.	For all standard weighing applications. (Factory setting)
DOSING	For dosing liquid or powdery products. With this setting, the balance responds very quickly to the smallest changes in weight.

ENVIRON. – Environment settings

This setting can be used to match your balance to the ambient conditions.

STANDARD	Setting for an average working environment subject to moderate variations in the ambient conditions. (Factory setting)
UNSTABLE	Setting for a working environment where the conditions are continuously changing.
STABLE	Setting for a working environment which is practically free from drafts and vibrations.

CAL – Adjustment

In this menu topic you can preselect the function of the \square key. Your balance can be adjusted with internal or external weights by pressing the \square key. If you have attached a printer to your balance, the data of the adjustment are printed out.

ADJ.OFF	The adjustment is switched off . The \square key has no function.
ADJ.INT	Internal adjustment: adjustment is performed at a keystroke with the built-in weight (depending on the model, see technical data).
ADJ.EXT	External adjustment: adjustment is performed at a keystroke with a selectable external weight.
100.00 g	Defining the external adjustment weight: define the weight of the external adjustment weight (in grams). Factory setting: depends on the model.

ADJ.CUST.F – Customer fine adjustment

At this menu topic you can fine-adjust the internal weights. Further information refer to chapter **Customer fine adjustment**.

EXECUTE	Start customer fine adjustment ADJ.CUST.F .
RESET	Deactivate customer fine adjustment after confirming with YES? .
NO?	No deactivation.
YES?	Confirm to deactivation.

FACT – Fully automatic adjustment

FACT provides fully automatic balance adjustment based on temperature criteria and on preselected time.

TIME	Execute FACT (with selected time).
12:00	Specify the time for a fully automatic adjustment to take place every day. Factory setting: 12:00 (according to time format)
OFF	FACT is switched off .

FACT PRT. – Protocol trigger for FACT

This setting specifies whether an adjustment report should be printed automatically.

Note: This menu topic does not affect the printing of adjustments with an internal or external adjustment weight.

OFF	Protocol switched off: If the balance is adjusted automatically (FACT), a protocol is not printed out.
ON	Protocol switched on: A record is printed out after every automatic adjustment of the balance (FACT). Note: The protocol is printed out without a line for signatures.

DATE.FORM – Date format

This menu topic allows you to preselect the date format.

The following date formats are available:

	Display examples	Printing examples
DD.MM.Y	01.02.2009	01.02.2009
MM/DD/Y	02/01/09	02/01/2009
Y-MM-DD	09-02-01	2009-02-01
D.MMM Y	1.FEB.09	1.FEB 2009
MMM D Y	FEB.1.09	FEB 1 2009

Factory setting: DD.MM.Y

TIME.FORM – Time format

This menu topic allows you to preselect the time format.

The following date formats are available:

	Display examples
24:MM	15:04
12:MM	3:04 PM
24.MM	15.04
12.MM	3.04 PM

Factory setting: 24:MM

RECALL – Recall

This menu topic allows you to switch the **RECALL** function on or off. When it is switched on recall stores the last stable weight if the absolute display value was bigger than 10d.

OFF	RECALL switched off (Factory setting)
ON	RECALL switched on

 **Note:** the recall value is displayed with an asterisk and cannot be printed.

SHUTOFF – Automatic shutoff

If the automatic shutoff function is activated, the balance automatically switches itself off after a preselected time of inactivity (i.e., with no key being pressed or changes of weight occurring etc.) and is switched to the standby mode.

A.OFF 10 min	Automatic shutoff after 10 minutes of inactivity. (Factory setting)
A.OFF –	Automatic shutoff not activated.
A.OFF 2 min	Automatic shutoff after 2 minutes of inactivity.
A.OFF 5 min	Automatic shutoff after 5 minutes of inactivity.

BCKLIGHT – Backlight

Under this menu topic, the display backlight can be switched off automatically. If the automatic switch-off is activated, the backlight will turn off automatically after the selected period of inactivity has elapsed. The backlight is reactivated when a key is pressed or the weight is changed.

B.L. ON	Backlight is always on . (Factory setting)
B.L. 30 s	Automatic switch-off after 30 seconds inactivity.
B.L. 1 min	Automatic switch-off after 1 minute inactivity.
B.L. 2 min	Automatic switch-off after 2 minutes inactivity.
B.L. 5 min	Automatic switch-off after 5 minutes inactivity.

DISPLAY – Display settings

This menu topic allows you to adjust brightness and contrast of the display.

BRIGHTN	To set the brightness in 1% steps.
50%	Factory setting: 50%
CONTRAST	To set the contrast in 1% steps.
75%	Factory setting: 75%

AUTOZERO – Automatic zero setting

This menu topic allows you to switch the automatic zero setting on or off.

ON	AUTOZERO switched on (Factory setting). The automatic zero setting continuously corrects possible variations in the zero point that might be caused through small amounts of contamination on the weighing pan.
OFF	AUTOZERO switched off. The zero point is not automatically corrected. This setting is advantageous for special applications, e.g., evaporation measurements.

Legal-for-trade

With approved balances, this setting is not available in selected countries.

ZERO RNG – Zero range

This menu topic allows you to set a zero limit for the $\rightarrow 0/T \leftarrow$ key. Up to and including this limit the $\rightarrow 0/T \leftarrow$ key will execute a zero. Above this limit the $\rightarrow 0/T \leftarrow$ key will execute a tare.

1.2 g	To set the upper limit of the zero setting range as weight in the definition unit of the balance. (Factory setting: 0.5% of weighing range)  Note: with approved balances, this setting is not available and fixed to 3e (only available in selected countries).
--------------	--



Note

A reset of the balance will not change this setting.

LANGUAGE – Language

Factory setting: generally, the language of the destination country (if available) or English is set.

The following languages are available:

ENGLISH	English	POLSKI	Polish
DEUTSCH	German	CESKY	Czech
FRANCAIS	French	MAGYAR	Hungarian
ESPAÑOL	Spanish	NEDERL.	Dutch
ITALIANO	Italian	BR.PORTUG.	Brazil Portuguese
RUSSIAN РУССКИЙ	Russian		

ASSIGN:F1 – Assign application key F1

At this menu topic you can assign an application to the **F1** key. The following applications are available (depending on the model):

COUNTING	Piece counting (Factory setting)
PERCENT	Percent weighing
STAT	Statistics
FORMULA	Formulation / Net total
TOTALING	Totaling
FACTOR M	Multiplication factor
FACTOR D	Division factor
DENSITY	Density
PIPETTE	Pipette check

ASSIGN:F2 – Assign application key F2

At this menu topic you can assign an application to the **F2** key. The following applications are available (depending on the model):

PERCENT	Percent weighing (Factory setting)
STAT	Statistics
FORMULA	Formulation / Net total
TOTALING	Totaling
FACTOR M	Multiplication factor
FACTOR D	Division factor
DENSITY	Density
PIPETTE	Pipette check
COUNTING	Piece counting

ASSIGN:F3 – Assign application key F3

At this menu topic you can assign an application to the **F3** key. The following applications are available (depending on the model):

STAT	Statistics (Factory setting)
FORMULA	Formulation / Net total
TOTALING	Totaling
FACTOR M	Multiplication factor
FACTOR D	Division factor
DENSITY	Density
PIPETTE	Pipette check
R. TEST	Routine test
COUNTING	Piece counting
PERCENT	Percent weighing

DIAGNOSE – Diagnostics application



At this menu topic you can start a diagnostic application. For more information **see** chapter **Application diagnostics**.

The following diagnostics are available:

REPEAT.T	Repeatability test (models with internal weights only)
DISPLAY	Display test
KEYPAD T	Key test
CAL.MOT. T	Motor test (models with internal weights only)
BAL.HIST	Balance history
CAL.HIST	Calibration history
BAL.INFO	Balance information
PROVIDER	Service provider information

SERV.ICON – Service reminder

This menu topic allows you to switch the service reminder  on or off.

ON	Service reminder  switched on (factory setting). You will be informed after a preset time (e.g. one year or 8000 operating hours) to call service for recalibration. This will be indicated by the flashing service icon:  . (Factory setting)
OFF	Service reminder  switched off .

SRV.D.RST – Service date reset

This menu topic allows you to reset service date and hours.



Note

This menu topic is only available if **SERV.ICON** setting **ON** was selected.

To toggle between **YES?** and **NO?** press (or + or -).

RS CHAR – Char set RS232C ¹⁾

At this menu topic you can set the character set of the transmitted data to different RS232C serial receivers.

IBM/DOS	Char set IBM/DOS (Factory setting)
ANSI/WIN	Char set ANSI/WINDOWS



Note

- Not visible for 2nd display.
- Each device has separate settings.

5.3.4 Interface menu

RS232 – RS232C interface ¹⁾

At this menu topic you can select the peripheral device connected to the RS232C interface and specify how the data is transmitted.

PRINTER	Connection to a printer. (Factory setting) Only one printer possible. Refer to your printer documentation for recommended printer settings.
PRT.STAB	If the key is pressed, the next stable weight value will be printed. (Factory setting)
PRT.AUTO	Every stable weight value will be printed, without pressing the key.
PRT.ALL	If the key is pressed, the weight value will be printed regardless of stability.
PC-DIR.	Connection to a PC: the balance can send data (as a keyboard) to the PC used for PC applications, e.g., Excel. The balance sends the weight value without the unit to the PC.
PRT.STAB	If the key is pressed, the next stable weight value will be sent followed by an enter. (Factory setting)
PRT.AUTO	Every stable weight value will be sent followed by an enter, without pressing the key.
PRT.ALL	If the key is pressed, the weight value will be sent followed by an enter regardless of stability.
HOST	Connection to a PC, barcode reader etc.: the balance can send data to the PC and receive commands or data from the PC).
SEND.OFF	Send mode switched off. (Factory setting)
SEND.STB	If the key is pressed, the next stable weight value will be sent.
SEND.CONT	All weight value updates will be sent regardless of stability, without pressing the key.
SEND.AUTO	Every stable weight value will be sent, without pressing the key.
SEND.ALL	If the key is pressed, the weight value will be sent regardless of stability.

2.DISPLAY

Connection of an optional auxiliary display unit. The transmission parameters cannot be selected. Settings are automatically set.



NOTICE

Damage to the device due voltage on connector

Devices could be damaged because of the voltage on connector Pin 9.

- Make sure that no other device is connected at COM1 as a 2nd display.



Note

If you select 2nd display **2.DISPLAY**, first make sure that no other device is connected at COM1 as a 2nd display. Necessary for powering the 2nd display, **see** chapter "Interface specification".

HEADER – Options for the printout header of individual values

This menu topic allows you to specify the information that is to be printed at the top of the printout for every individual weighing results (after pressing).



Note

This menu topic is only available if **PRINTER** setting was selected.

NO	The header is not be printed. (Factory setting)
DAT / TIM	Date and time are printed.
D / T / BAL	Date, time and balance information (Balance type, SNR, Balance ID) are printed. Balance ID only if set.

SINGLE – Options for printing out the result of individual values

This menu topic allows you to specify the information that is to be printed for every individual weighing result (after pressing .

Note: this menu topic is only available if **PRINTER** setting was selected.

NET	The value of the net weight from the current weighing is printed. (Factory setting)
G / T / N	The values of the gross weight, the tare weight and the net weight are printed.

SIGN.L – Options for the printout footer for signature line of individual values

This menu topic allows you to set a footer for signature at the bottom of the printout for every individual weighing result (after pressing .

Note: this menu topic is only available if **PRINTER** setting was selected.

OFF	The signature footer is not be printed. (Factory setting)
ON	The signature footer is printed.

LINE.FEED – Options for complete the printout of individual values

This menu topic allows you to specify the number of blank lines to complete the printout (line feed) for every individual weighing result (after pressing .

Note: this menu topic is only available if **PRINTER** setting was selected.

0	Possible numbers of blank lines: 0 to 99. (Factory setting = 0)
----------	--

ZERO PRT. – Options for PRT.AUTO ¹⁾

This menu topic allows you to specify the auto print function **PRT.AUTO** for printing zero **YES** or **NO**.

OFF	Zero is not be printed (Zero +/- 3d). (Factory setting)
ON	Zero is always printed.

 **Note:** this menu topic is only available if **PRT.AUTO** function of the **PRINTER** or **PC-DIR.** was selected.

COM.SET – Options for the data communication format (RS232C) (HOST) ¹⁾

This menu topic allows you to set the data format depending on which peripheral device is connected.

Note

This menu topic is only available if **HOST** setting was selected.

MT-SICS The MT-SICS data transfer formats is used. (**Factory setting**)
For more information, see "MT-SICS interface commands and functions".

MT-PM The following PM balance commands are supported:

S	Send value
SI	Send immediate value
SIR	Send immediate value and repeat
SR	Send value and repeat
SNR	Send next value and repeat
T	Tare
TI	Tare immediately
B	Base *)
MI	Modify ambient vibration
MZ	Modify auto zero
M	Modified settings reset
ID	Identify
CA	Calibrate
D	Display (only symbol N and G available)

*) Limitation:

- Negative values are limited up to the current tare value.
- B command is additive.
- The sum of the B values plus the previous tare value, before a "TA", "T" or "Z" is sent, must be less than the total weighing range.

SART The following Sartorius commands are supported:

K	Ambient conditions: very stable
L	Ambient conditions: stable
M	Ambient conditions: unstable
N	Ambient conditions: very unstable
O	Block keys
P	Print key (print, auto print; activate or block)
Q	Acoustic signal
R	Unblock keys

S	Restart/self-test
T	Tare key
W	Calibration/adjustment (depending on the menu setting ^{*)}
Z	Internal calibration/adjustment ^{**)}
f0_	Function key (F)
f1_	Function key (CAL)
s3_	C key
x0_	Perform internal calibration ^{**)}
x1_	Print balance/scale model
x2_	Print weighing cell serial number
x3_	Print software version

^{*)} may be inaccessible on verified balances/scales

^{**)} only on models with built-in motorized calibration weight

Functionality mapping

HOST settings:	Sartorius printer settings:
SEND.OFF	not applicable
SEND.STB	manually print with stability
SEND.ALL	manually print without stability
SEND.CONT	automatically print without stability
SEND.AUTO	similar applicable to automatically print when load is changed

BAUDRATE – Baud rate RS232C ¹⁾

This menu topic allows you to match the data transmission to different serial RS232C receivers. The baud rate (data transfer rate) determines the speed of transmission via the serial interface. For problem-free data transmission the sending and receiving devices must be set at the same value.

The following settings are available:

600 bd, 1200 bd, 2400 bd, 4800 bd, 9600 bd, 19200 and 38400 bd. (default: **9600 bd**)



Note

- Not visible for 2nd display.
- Each device has separate settings.

BIT/PAR. – Bit/Parity RS232C ¹⁾

At this menu topic you can set the character format for the attached RS232C serial peripheral device.

8/NO	8 data bits/no parity (Factory setting)
7/NO	7 data bits/no parity
7/MARK	7 data bits/mark parity
7/SPACE	7 data bits/space parity
7/EVEN	7 data bits/even parity
7/ODD	7 data bits/odd parity



Note

- Not visible for 2nd display.
- Each device has separate settings.

STOPBIT – Stop bits RS232C ¹⁾

At this menu topic you can set the stop bits of the transmitted data to different RS232C serial receivers.

1 BIT	1 Stop bit (Factory setting)
2 BITS	2 Stop bits

Note

- Not visible for 2nd display.
- Each device has separate settings.

HD.SHAKE – Handshake RS232C ¹⁾

This menu topic allows you to match the data transmission to different RS232C serial receivers.

XON/XOFF	Software handshake (XON/XOFF) (Factory setting)
RTS/CTS	Hardware handshake (RTS/CTS)
OFF	No handshake

Note

- Not visible for 2nd display.
- Each device has separate settings.

RS.TX.E.O.L. – End of line RS232C ¹⁾

At this menu topic you can set the end of line character of the transmitted outgoing data to different RS232C serial receivers.

(CR)(LF)	<CR><LF> Carriage Return followed by Line feed (ASCII-Codes 013 + 010) (Factory setting)
(CR)	<CR> Carriage Return (ASCII-Code 013)
(LF)	<LF> Line feed (ASCII-Code 010)
(TAB)	<TAB> Tabulator to the right (ASCII-Code 009), only settable if PC-DIR. is selected.

Note

- Not visible for 2nd display.
- Each device has separate settings.

RS CHAR – Char set RS232C ¹⁾

At this menu topic you can set the character set of the transmitted data to different RS232C serial receivers.

IBM/DOS	Char set IBM/DOS (Factory setting)
ANSI/WIN	Char set ANSI/WINDOWS

Note

- Not visible for 2nd display.
- Each device has separate settings.

USB – USB interface

At this menu topic you can select the mode of the USB device interface and specify how the data is transmitted.











NOTICE

Disconnect the USB connection from the balance prior to changing settings.

Note

- This port is not usable for printers or displays.

PC-DIR.	Connection to a PC: the balance can send data (as a keyboard) to the PC used for PC applications, e.g., Excel. Note: the balance sends the weight value without the unit to the PC.
SEND.OFF	Send mode switched off. (Factory setting)
SEND.STB	If the  key is pressed, the next stable weight value will be sent.
SEND.CONT	All weight value updates will be sent regardless of stability, without pressing the  key.
SEND.AUTO	Every stable weight value will be sent, without pressing the  key.
SEND.ALL	If the  key is pressed, the weight value will be sent regardless of stability.
HOST	Connection to a PC, Barcode Reader etc.: the balance can send data to the PC and receive commands or data from the PC).
SEND.OFF	Send mode switched off. (Factory setting)
SEND.STB	If the  key is pressed, the next stable weight value will be sent.
SEND.CONT	All weight value updates will be sent regardless of stability, without pressing the  key.
SEND.AUTO	Every stable weight value will be sent, without pressing the  key.
SEND.ALL	If the  key is pressed, the weight value will be sent regardless of stability.

USB COM.S. – Options for the data communication format (USB)

This menu topic allows you to set the data format depending on which peripheral device is connected.

MT-SICS	The MT-SICS data transfer formats is used. (Factory setting) For more information, see "MT-SICS interface commands and functions".
MT-PM	The following PM balance commands are supported: S Send value SI Send immediate value SIR Send immediate value and repeat SR Send value and repeat SNR Send next value and repeat T Tare TI Tare immediately B Base *) MI Modify ambient vibration MZ Modify auto zero M Modified settings reset ID Identify CA Calibrate D Display (only symbol N and G available)

*) Limitation:

- Negative values are limited up to the current tare value.
- B command is additive.
- The sum of the B values plus the previous tare value, before a "TA", "T" or "Z" is sent, must be less than the total weighing range.

SART

The following Sartorius commands are supported:

K	Ambient conditions: very stable
L	Ambient conditions: stable
M	Ambient conditions: unstable
N	Ambient conditions: very unstable
O	Block keys
P	Print key (print, auto print; activate or block)
Q	Acoustic signal
R	Unblock keys
S	Restart/self-test
T	Tare key
W	Calibration/adjustment (depending on the menu setting) *)
Z	Internal calibration/adjustment **)
f0_	Function key (F)
f1_	Function key (CAL)
s3_	C key
x0_	Perform internal calibration **)
x1_	Print balance/scale model
x2_	Print weighing cell serial number
x3_	Print software version

*) may be inaccessible on verified balances/scales

**) only on models with built-in motorized calibration weight

Functionality mapping

HOST settings:	Sartorius printer settings:
SEND.OFF	not applicable
SEND.STB	manually print with stability
SEND.ALL	manually print without stability
SEND.CONT	automatically print without stability
SEND.AUTO	similar applicable to automatically print when load is changed

USB E.O.L. – End of line USB

At this menu topic you can set the end of line character of the transmitted data to USB device.

(CR)(LF)	<CR><LF> Carriage Return followed by Line feed (ASCII-Codes 013 + 010) (Factory setting)
(CR)	<CR> Carriage Return (ASCII-Code 013)
(LF)	<LF> Line feed (ASCII-Code 010)

(TAB)

<TAB> Horizontal tab (ASCII-Code 011), only settable if **PC-DIR.** is selected.

USB CHAR – Char set USB

At this menu topic you can set the character set of the transmitted data to USB device.

ANSI/WIN

Char set ANSI/WINDOWS (**Factory setting**)

IBM/DOS

Char set IBM/DOS

INTERVAL – Print key simulation

At this menu topic you can activate a simulation of the  key. **INTERVAL** simulates a print key press every x seconds.

Range:

0 to 65535 seconds

0 sec:

disables the print key simulation

Factory setting: 0 sec

 **Note:** the executed action is according to the configuration of the print key, see interface setting.

ERGOSENS – Settings for external key

The METTLER TOLEDO **ErgoSens** or external contact switches (optional, see section accessories) can be connected to the "Aux" connection and these can be used to execute certain weighing functions.

OFF

Deactivate (**Factory setting**)

->0<-

Zero setting

->T<-

Taring

PRINT

Print 

1) Note for 2nd RS232C interface

- If an optional 2nd interface is installed, the menu topic is displayed for each interface, e.g
BAUDRATE.1 for standard interface
BAUDRATE.2 for optional 2nd interface
 - Only one printer can be set if two RS232 interfaces are existing.
-

6 Applications

6.1 Application piece counting

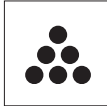

The **Piece counting** application allows you to determine the number of pieces put on the weighing pan.

Requirement: the function **COUNTING** must be assigned to an **Fx** key. **See** advanced menu topic **ASSIGN:Fx**, **factory setting:** F1.

- Press and hold the appropriate assigned **Fx** key to activate the function **COUNTING**.



Piece counting first requires the setting of a reference weight, there are 4 possibilities

- **A** Setting the reference **by multiple pieces with fix reference values**.
- **B** Setting the reference **by multiple pieces with variable reference values**.
- **C** Setting the reference **for 1 piece in weighing mode**.
- **D** Setting the reference **for 1 piece in manual mode**.

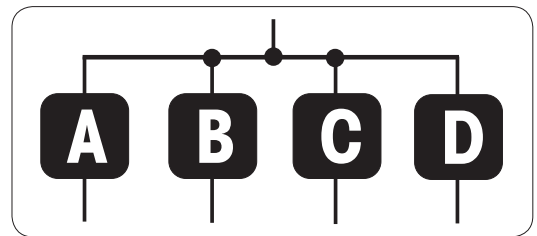

Setting the reference by multiple pieces with fix reference values

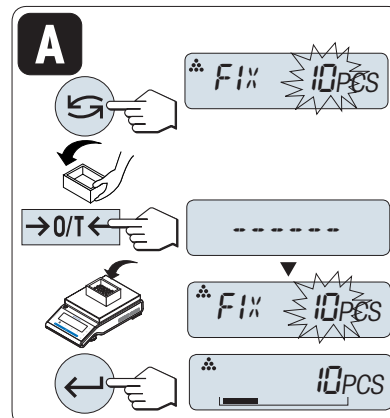

- 1 Select a number of reference pieces by scrolling with . Possible numbers* are 5, 10, 20 and 50.
- 2 Press $\rightarrow 0/T \leftarrow$ to zero the balance. If using: place empty container on the weighing pan and press $\rightarrow 0/T \leftarrow$ to tare the balance.
- 3 Add the selected number of reference pieces to container.
- 4 Press \leftarrow to confirm.



Legal-for-trade

* with approved balances in selected countries: min 10.

Setting the reference by multiple pieces with variable reference values

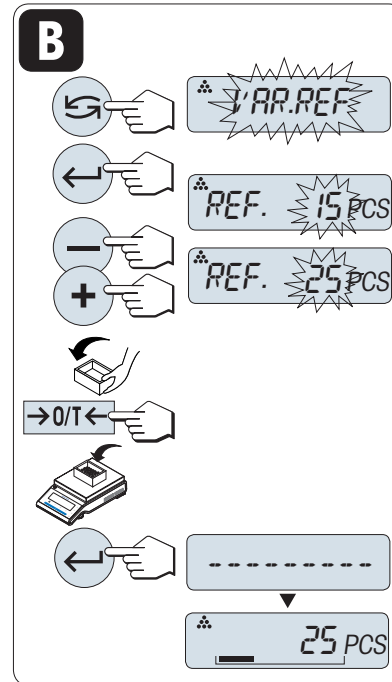

- 1 Select **VAR.REF** by scrolling with .
- 2 Press  to confirm.
- 3 Select a number of reference pieces by scrolling up **+** key or down **-** key. Speed up by press and hold. Possible numbers* are 1 to 999.
- 4 Press **→0/T←** to zero the balance. If using: place empty container on the weighing pan and press **→0/T←** to tare the balance.
- 5 Add the selected number of reference pieces to container.
- 6 Press  to confirm.



Legal-for-trade

* with approved balances in selected countries: min 10.

Setting the reference for one piece in weighing mode

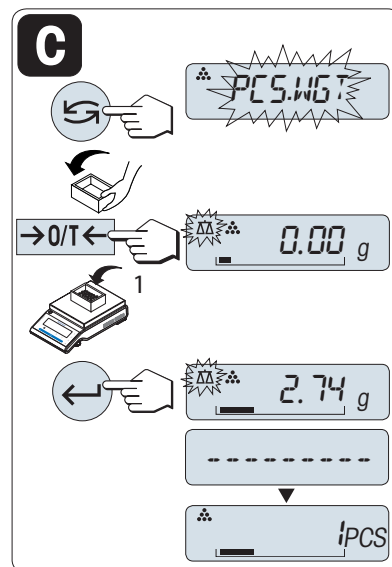

- 1 Select **PCS.WGT** by scrolling with .
- 2 Press **→0/T←** to zero the balance. If using: place empty container on the weighing pan and press **→0/T←** to tare the balance.
- 3 Add one reference piece to container.
 - ➔ The weight of one piece is displayed.
- 4 Press  to confirm.



Legal-for-trade

With approved balances, this setting is not available in selected countries.

Setting the reference for one piece in manual mode

- 1 Select **PCS.WGT** by scrolling with .
- 2 Press  to confirm.
- 3 Enter the final reference one piece weight by scrolling up **+** key or down **-** key. Speed up by press and hold.
- 4 Press  to confirm.

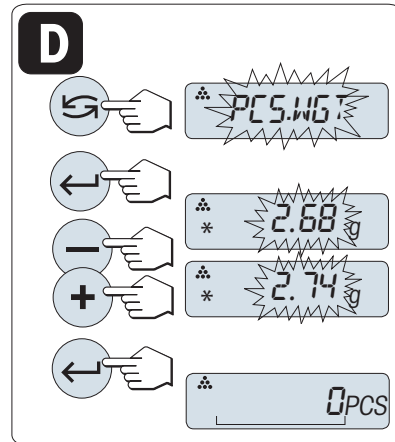

Legal-for-trade

With approved balances, this setting is not available in selected countries.

Switching between manual mode and weighing mode

- Press  to switch between manual and weighing mode.
- ➔ By switching from weighing mode to manual mode the weight value will be transferred and can be changed manually.

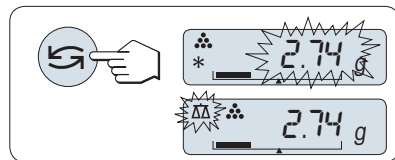

Note

If without any key press within 60 seconds or by pressing **C**, the balance returns to the previous active application.

On completion of the setting procedure, your balance is ready.

Switching between piece count and weight display

- Press  key at any time to switch the display between piece display, weighing unit **UNIT 1**, **RECALL** value (if activated) and weighing unit **UNIT 2** (if different from **UNIT 1**).
- The **RECALL** value is displayed with an asterisk (*) and icon **M** and can not be printed.
- Take into account minimum values: min. reference weight = 10d (10 digits), min. piece weight* = 1d (1 digit)!
* with approved balances in selected countries: min 3e
- The current reference weight remains stored until the reference setting is changed.

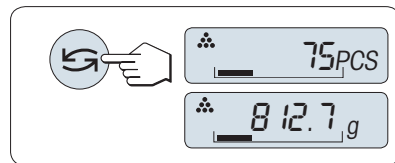

Terminate the application

Press and hold  to terminate the application and to return to the weighing application.

6.2 Application percent weighing



The **Percent weighing** application allows you to check a sample weight as percentage to a reference target weight.

Requirement: the function **PERCENT** must be assigned to an **Fx** key. **See** advanced menu topic **ASSIGN:Fx**, **factory setting:** F2.

- Press and hold the appropriate assigned **Fx** key to activate the function **PERCENT**.



Percent weighing first requires the setting of a reference weight that should corresponds to 100%, there are 2 possibilities

- **A** Setting the reference **in manual mode (enter 100%)**.
- **B** Setting the reference **in weighing mode (weigh 100%)**.

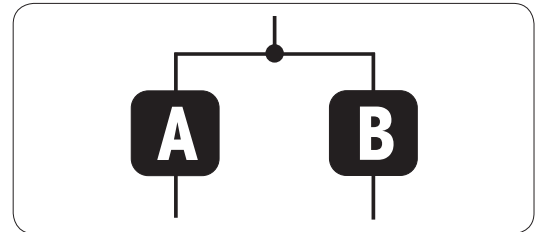

Setting the reference by manual mode (enter 100%)

- 1 Press \leftarrow to activate manual mode.
- 2 Select the reference target weight (100%) by scrolling up + key or down – key. Speed up by press and hold.
- 3 Press \leftarrow to confirm.

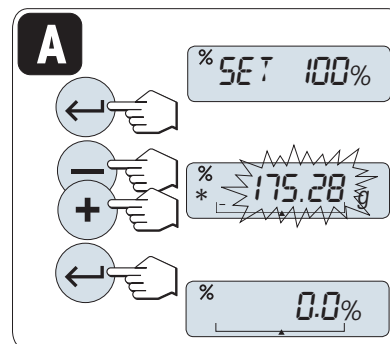

Setting the reference by weighing mode (weigh 100%)

- 1 Press $\rightarrow 0/T \leftarrow$ to zero the balance. If using: place empty container on the weighing pan and press $\rightarrow 0/T \leftarrow$ to tare the balance.
- 2 Load the reference weight (100%). Reference weight must be at least +/- 10d.
- 3 Press \leftarrow to confirm.

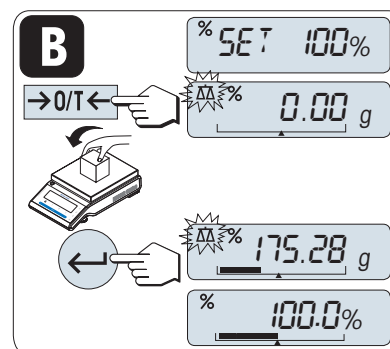

Switching between manual mode and weighing mode

- Press  to switch between manual and weighing mode.
- ➔ By switching from weighing mode to manual mode the weight value will be transferred and can be changed manually.

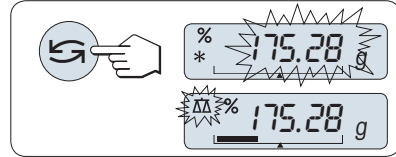

Note

If without any key press within 60 seconds or by pressing **C**, the balance returns to the previous active application.

On completion of the setting procedure, your balance is ready.

Switching between percent and weight display

- Press  key at any time to switch the display between percent display, weighing unit **UNIT 1**, **RECALL** value (if activated) and weighing unit **UNIT 2** (if different from **UNIT 1**).
- The **RECALL** value is displayed with an asterisk (*) and icon **M** and can not be printed.
- The current set weight remains stored until it is redetermined.

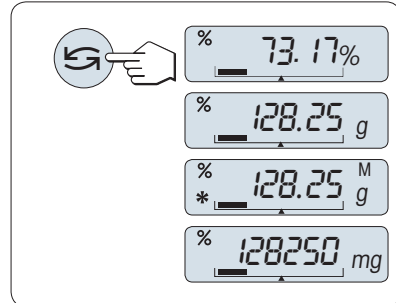

Terminate the application

Press and hold  to terminate the application and to return to the weighing application.

6.3 Application statistics



The **Statistics** application allows you to generate statistics of a series of weighing values. 1 to 999 values are possible.

Requirement: the function **STAT** must be assigned to an **Fx** key. **See** advanced menu topic **ASSIGN:Fx**. Connect a printer or a PC if present.

- 1 Press and hold the appropriate assigned **Fx** key to activate the function **STAT**.
- 2 Press \leftarrow to continue the last statistics.
- 3 Press \rightarrow to start a new statistical evaluation.
- 4 Press \leftarrow and select **Yes** to clear the memory.

If the memory is already cleared (at the first start of this application or sample counter is 0) the memory clear question will be not displayed.

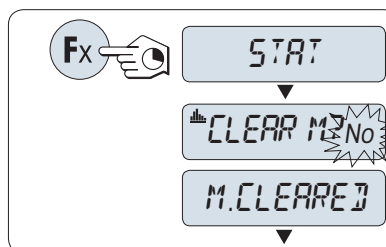

Weighing the first sample weight

- 1 Press $\rightarrow 0 \leftarrow$ to zero the balance.
- 2 Load the first sample weight.
- 3 Press \leftarrow .
 - \rightarrow The display shows the sample count - 1 - and the current weight is stored as sample and the weight is printed out.
- 4 When the sample counter is displayed you may press and hold **C** to undo (drop) this sample.
- 5 Unload the first sample weight.

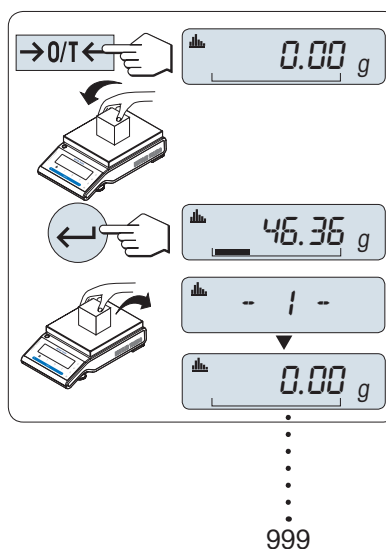

Weighing further sample weights

The same procedure as for the first sample weight.

- 1...999 samples are possible.
- The next value will be accepted if the sample weight is in the range 70% –130% of the current average value. **OUT OF RANGE** will be displayed if the sample is not accepted.

Results



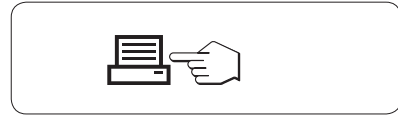







- Press  if the numbers of sample are greater than or equal to 2.
 - ➔ The results are displayed and printed.

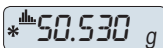
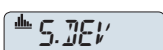
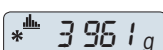

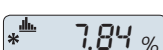
Displayed results

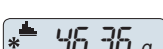
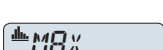
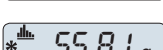
- 1 Press  to show the next statistical value.
- 2 Press **C** to cancel displaying results and to continue weighing next sample.

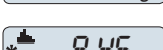
0.5 seconds

number of samples		▶		5	←
average		▶		50.530 g	←
standard deviation		▶		3.961 g	←
relative standard deviation		▶		7.84 %	←
lowest value (minimum)		▶		46.36 g	←
highest value (maximum)		▶		55.81 g	←
different between the minimum and the maximum		▶		9.45 g	←
sum of all values		▶		252.65 g	←

Terminate the application

Press and hold  to terminate the application and to return to the weighing application.

6.4 Application formulation (Net total)



The **Formulation** (Net total) application allows you to

- weigh in (add and store) up to 999 individual component weights and display the total. If a printer is connected, the component weights are printed individually and as a total.
- tare/pre-tare and store up to 999 container weights and display the total. If a printer is connected, the tare weights are printed individually and as a total.
- fill up the sum of all component net weight values by adding a further component to a higher value.

Requirement: the function **FORMULA** must be assigned to an **Fx** key. **See** advanced menu topic **ASSIGN:Fx**. Connect a printer or a PC if present.



Note

Connect a printer or a PC if present.

- Press and hold the appropriate assigned **Fx** key to activate the function **FORMULA**.
- Press \leftarrow to continue formulation weighing.
- Press \rightarrow or (+ or -) to start a new formulation.
- Press \leftarrow and select **Yes** to clear the memory.

If the memory is already cleared (sample and tare/pre-tare counter is zero) the memory clear question will be not displayed.

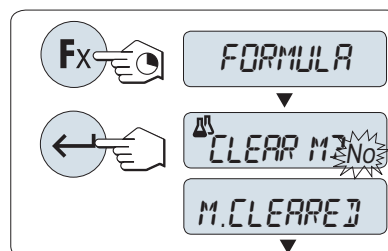

Tare container

If used.

- Press $\rightarrow 0 \leftarrow$ to zero the balance.
- Place the empty container on the weighing pan.
- Press $\rightarrow T \leftarrow$ to tare the balance.
 - The container is tared and the tare count - T1 - is displayed and the tare weight is printed.
- If you pre-tare via MT-SICS, e.g., bar code reader - **PT1** - is displayed.
- Zero range setting (menu topic **ZERO RNG**) has no effect. The zero-limit is less than or equal 10d.

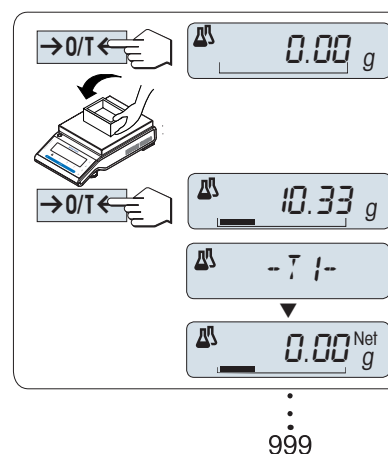

Weighing the first component weight

- 1 Load the first component weight.
- 2 Press .
 - ➔ The display briefly shows the component count - 1 -, the current weight is stored as sample and the component weight is printed. The display is set back to zero.

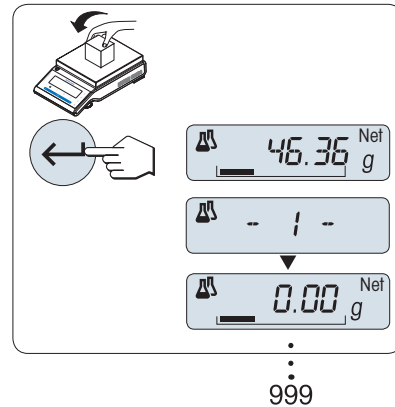

Weighing further component weights

The same procedure as for the first component weight with the same or new container).

- 1...999 sample values are possible.
- max 999 tare values are possible.
- max 999 pre-tare values are possible.

Results

- Press , if the numbers of sample are greater than or equal to 2.
 - ➔ The results are displayed and printed.

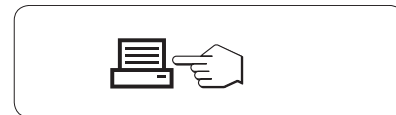

Displayed results

- 1 Press to show the next statistical value.
- 2 Press **C** to cancel displaying results and to continue weighing next component.

	0.5 seconds	
number of samples	N	8
sum of all tare values (T and PT)	T.TOTAL	452.76 g
sum of all component gross weight values	G.TOTAL	546.79 g
sum of all component net weight values	N.TOTAL	94.03 g

Function FILL UP

This function allows you to add an additional component weight to the total weight of all components to reach a desired target weight (Fill up).

Starting the fill up function

- 1 Press **+** to activate the function **FILL UP**.
- 2 Press **-** to deactivate the function **FILL UP**.

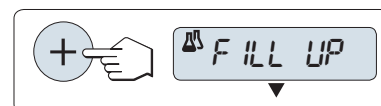

Filling up with an additional component weight

- The last total of the component weights is displayed.
- 1 Add component weight until the desired target weight is reached.
- 2 Press \leftarrow to confirm.
- ➔ The display briefly shows the next component count marked with **F**, the current weight is stored as sample and the component weight is printed. The display is set back to zero.

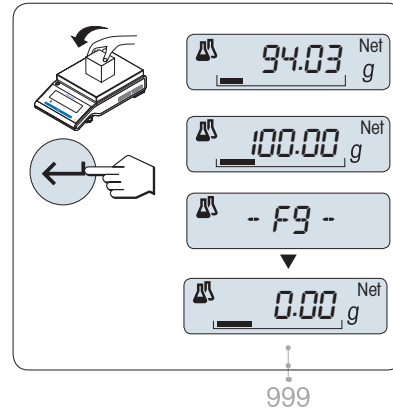

Filling up further additional component weights

The same procedure, beginning with starting up the **FILL UP** function.

Terminate the application

Press and hold $\Delta\Delta$ to terminate the application and to return to the weighing application.

6.5 Application totaling

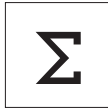

The **TOTALING** application allows you to weigh in different samples to add their weight values and to totalize them. 1 to 999 samples are possible.

Requirement: the function **TOTALING** must be assigned to an **Fx** key. **See** advanced menu topic **ASSIGN:Fx**.

- 1 Press and hold the appropriate assigned **Fx** key to activate the function **TOTALING**.
 - 2 Press \curvearrowright or (+ or -) to start a new totaling evaluation.
 - 3 Press \leftarrow and select **Yes** to clear the memory.
 - 4 Press $\rightarrow 0/T \leftarrow$ to zero the balance.
- If the memory is already cleared (sample counter is 0) the memory clear question will be not displayed.

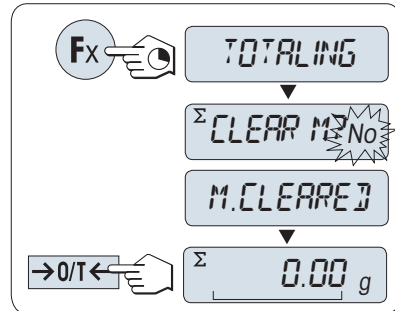

Weighing in the sample weight

- 1 Press $\rightarrow 0 \leftarrow$ to zero the balance. If using: place empty container on the weighing pan and press $\rightarrow T \leftarrow$ to tare the balance.
- 2 Load the first sample weight.
- 3 Press \leftarrow .
 - ➔ The display shows the sample count - 1 - and the current weight is stored.
- 4 When the sample counter is displayed you may press and hold **C** to undo (drop) this sample.
- 5 Unload the first sample weight.
 - ➔ The display shows zero.

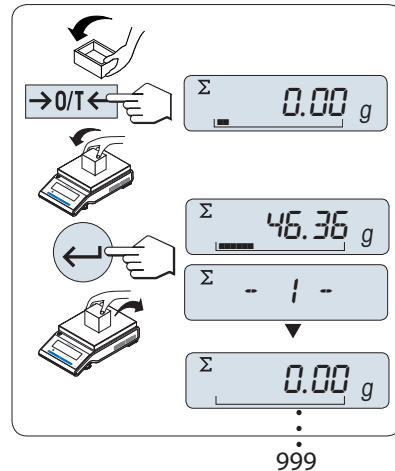

Weighing in further sample weights

The same procedure as for the first sample weight.

- 1...999 samples are possible.

Results

- Press $\left[\text{Print} \right]$, if the numbers of sample are greater than or equal to 2.
 - ➔ The results are displayed and printed.

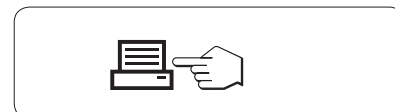

Displayed results

- 1 Press \leftarrow to show the totaled value.
- 2 Press **C** to cancel.

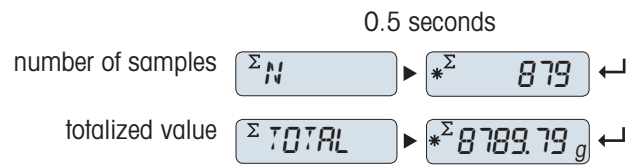

Terminate the application

Press and hold $\Delta\Delta$ to terminate the application and to return to the weighing application.

6.6 Application multiplication factor weighing



The **Multiplication factor weighing** application allows you to multiply the weight value (in grams) by a predefined factor (result = factor * weight) and have it calculated to a predefined number of decimal places.

Requirement: the function **FACTOR M** must be assigned to an **Fx** key. **See** advanced menu topic **ASSIGN:Fx**.

- Press and hold the appropriate assigned **Fx** key to activate the function **FACTOR M**.



Setting the factor value

Zero for multiplication factor value is outside the allowed range, the error message **FACTOR OUT OF RANGE** will be displayed.

- 1 Press \leftarrow to execute **SET.F.MUL**.
 - ➔ Either the factor 1 appears as default value or the factor that was saved most recently.
- 2 Press \curvearrowright to select a digit.
 - ➔ The selected digit is blinking.
- 3 Press **+** to scroll up or **-** to scroll down to changing digits.
- 4 Press \leftarrow to confirm (no automatic acceptance).

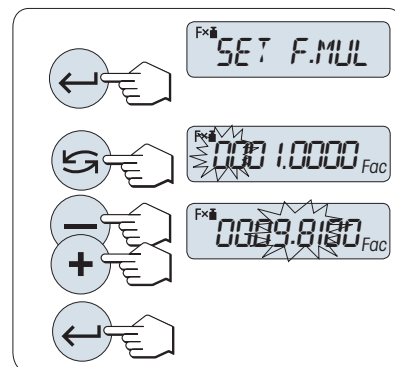

Setting the step value

SET.STEP appears on the display, and the program changes automatically to allow the display increments to be entered. The smallest possible display increment appears as default value, or the last value that was saved.

The allowed range for the step depends on the factor and the resolution of the balance. If it is outside the allowed range, the error message **STEP OUT OF RANGE** will be displayed.

- 1 Press \leftarrow to execute **SET.STEP**.
 - 2 Press \curvearrowright to select a digit.
 - ➔ The selected digit is blinking.
 - 3 Press **+** to scroll up or **-** to scroll down to changing digits.
 - 4 Press \leftarrow to confirm (no automatic acceptance).
- If without any key press within 60 seconds or by pressing **C**, the balance returns to the previous active application.

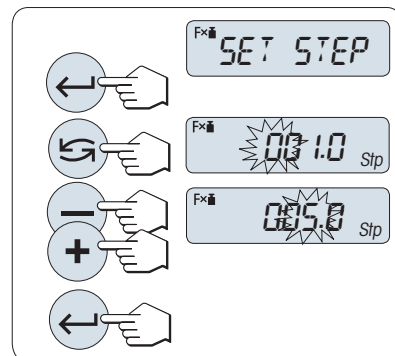

On completion of the setting procedure, your balance is ready.

Weighing procedure

- 1 Press $\rightarrow 0/T \leftarrow$ to zero the balance.
- 2 Load sample weight.
- 3 Read the result.
 - ➔ The appropriate calculation is then made using the weight of sample and the selected factor, the result being displayed with the selected display step. No units are displayed.
- 4 Unload sample weight.

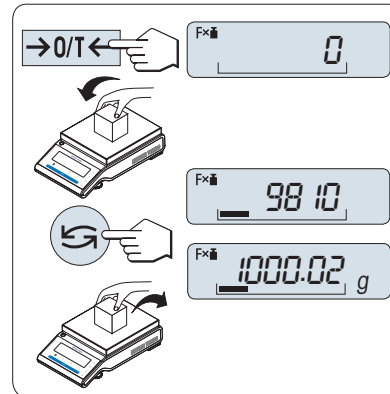

Toggling between displaying the calculated value and the measured weight

- Press \leftrightarrow key at any time to switch the display between percent display, weighing unit **UNIT 1**, **RECALL** value (if activated) and weighing unit **UNIT 2** (if different from **UNIT 1**).

Terminate the application

Press and hold $\Delta \nabla$ to terminate the application and to return to the weighing application.

6.7 Application division factor weighing



The **Division factor weighing** divide a predefined factor by the weight value (in grams) (result = factor / weight) and have it rounded to a predefined number of decimal places.

Requirement: the function **FACTOR D** must be assigned to an **Fx** key. See advanced menu topic **ASSIGN:Fx**.

- Press and hold the appropriate assigned **Fx** key to activate the function **FACTOR D**.



Setting the factor value

Zero for division factor value is outside the allowed range, the error message **FACTOR OUT OF RANGE** will be displayed.

- 1 Press \leftarrow to execute **SET.F.DIV**.
 - ➔ Either the factor 1 appears as default value or the factor that was saved most recently.
- 2 Press \curvearrowright to select a digit.
 - ➔ The selected digit is blinking.
- 3 Press **+** to scroll up or **-** to scroll down to changing digits.
- 4 Press \leftarrow to confirm (no automatic acceptance).

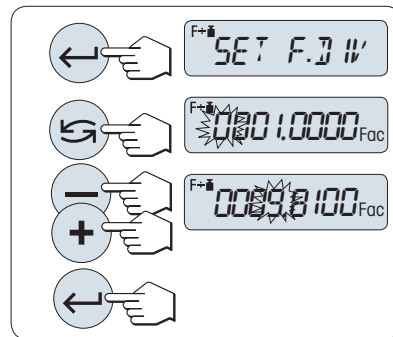

Setting the step value

SET.STEP appears on the display, and the program changes automatically to allow the display increments to be entered. The smallest possible display increment appears as default value, or the last value that was saved.

The allowed range for the step depends on the factor and the resolution of the balance. If it is outside the allowed range, the error message **STEP OUT OF RANGE** will be displayed.

- 1 Press \leftarrow to execute **SET.STEP**.
 - 2 Press \curvearrowright to select a digit.
 - ➔ The selected digit is blinking.
 - 3 Press **+** to scroll up or **-** to scroll down to changing digits.
 - 4 Press \leftarrow to confirm (no automatic acceptance).
- If without any key press within 60 seconds or by pressing **C**, the balance returns to the previous active application.

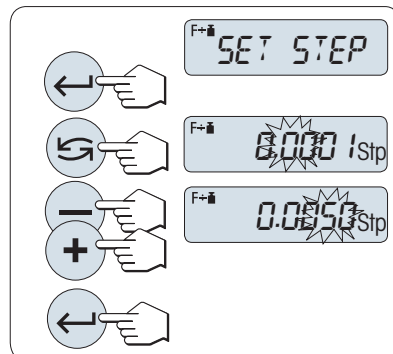

On completion of the setting procedure, your balance is ready.

Weighing procedure

- 1 Press $\rightarrow 0/T \leftarrow$ to zero the balance.
- 2 Load sample weight.
- 3 Read the result.
 - ➔ The appropriate calculation is then made using the weight of sample and the selected factor, the result being displayed with the selected display step. No units are displayed.
- 4 Unload sample weight.

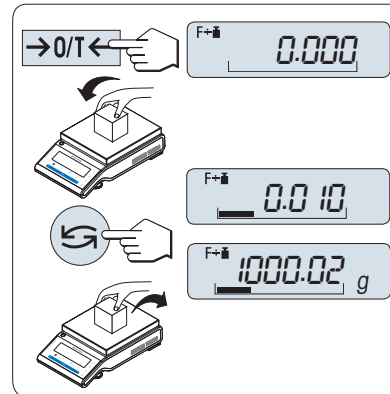

Toggling between displaying the calculated value and the measured weight

- Press \leftrightarrow key at any time to switch the display between percent display, weighing unit **UNIT 1**, **RECALL** value (if activated) and weighing unit **UNIT 2** (if different from **UNIT 1**).

Terminate the application

Press and hold $\Delta \nabla$ to terminate the application and to return to the weighing application.

6.8 Application density



The **DENSITY** application allows you to determine the density of solid bodies and liquids. Determination of the density uses **Archimedes' principle** according to which a body immersed in a fluid undergoes an apparent loss in weight which is equal to the weight of the fluid it displaces.

To determine the density of solid bodies, we recommend you to work with the optional density kit which contains all the attachments and aids needed for convenient and precise density determination. To determine the density of liquids, you additionally need a sinker which you can also obtain from your METTLER TOLEDO dealer.

Note for performing of density determinations

- You can also use the weighing hook for weighing below the balance which belongs to your balance.
- If a METTLER TOLEDO printer is attached to your balance, the settings will be automatically recorded.



We recommend you to consult the manual enclosed with the density kit.

Requirement: the function **DENSITY** must be assigned to an **Fx** key. See advanced menu topic **ASSIGN:Fx**. Density kit is installed.

- Press and hold the appropriate assigned **Fx** key to activate the function **DENSITY**.



Setting the method for density determination

- 1 Select:
SOLID, the function for the density determination of solids, or
LIQUID, the function for the density determination of liquids with a sinker.
- 2 Press \leftarrow to confirm.

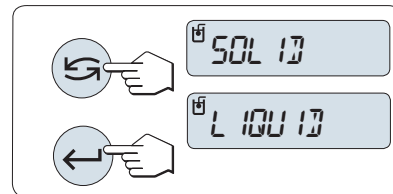

Switching the display between user guidance and weighing

- Press \leftarrow to toggle the display between user guidance and weighing.

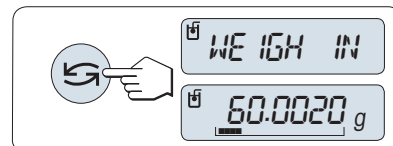



Terminate the application

Press and hold $\Delta\Delta$ to terminate the application and to return to the weighing application.

6.8.1 Density determination of solids

Setting the parameter of the auxiliary liquid

- Method **SOLID** is set.
- 1 Press  or (+ or -) to select the auxiliary liquid:
H-2-O for distilled water, **ETHANOL** or **FREE** for a freely definable auxiliary liquid.
- 2 Press  to confirm.

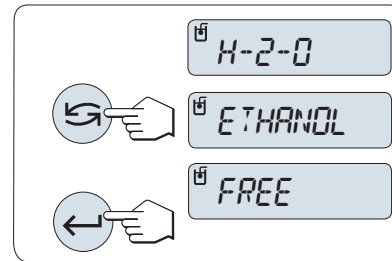

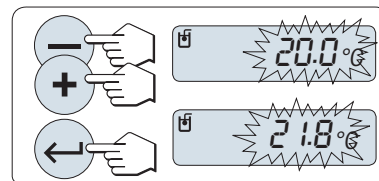

If you have selected water or ethanol as the auxiliary liquid

- 1 Enter the current temperature of the auxiliary liquid (read off on thermometer).
- 2 Change the value by scrolling up + or down -. The temperature ranges from 10°C to 30.9°C.
- 3 Press  to confirm.



The densities of distilled water and ethanol in the range 10°C to 30.9°C are stored in the balance.

If you have selected a freely definable auxiliary liquid

- 1 Enter the density of the auxiliary liquid at the current temperature (read off on thermometer).
- 2 Press  to select a digit.
➔ The selected digit is blinking.
- 3 Press + to scroll up or - to scroll down to changing digits.
- 4 Press  to confirm.

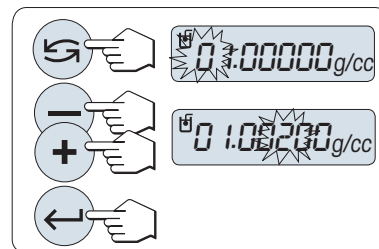

If without any key press within 60 seconds or by pressing **C**, the balance returns to the previous active application.

On completion of the setting procedure, your balance is ready.

Taring the balance is possible at any time.

The balance prompts you: **PRESS ENTER TO START.**

- Press  to start.
- ➔ Tare/Zero is executed.

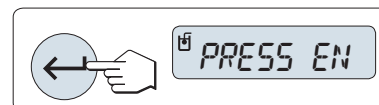

The balance prompts you to weigh the solid in air **WEIGH IN AIR.**

- 1 Load the solid.
- 2 Press  to initiate the measurement.



The balance prompts you to weigh the solid in the auxiliary liquid **WEIGH IN LIQUID.**

- 1 Load the solid.
- 2 Press  to initiate the measurement.
➔ The balance now shows the determined density of the solid.



- This result has already been corrected for the air buoyancy. The buoyancy caused by the two immersed wires (\varnothing 0.6 mm) can be neglected.
- Press **C** the balance returns to **PRESS ENTER TO START**.

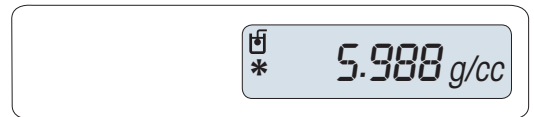

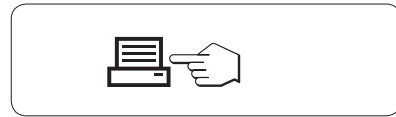

Result

- Press .
 - ➔ The result will be printed.



6.8.2 Density determination of liquids

Setting the displacement volume of your sinker

- Method **LIQUID** is set.
- 1 Press  to confirm the default value of 10.0 cm³ or change it if needed.
- 2 Press  to select a digit.
 - ➔ The selected digit is blinking.
- 3 Press **+** to scroll up or **-** to scroll down to changing digits.
- 4 Press  to confirm.

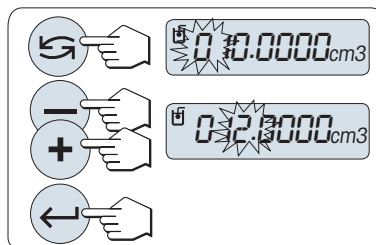

If without any key press within 60 seconds or by pressing **C**, the balance returns to the previous active application.

On completion of the setting procedure, your balance is ready.

Taring the balance is possible at any time.

The balance prompts you: **PRESS ENTER TO START**.

- Press  to start.

The balance prompts you to weigh the sinker in air **WEIGH IN AIR**.

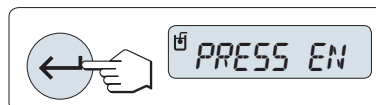

- 1 Position the sinker.
- 2 Press  to initiate the measurement.

The balance prompts you to weigh the sinker in the liquid **WEIGH IN LIQUID**.



- 1 Pour the liquid into the beaker. Make sure that the sinker is immersed by at least 1 cm in the liquid, and that there are no air bubbles in the container.
- 2 Press  to initiate the measurement.
 - ➔ The balance now shows the determined density of the liquid at the current temperature (read off on the thermometer).



- This result has already been corrected for the air buoyancy. The buoyancy caused by the immersed wire (\varnothing 0.2 mm) of the sinker can be neglected.

- Press **C** the balance returns to **PRESS ENTER TO START**.

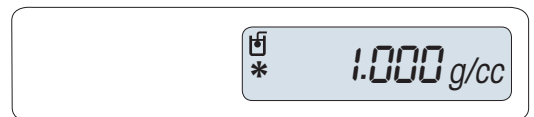

Result

- Press .
- The result will be printed.



6.8.3 Formulae used to calculate density

The **DENSITY** application is based on the formulae listed below.

Formulae for determining the density of solids with compensation for air density

$$\rho = \frac{A}{A-B} (\rho_0 - \rho_L) + \rho_L$$

$$V = \alpha \frac{A - B}{\rho_0 - \rho_L}$$

- ρ = Density of the sample
- A = Weight of the sample in air
- B = Weight of the sample in the auxiliary liquid
- V = Volume of the sample
- ρ_0 = Density of the auxiliary liquid
- ρ_L = Density of air (0.0012 g/cm³)
- α = Weight correction factor (0.99985), to take the atmospheric buoyancy of the adjustment weight into account

Formula for determining the density of liquids with compensation for air density

$$\rho = \alpha \frac{P}{V} + \rho_L$$

- ρ = Density of the liquid
- P = Weight of the displaced liquid
- V = Volume of the sinker
- ρ_L = Density of air (0.0012 g/cm³)
- α = Weight correction factor (0.99985), to take the atmospheric buoyancy of the adjustment weight into account

Density of H₂O given in g/cm³

According to the "American Institute of Physics Handbook".

T/°C	0.0	0.1	0.2	0.3	0.4	0.5	0.6	0.7	0.8	0.9
10.	0.99973	0.99972	0.99971	0.99970	0.99969	0.99968	0.99967	0.99966	0.99965	0.99964
11.	0.99963	0.99962	0.99961	0.99960	0.99959	0.99958	0.99957	0.99956	0.99955	0.99954
12.	0.99953	0.99951	0.99950	0.99949	0.99948	0.99947	0.99946	0.99944	0.99943	0.99942
13.	0.99941	0.99939	0.99938	0.99937	0.99935	0.99934	0.99933	0.99931	0.99930	0.99929
14.	0.99927	0.99926	0.99924	0.99923	0.99922	0.99920	0.99919	0.99917	0.99916	0.99914
15.	0.99913	0.99911	0.99910	0.99908	0.99907	0.99905	0.99904	0.99902	0.99900	0.99899
16.	0.99897	0.99896	0.99894	0.99892	0.99891	0.99889	0.99887	0.99885	0.99884	0.99882
17.	0.99880	0.99879	0.99877	0.99875	0.99873	0.99871	0.99870	0.99868	0.99866	0.99864
18.	0.99862	0.99860	0.99859	0.99857	0.99855	0.99853	0.99851	0.99849	0.99847	0.99845
19.	0.99843	0.99841	0.99839	0.99837	0.99835	0.99833	0.99831	0.99829	0.99827	0.99825
20.	0.99823	0.99821	0.99819	0.99817	0.99815	0.99813	0.99811	0.99808	0.99806	0.99804
21.	0.99802	0.99800	0.99798	0.99795	0.99793	0.99791	0.99789	0.99786	0.99784	0.99782
22.	0.99780	0.99777	0.99775	0.99773	0.99771	0.99768	0.99766	0.99764	0.99761	0.99759
23.	0.99756	0.99754	0.99752	0.99749	0.99747	0.99744	0.99742	0.99740	0.99737	0.99735
24.	0.99732	0.99730	0.99727	0.99725	0.99722	0.99720	0.99717	0.99715	0.99712	0.99710
25.	0.99707	0.99704	0.99702	0.99699	0.99697	0.99694	0.99691	0.99689	0.99686	0.99684
26.	0.99681	0.99678	0.99676	0.99673	0.99670	0.99668	0.99665	0.99662	0.99659	0.99657
27.	0.99654	0.99651	0.99648	0.99646	0.99643	0.99640	0.99637	0.99634	0.99632	0.99629
28.	0.99626	0.99623	0.99620	0.99617	0.99614	0.99612	0.99609	0.99606	0.99603	0.99600
29.	0.99597	0.99594	0.99591	0.99588	0.99585	0.99582	0.99579	0.99576	0.99573	0.99570
30.	0.99567	0.99564	0.99561	0.99558	0.99555	0.99552	0.99549	0.99546	0.99543	0.99540

Density of C₂H₅OH given in g/cm³

According to the "American Institute of Physics Handbook".

T/°C	0.0	0.1	0.2	0.3	0.4	0.5	0.6	0.7	0.8	0.9
10.	0.79784	0.79775	0.79767	0.79758	0.79750	0.79741	0.79733	0.79725	0.79716	0.79708
11.	0.79699	0.79691	0.79682	0.79674	0.79665	0.79657	0.79648	0.79640	0.79631	0.79623
12.	0.79614	0.79606	0.79598	0.79589	0.79581	0.79572	0.79564	0.79555	0.79547	0.79538
13.	0.79530	0.79521	0.79513	0.79504	0.79496	0.79487	0.79479	0.79470	0.79462	0.79453
14.	0.79445	0.79436	0.79428	0.79419	0.79411	0.79402	0.79394	0.79385	0.79377	0.79368
15.	0.79360	0.79352	0.79343	0.79335	0.79326	0.79318	0.79309	0.79301	0.79292	0.79284
16.	0.79275	0.79267	0.79258	0.79250	0.79241	0.79232	0.79224	0.79215	0.79207	0.79198
17.	0.79190	0.79181	0.79173	0.79164	0.79156	0.79147	0.79139	0.79130	0.79122	0.79113
18.	0.79105	0.79096	0.79088	0.79079	0.79071	0.79062	0.79054	0.79045	0.79037	0.79028
19.	0.79020	0.79011	0.79002	0.78994	0.78985	0.78977	0.78968	0.78960	0.78951	0.78943
20.	0.78934	0.78926	0.78917	0.78909	0.78900	0.78892	0.78883	0.78874	0.78866	0.78857
21.	0.78849	0.78840	0.78832	0.78823	0.78815	0.78806	0.78797	0.78789	0.78780	0.78772
22.	0.78763	0.78755	0.78746	0.78738	0.78729	0.78720	0.78712	0.78703	0.78695	0.78686
23.	0.78678	0.78669	0.78660	0.78652	0.78643	0.78635	0.78626	0.78618	0.78609	0.78600
24.	0.78592	0.78583	0.78575	0.78566	0.78558	0.78549	0.78540	0.78532	0.78523	0.78515
25.	0.78506	0.78497	0.78489	0.78480	0.78472	0.78463	0.78454	0.78446	0.78437	0.78429
26.	0.78420	0.78411	0.78403	0.78394	0.78386	0.78377	0.78368	0.78360	0.78351	0.78343
27.	0.78334	0.78325	0.78317	0.78308	0.78299	0.78291	0.78282	0.78274	0.78265	0.78256
28.	0.78248	0.78239	0.78230	0.78222	0.78213	0.78205	0.78196	0.78187	0.78179	0.78170
29.	0.78161	0.78153	0.78144	0.78136	0.78127	0.78118	0.78110	0.78101	0.78092	0.78084
30.	0.78075	0.78066	0.78058	0.78049	0.78040	0.78032	0.78023	0.78014	0.78006	0.77997

6.9 Application pipette check



The **PipetteCheck** application allows you to check the volume of pipettes from any manufacturer, with the gravimetric method. For checking pipettes we recommend using the optional METTLER TOLEDO evaporation trap. This evaporation trap minimizes moisture evaporation for more accurate results.

Maximum 3 different test volumes are possible for checking the pipette. The test volumes recommended by the manufacturer are usually 10%, 50%, and 100% of the nominal volume of the pipette. The liquid to determine the volume of the pipette is water and the following conditions must be known:

- Current temperature of the test liquid
- Current barometric air pressure of the test environment
- Current relative humidity of the test environment

Based on the test results on the printout of the statistic and your specifications, you can decide whether the pipette can be used for further applications (successfully or failed).

Requirement

- A printer must be connected.
- The evaporation trap is ready installed (recommended).
- The function **PIPETTE** must be assigned to an **Fx** key. **See** advanced menu topic **ASSIGN:Fx**. Density kit is installed.

- Press and hold the appropriate assigned **Fx** key to activate the function **PIPETTE**.



Setup

Setting the test liquid temperature

The setting range is 15.0°C up to 30.0°C.

- 1 Press **+** to scroll up or **-** to scroll down to changing digits.
- 2 Press **←** to confirm (no automatic acceptance).

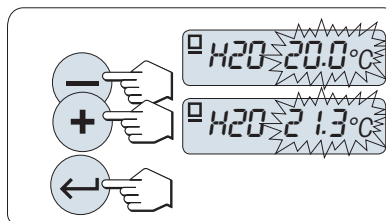

Setting the barometric air pressure of the test environment

The setting range is 850 hPa up to 1090 hPa.

- 1 Press **+** to scroll up or **-** to scroll down to changing digits.
- 2 Press **←** to confirm (no automatic acceptance).

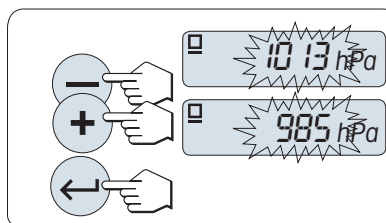

Setting the relative humidity of the test environment

The setting range is 20% up to 90%.

- 1 Press **+** to scroll up or **-** to scroll down to changing digits.
- 2 Press **←** to confirm (no automatic acceptance).

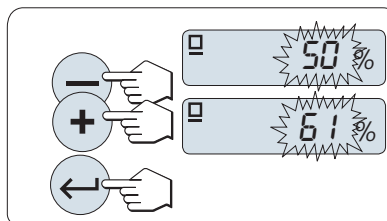

Setting the sample size

Set how many measurements should be performed for the selected test volume before the measurement cycle is complete.

The setting range is from 4 up to 10.

- 1 Select the sample size.
- 2 Press **↻** to toggle between the values 4 to 10.
- 3 Press **←** to confirm (no automatic acceptance).

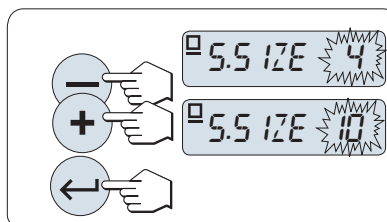

Setting the test volume

The setting range is 1 μ l up to 20000 μ l.

- 1 Press **↻** to select a digit.
 - ➔ The selected digit is blinking.
- 2 Press **+** to scroll up or **-** to scroll down to changing digits.
- 3 Press **←** to confirm the setting and to start the pipette check.
 - ➔ Application header and settings are printed.

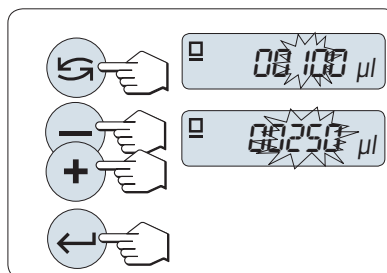

If without any key press within 60 seconds or by pressing **C**, the balance returns to the previous active application.

Pipette check start

- **Sample 1** appears briefly on the display (Sample counter).
- The balance shows zero.
- 1 Weigh the first sample.
- 2 Press **←** to confirm.
 - ➔ The weight of sample 1 is stored and printed.
- 3 Weigh next samples with the same procedure as for the first sample, until the defined number of samples is reached.
 - ➔ The statistics is printed and shown on the display.

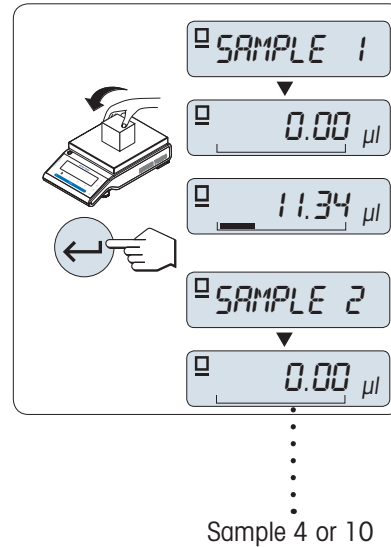

Displayed results

- 1 Press **←** (several times) to show all statistic values on the display first.
- 2 Press **C** to continue the pipette check.

	0.5 seconds
systematic error, absolute	<div style="display: flex; align-items: center; gap: 10px;"> <div style="border: 1px solid gray; padding: 2px;">SYS.ERR_{abs}</div> <div style="font-size: 20px;">▶</div> <div style="border: 1px solid gray; padding: 2px;">* 1.24 µl</div> <div style="font-size: 20px;">←</div> </div>
systematic error, relative	<div style="display: flex; align-items: center; gap: 10px;"> <div style="border: 1px solid gray; padding: 2px;">SYS.ERR_{rel}</div> <div style="font-size: 20px;">▶</div> <div style="border: 1px solid gray; padding: 2px;">* 10.91%</div> <div style="font-size: 20px;">←</div> </div>
random error, absolute	<div style="display: flex; align-items: center; gap: 10px;"> <div style="border: 1px solid gray; padding: 2px;">RANJ.ERR_{abs}</div> <div style="font-size: 20px;">▶</div> <div style="border: 1px solid gray; padding: 2px;">* 0.13 µl</div> <div style="font-size: 20px;">←</div> </div>
random error, relative	<div style="display: flex; align-items: center; gap: 10px;"> <div style="border: 1px solid gray; padding: 2px;">RANJ.ERR_{rel}</div> <div style="font-size: 20px;">▶</div> <div style="border: 1px solid gray; padding: 2px;">* 1.32%</div> <div style="font-size: 20px;">←</div> </div>

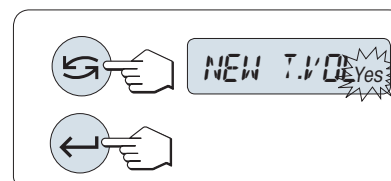

Continue pipette check

- Continue the check with another test volume. Three different test volumes are possible. After three test volume, the balance terminates the check of the pipette automatically.
- Terminate pipette check.
- **NEW T.VOL** appears on the display.
- 1 Select **YES** to continue or select **NO** to terminate the check of the pipette.
- 2 Press **↻** to toggle between **YES** or **NO**.
- 3 Press **←** to confirm.



Continue next pipette check

- 1 Set the next test volume.

- 2 Press  to select a digit.
 - ➔ The selected digit is blinking.
- 3 Press **+** to scroll up or **-** to scroll down to changing digits.
- 4 Press  to confirm the setting and to start the pipette check.
 - ➔ The sample header with the new test volume is printed.
- 5 To continue, refer to section "Pipette check start". Same procedure for further test volume.

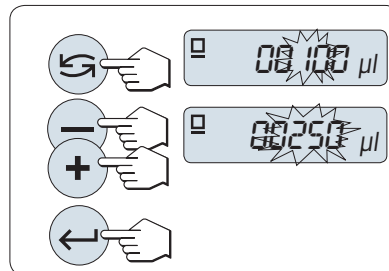

Terminate pipette check

The printout will be completed and the balance returns to the weighing application.

6.10 Application routine test

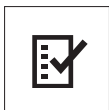

The **Routine test** application allows you to determine the sensitivity of the balance. More about periodic sensitivity tests (routine tests), **See GWP® (Good Weighing Practice)** on ► <http://www.mt.com/gwp>.

GWP gives clear recommendation for routine testing:

- how should I test my balance?
- how often?
- where can I reduce efforts?

More about test weights, **see** ► <http://www.mt.com/weights>.

Requirement

- The function **R. TEST** must be assigned to an **F3** key. **See** advanced menu topic **ASSIGN:F3**.
- It is recommended to connect a printer or a PC to the balance for showing the results.

- 1 Press and hold the appropriate assigned **Fx** key to activate the function **R. TEST**.
- 2 Press **↵** or **(+ or -)** to toggle between **No** or **Yes** to use a tare weigh for test.
- 3 Press **←** to confirm.
- 4 Press **→0/T←** to zero or tare the balance.
 - It is recommended to test the sensitivity without tare load. (**Factory setting: No**).
 - If using tare: Make sure that tare weight plus test weight is not exceeding max. load.

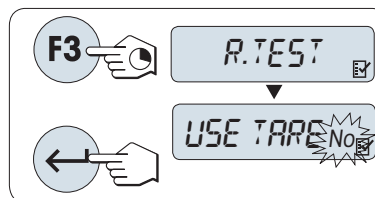

Setting the reference test weight value

The default value of the test weight: Next smaller OIML weight than the maximum load of your balance according to the GWP® recommendation.

- 1 For changing the value, press **+** to scroll up or **-** to scroll down. Progressing speed by press and hold.
- 2 Press **←** to confirm.

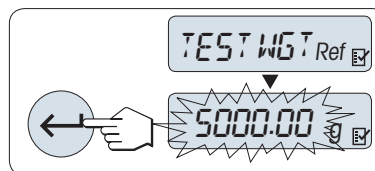

Setting the control limit

The default value of the control limit:

Test weight × weighing process tolerance / 2

Example: 5000 g × 0.1% / 2 = 2.50 g.

- 1 For changing the value, press **+** to scroll up or **-** to scroll down. Progressing speed by press and hold.
- 2 Press **←** to confirm.

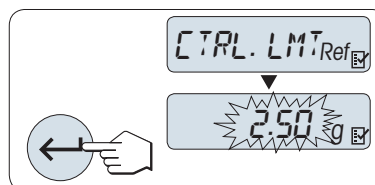

Setting the warning limit

The default value of the warning limit:

Warning limit = control limit / safety factor

Example: $2.5 \text{ g} / 2 = 1.25 \text{ g}$.

- 1 For changing the value, press **+** to scroll up or **-** to scroll down. Progressing speed by press and hold.
- 2 Press **←** to confirm.

The default values of control limit and the warning limit are evaluated according to the GWP recommendation. These are based under the assumption that the weighing process tolerance is 0.1% and the safety factor is 2.

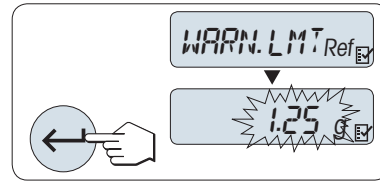

On completion of the setting procedure, your balance is ready.

The test weight must be acclimatized to the ambient temperature of the balance.

- 1 Press **←** to start.
 - ➔ Follow the instructions on the display.
- 2 Load the test weight (displayed value), when the test weight value is flashing.
 - ➔ The printout starts after the weighing pan is unloaded.

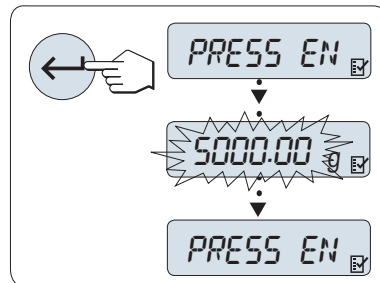

Exit the current test procedure

- Press and hold **△△** for executing a new application.

What if warning limit or control limit are FAILED?

The "SOP for Periodic Sensitivity Tests (Routine Tests)" provides information about measures when routine tests fail.



Find a download version of these SOPs on [▶ http://www.mt.com/gwp](http://www.mt.com/gwp), link [▶ http://http://www.mt.com/ch/en/home/library/operating-instructions/laboratory-weighing/free_standard_operating_procedures_for_balance_straightforward_testing.html](http://http://www.mt.com/ch/en/home/library/operating-instructions/laboratory-weighing/free_standard_operating_procedures_for_balance_straightforward_testing.html).

Content of SOP

- Preparation
- Test procedure
- Evaluation
- Deviation
 - If Warning Limit **FAILED**
 - If Control Limit **FAILED**

6.11 Application diagnostics

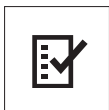

The **Diagnostics** application allows you to carry out predefined diagnostics tests and to view or print predefined sets of balance information. This diagnostics tool helps you find errors faster and more efficiently.

Requirement: A printer or a PC is connected to the balance for showing the results.

- 1 Activate **ADVANCED** menu.
- 2 Press \leftarrow to activate the function **DIAGNOSE**.
- 3 Press \rightarrow to select appropriate tests.

6.11.1 Repeatability test



Note

On models with internal weights only.

The repeatability test allows you to repeat tests with internal weight for a given number of times.

- 1 Press \leftarrow to activate repeatability test **REPEAT.T**.
 - ➔ **R. TST. 10** appears on the display.
- 2 Enter the number of times (blinking) by pressing **+** or **-**. Possible values are 5, 10 (factory setting), 20, 50, 100 times.
- 3 Press \leftarrow to start the test.
 - ➔ The message **RUNNING REPEAT TEST** appears till the tests are completed.
- 4 Press \equiv to print the test information.
- 5 Press \leftarrow to scroll forward through the displayed list.
- 6 Press **C** to cancel the test procedure.
 - ➔ The balance will return to the topic **DIAGNOSE**.

Sample information displayed

Displayed for 0.5 s	Display
S DEV	* 0.004 g
MAX. TEMP	21.2 °C
MIN. TEMP	21.0 °C
MEAN. TEMP	21.1 °C
TOT.TIME	00:01:26

Examples

Repeatability test is a tool to do functional check with the balance. It may be performed:

- **To check function of balance**
 - during installation to store print out with installation documents.
 - after preventative maintenance to store print out with installation maintenance report.
 - when remarkable decrease of weighing performance occurs, so that you can email/fax print out to service support provider for diagnose purposes.
- **To develop the optimal environment settings, see** menu topic **ENVIRON..**
Measure the time you need to perform repeatability test with each **STABLE**, **STANDARD** and **UNSTABLE** setting. The setting with the fastest total time suits best for the existing environmental conditions.

6.11.2 Display test

The display test allows you to test the display of the balance.

- 1 Press \leftarrow to start **DISPLAY**.
 - ➔ All possible segments and icons on the display will illuminate.







- 2 Press  to print the test information.
 - 3 Press **C** to cancel the test procedure.
- ➔ The balance will return to the topic **DIAGNOSE**.

6.11.3 Key test

The key test allows you to test the keys of the balance.

- 1 Press  to start **KEYPAD T**.
 - ➔ The message **KEY TEST - PRESS KEY TO BE TESTED** is displayed scrolling during the duration of the key test.
- 2 Press every key briefly. Each press of a key beeps and echoes with **OK** on the display.
- 3 Second press **C** key to print the test information.
 - ➔ The test procedure will be cancelled and the balance will return to the topic **DIAGNOSE**. If a key has not been tested before printing, then the test results will be indicated with a ---- line.



Sample information displayed

Key	Display
	1/10 D OK
	MENU OK
	CAL OK
	PRINT OK
-	MINUS OK
+	PLUS OK
	TOGGLE OK
	ENTER OK
C	C OK
→0/T←	0/T OK

6.11.4 Motor test



The motor test allows you to test the calibration motor of the balance.

 **Note:** on models with internal weight only.

- 1 Press  to start **CAL.MOT. T**.
 - ➔ **RUNNING** is displayed during the motor test. A motor test is deemed successful when all the motor positions have been successfully tested. At the end of the test, the test information will be printed.
 - 2 Press  for printout.
 - 3 Press **C** to cancel the test procedure.
- ➔ The balance will return to the topic **DIAGNOSE**.

6.11.5 Balance history

The balance history function allows you to view and print the history of the balance.

- 1 Press  to start **BAL.HIST**.
- 2 Press  for printout.
- 3 Press  to scroll forward through the displayed list of balance history information.

- 4 Press **C** to cancel the test procedure.
- ➔ The balance will return to the topic **DIAGNOSE**.

Sample information displayed

Information	Display
Operation time (year:day:hour)	00:018:04
Total load kg	115.7191 kg
Number of weighings	1255
Number of key pressed	4931
Number of motor movements	1012
Backlight time (year:day:hour)	00:018:04
Next service due date	01:01:2010

6.11.6 Adjustment history

The adjustment history function allows you to view and print information of the last 30 balance adjustments. Adjustments made by a service technician and normal user are counted together.

- 1 Press **←** to start **CAL.HIST**.
- 2 Press  for printout.
- 3 Press **←** key to scroll forward through the displayed list of adjustments history information.
- 4 Press **C** to cancel the test procedure.
- ➔ The balance will return to the topic **DIAGNOSE**.

Sample information displayed

Note	Display	
S = External adjusted service	05:03:09S	01
	-3 PPM	
F = FACT	05:03:09F	02
	2 PPM	
	.	.
	.	.
	.	.
I = Internal adjusted	04:03:09I	28
	-1 PPM	
E = External adjusted user	03:03:09E	29
	4 PPM	
F = FACT	02:03:09F	30
	1 PPM	

The PPM value is the change since the last performed FACT or adjustment.

6.11.7 Balance information

The balance information function allows you to view and print information about your balance.



- 1 Press **←** to start **BAL.INFO**.
- 2 Press  for printout.
- 3 Press **←** to scroll forward through the displayed list of balance information.
- 4 Press **C** to cancel the test procedure.
- ➔ The balance will return to the topic **DIAGNOSE**.

Sample information displayed

Information	Display
Balance type	TYPE MS6002S
Max. load	MAX 6200 g
Software platform	PLATFORM RAINBOW
Serial number	SNR 1234567890
Type definition number	TDNR 9.6.3.411
Software version	SOFTWARE V1.00
Cell ID	CELL ID 1172400044
Cell type	CELL TYPE MMAI6000G2
Tolerance revision number	TOLERANCE NO2
Language	LANGUAGE ENGLISH

6.11.8 Service provider information

The service provider Information function allows you to print information about your service provider.

- 1 Press  to start **PROVIDER**.
 - ➔ The service provider information appears.
 - 2 Press .
- ➔ The service provider information will be printed and the balance will return to the topic **DIAGNOSE**.

7 Communication with Peripheral Devices

This section lists some typical examples of where the balance can communicate with peripheral devices and networks.

7.1 USB - interface and installation

Before connecting the balance via the USB device interface to a PC and using either the **HOST** or **PC-Direct** function, the appropriate METTLER TOLEDO USB driver has to be assigned to the PC first. The USB driver can be found on ► www.mt.com/labweighing-software-download. If you have any questions, please contact a METTLER TOLEDO representative.



Note

If you connect the balance via USB to the PC before installing the METTLER TOLEDO USB driver, Windows will automatically install the wrong driver.

Requirements

- Balance with USB device interface
- PC with one of the following Microsoft Windows® 32-bit/64-bit operating systems: Win 7 (SP1), Win 8 or Win 10
- Administrator rights for installing software
- USB connection cable to connect PC to balance

Download USB driver

- 1 Connect to the internet.
- 2 Go to the site www.mt.com/labweighing-software-download.
- 3 Click **Download driver** in section **USB driver for laboratory balances**.
 - ⇒ A pop-up window with interactions appears.
- 4 Click, e.g., **Open**.
 - ⇒ The extract screen appears.
- 5 Extract the file **MT_Generic_USB_Serial_Port_Driver_SW_en_vx.xx.x.x.zip** to your specified location.
- 6 Right-click on the downloaded installation program **MT_Generic_USB_Serial_Port_Driver_vx.xx.x.x_Setup.exe** and select **Run as Administrator**.
- 7 If a safety warning appears, confirm windows to perform the installation.
- 8 Click **Next** and follow the installer's instructions.

Installing the balance

- 1 Switch the balance **off**.
- 2 Connect the balance to the preferred USB port on the PC.
- 3 Switch the balance **on**.

7.2 Send weight value via USB or RS232 to a PC using PC-Direct

The PC-Direct function of the balance allows you to transfer weight values from the balance to a Windows application. The weight value displayed on the balance is transferred to the cursor position in, e.g., Excel or Word.

The data is transferred via USB or via the serial RS232C interface.

The weight value is transferred without the unit.

Requirements

- PC with one of the following Microsoft Windows® 32-bit/64-bit operating systems: Win 7 (SP1), Win 8 or Win 10
- Serial interface RS232C or USB
- Administrator rights for installing the SerialPortToKeyboard software (if data transfer is via RS232C)

- Windows application, e.g., Excel
- Connection between balance and PC via RS232C or USB cable

7.2.1 PC-Direct via USB

The balance can send data (as a keyboard) to the PC used for PC applications, e.g. Excel. The balance sends the weight value without the unit to the PC.

Use the USB connection cable to connect the balance with the PC. Connect the USB cable to the USB device on the balance.



NOTICE

Disconnect the USB connection from the balance prior to changing settings.

Balance interface settings, **see** chapter "Interface menu".

Topic USB

- Set **PC-DIR.** and select the most appropriate option for the desired weighing result.

Topic USB E.O.L./USB E.O.L

- 1 Set **TAB** to write into the same row (e.g. in Excel).
- 2 Set **CR LF** to write into the same column (e.g. in Excel).
- 3 Save changes.
 - The balance must be disconnected from the PC.
- 1 **Connect the balance to the PC.**
- 2 Place the sample on the weighing pan.
- 3 Press , the next stable weight will be sent to the cursor position of your application.

7.2.2 PC-Direct via RS232

Balance interface settings, **see** chapter "Interface menu".

7.2.2.1 Installing SerialPortToKeyboard software

The operation of PC-Direct via serial port RS232C requires the installation of **SerialPortToKeyboard** on your host computer. The file **SerialPortToKeyboard** can be found on ► www.mt.com/labweighing-software-download. If you have any questions, please contact a METTLER TOLEDO representative.

Download SerialPortToKeyboard

- 1 Connect to the internet.
- 2 Go to the site www.mt.com/labweighing-software-download.
- 3 Click **Download Software and Instructions** in section **SerialPortToKeyboard software for Advanced and Standard level laboratory balances**.
 - ➔ A pop-up window with interactions appears.
- 4 Click, e.g., **Open**.
 - ➔ The extract screen appears.
- 5 Extract the file **SerialPortToKeyboard_V_x.xx_installer_and_instructions.zip** to your specified location.
- 6 Right-click on the downloaded installation program **SerialPortToKeyboard_V_x.xx.exe** and select **Run as Administrator**.
- 7 If a safety warning appears, confirm windows to perform the installation.
- 8 Click **Next** and follow the installer's instructions.

Checking operation

- 1 Start **SerialPortToKeyboard** (RS232C)
- 2 Start Excel (or another application) on the computer.
- 3 Activate a cell in Excel.

7.2.2.2 Balance settings

Balance interface settings, **see** chapter "Interface menu".

Topic RS232

- Set **PC-DIR**. and select the most appropriate option for the desired weighing result.

Topic RS.TX.E.O.L./RS E.O.L.

- 1 Set **TAB** to write into the same row (e.g. in Excel).
- 2 Set **CR LF** to write into the same column (e.g. in Excel).
- 3 Save changes.

8 Maintenance

To guarantee the functionality of the balance and the accuracy of the weighing results, a number of maintenance actions must be performed by the user.

8.1 Maintenance table

Maintenance action	Recommended interval	Remarks
Performing an internal adjustment	<ul style="list-style-type: none">• Daily• After cleaning• After leveling• After changing the location	see chapter "Fully automatic adjustment FACT"
Performing routine tests (sensitivity test, repeatability test). METTLER TOLEDO recommends to perform at least a sensitivity test.	<ul style="list-style-type: none">• After cleaning	see below
Cleaning	Depending on the degree of pollution or your internal regulations (SOP), clean the instrument: <ul style="list-style-type: none">• After every use• After change of sample	see chapter "Cleaning the balance"

8.2 Performing routine tests

There are several routine tests. Depending on your internal regulations, specific routine test must be performed by the user.

METTLER TOLEDO recommend to perform an sensitivity test after cleaning and reassembling the balance.

To perform a routine test, proceed how described in chapter "Application routine test".

See also

 Application routine test ▶ Page 64

 Repeatability test ▶ Page 66

8.3 Cleaning



WARNING

Death or serious injury due to electric shock

Contact with parts carrying a live current can lead to injury and death.

- 1 Disconnect the instrument from the power supply prior to cleaning and maintenance.
- 2 Prevent liquid from entering the instrument, terminal or AC/DC adapter.

8.3.1 Cleaning agents

The following table presents the cleaning tools and cleaning agents recommended by METTLER TOLEDO.

		Tools			Cleaning agents						
		Paper tissue	Brush	Dishwasher	Water	Acetone	Ethanol (70%)	Isopropanol (70%)	Hydrochloric acid (3-10 %)	Sodiumhydroxide (0.2-1.0 M)	Peracetic acid (2-3%)
Around the balance	Balance housing	✓	—	—	R	—	R	✓	R	R	R
	Top housing	✓	—	—	R	—	R	✓	R	R	R
	Housing	✓	—	—	R	—	R	✓	R	R	R
	Back housing	✓	—	—	R	—	R	✓	R	—	R
	Feet	R	—	—	R	—	R	✓	R	R	R
Display	Screen / display	✓	—	—	✓	—	R	R	R	R	R
Balance draft shield	Glass panels	R	—	✓	R	—	R	R	R	R	R
	Glass free panels	R	—	—	R	—	✓	R	R	R	R
	Non-removable handles and frames	✓	—	—	R	—	—	✓	R	R	R
Weighing area	Draft ring element / Draft shield element	R	—	✓	R	—	—	—	R	—	R
	Weighing pan	✓	—	—	R	—	✓	R	R	R	R

Symbol descriptions:

✓: Best recommendation by METTLER TOLEDO, can be used without limitation.

R: Recommended by METTLER TOLEDO, can be used without limitation.

(D): Depending on the material used: individual durability and resistance to acid and alkali must be evaluated.

— Not recommended.

8.3.2 Cleaning the glass draft shield



⚠ CAUTION

Injury due to breaking glass

Careless handling of the glass components can lead to breakage of glass and damage to cuttings.

- Always proceed focused and with care.

Removing and inserting the side door glass panels and top door glass panels.

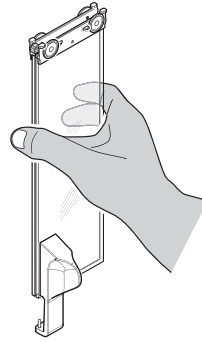

- 1 Always hold the 2 parallel guided glass panels together and parallel with one hand, **see** illustrations.

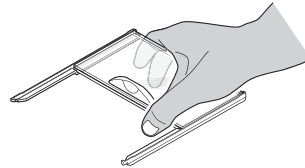

- 2 Push all the glass panels as far as they will go to the back.
- 3 Turn the top cover (1) to the front.
- 4 Pull the side door glass panels and the top door glass panels towards the back and off. (observe the important note above)
- 5 Turn the two lock covers (2) on the front as far as they will go to unlock the front glass.
- 6 Tilt the front glass forward and pull it out.
- 7 Remove draft ring.
- 8 Remove weighing pan.
- 9 Remove drip tray.

After cleaning reinstall all components in reverse order through the observance of the important notes.

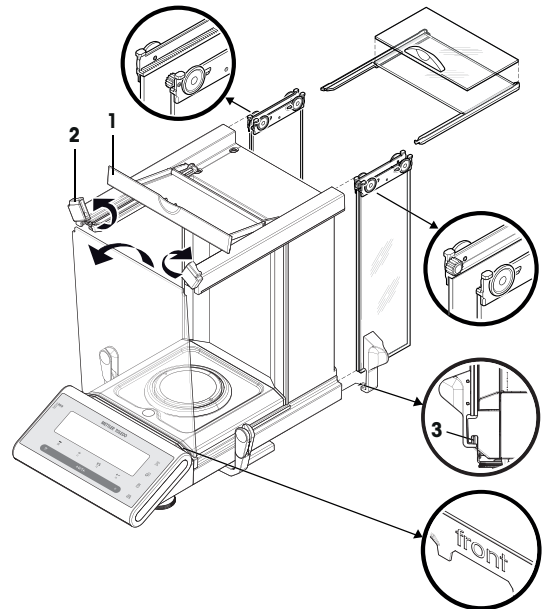

 **Note**

- Side door glass panels: The guide pin must be placed in the guide slot (3).
- After inserting the glass doors (side and top), close the top cover so that they can not fall out.
- Front glass: The writing "front" must be show forwards.

8.3.3 Cleaning the balance



NOTICE

Damage due to improper cleaning

Improper cleaning can damage the load cell or other essential parts.

- 1 Do not use any cleaning agents other than the ones specified in the "Reference Manual" or "Cleaning Guide".
- 2 Do not spray or pour liquids on the instrument. Always use a moistened lint-free cloth or a tissue.
- 3 Always wipe out from inside to outside of the instrument.

Cleaning around the balance

- Remove any dirt or dust around the balance and avoid further contaminations.

Cleaning the removable parts

- Clean the removed part with a damp cloth or a tissue and a mild cleaning agent.

Cleaning the balance

- 1 Disconnect the balance from the AC/DC adapter.
- 2 Use a lint-free cloth moistened with a mild cleaning agent to clean the surface of the balance.
- 3 Remove powder or dust at first with a disposable tissue.
- 4 Remove sticky substances with a damp lint-free cloth and a mild solvent.

8.3.4 Putting into operation after cleaning

- 1 Reassemble the balance.
 - 2 Check the functionality of the draft shield.
 - 3 Press **On/Off** to switch on the balance.
 - 4 Warm up the balance. Wait 1h for the acclimatization, before starting the tests.
 - 5 Check the level status, level the balance if necessary.
 - 6 Perform an internal adjustment.
 - 7 Perform a routine test due to the internal regulations of your company. METTLER TOLEDO recommends to perform a repeatability test after cleaning the balance.
 - 8 Press **→0/T←** to zero the balance.
- ➔ The balance has been putting into operation and is ready to use.

See also

- 📄 Leveling the balance ▶ Page 13
- 📄 Adjustment ▶ Page 15
- 📄 Application routine test ▶ Page 64
- 📄 Repeatability test ▶ Page 66

9 Troubleshooting

Possible errors with their cause and remedy are described in the following chapter. If there are errors that cannot be corrected through these instructions, contact METTLER TOLEDO.

9.1 Error messages

Error message	Possible cause	Diagnostic	Remedy
NO STABILITY	Vibrations at the workplace.	Place beaker with tap water on the weighing table. Vibrations cause ripples on the water surface.	<ul style="list-style-type: none"> Protect weighing location against vibrations (vibration absorber, etc.). Set weighing parameters coarser (change ENVIRON. from STABLE to STANDARD or even UNSTABLE). Find a different weighing location (by agreement with customer).
	Draft due to untight draft shield and /or open window.	Make sure draft shield or window is closed.	<ul style="list-style-type: none"> Close draft shield or window. Set weighing parameters coarser (change ENVIRON. from STABLE to STANDARD or even UNSTABLE).
	The location is not suitable for weighing.	–	Check and observe the requirements for the location, refer to "Selecting the location".
	Something is touching the weighing pan.	Check for touching parts or dirt.	Remove touching parts or clean the balance.
WRONG ADJUSTMENT WEIGHT	Wrong adjustment weight.	Check weight.	Place correct weight on the weighing pan.
REFERENCE TOO SMALL	Reference for piece counting too small.	–	Increase reference weight.
EEPROM ERROR - PLEASE CONTACT CUSTOMER SERVICE	Data in EEPROM damaged.	–	Please contact your METTLER TOLEDO customer service.
WRONG CELL DATA - PLEASE CONTACT CUSTOMER SERVICE	Defect load cell data.	–	Please contact your METTLER TOLEDO customer service.
NO STANDARD ADJUSTMENT - PLEASE CONTACT CUSTOMER SERVICE	–	–	Please contact your METTLER TOLEDO customer service.

Error message	Possible cause	Diagnostic	Remedy
PROGRAM MEMORY DEFECT - PLEASE CONTACT CUSTOMER SERVICE	–	–	Please contact your METTLER TOLEDO customer service.
TEMP SENSOR DEFECT - PLEASE CONTACT CUSTOMER SERVICE	AC/DC adapter connected to power before connecting to the balance. Temperature sensor of load cell defect.	–	Remove the AC/DC adapter from the power and connect first to the balance before connecting to the power if persist please contact your METTLER TOLEDO customer service.
WRONG LOAD CELL BRAND - PLEASE CONTACT CUSTOMER SERVICE	Wrong load cell installed.	–	Please contact your METTLER TOLEDO customer service.
WRONG TYPE DATA SET - PLEASE CONTACT CUSTOMER SERVICE	Wrong type data set.	–	Please contact your METTLER TOLEDO customer service.
Battery backup lost	Backup battery is empty. This battery ensures that the date and time are not lost when the balance is disconnected from power.	Connect the balance to the power supply for charging the battery (full capacity after 2 days of charging).	Battery must be recharged. Please contact METTLER TOLEDO customer service.
INITIAL ZERO RANGE EXCEEDED	Wrong weighing pan. Pan is not empty.	Check weighing pan.	Mount correct weighing pan or unload weighing pan.
BELOW INITIAL ZERO RANGE	Wrong weighing pan. Pan is not empty.	Check weighing pan.	Mount correct weighing pan.
MEM FULL	Memory full.	–	Clear the memory by finishing all applications where a measurement is ongoing.
FACTOR OUT OF RANGE	Factor is outside the allow range.	–	Select a new factor.
STEP OUT OF RANGE	Step is outside the allow range.	–	Select a new step.
OUT OF RANGE	Sample weight is outside the allow range.	–	Unload the pan and load a new sample weight.

9.2 Error symptoms

Error symptom	Possible cause	Diagnostic	Remedy
Display is dark	Instrument is switched off.	–	Switch on the instrument.
	Power plug not connected.	Check	Connect power cable to power supply.
	Power supply not connected to balance.	Check	Connect power supply.
	Power supply is faulty.	Check/test	Replace power supply.
	Wrong power supply.	Check that input data on type plate match the power supply values.	Use proper power supply.

Error symptom	Possible cause	Diagnostic	Remedy
	Connector socket on balance is corroded or faulty.	Check	Please contact your METTLER TOLEDO customer service.
	Display is faulty.	Replace display.	Please contact your METTLER TOLEDO customer service.
Membrane keypad does not function	Keypad faulty.	Replace keypad.	Please contact your METTLER TOLEDO-Support representative.
The value drifts into plus or minus	Room, environment not suitable.	–	Environmental recommendations <ul style="list-style-type: none"> • Windowless, non air-conditioned room, e.g., basement. • Only one person in the weighing room. • Sliding doors. Standard doors cause pressure changes. • No draft in weighing room (check with suspended threads). • No air conditioning (temperature oscillates, draft). • Acclimatize balance, take dummy measurements. • Instrument uninterruptedly connected to the power supply (24h per day).
	Direct sunlight or other heat source.	Is any sun shade (blinds, curtains, etc.) available?	Select location according to "Selecting the location" (customer responsibility).
	Weighing sample absorbs moisture or evaporates moisture.	<ul style="list-style-type: none"> • Is the weighing result with a test weight stable? • Sensitive weighing samples, e.g., paper, cardboard, wood, plastic, rubber, liquids. 	<ul style="list-style-type: none"> • Use aids. • Cover weighing sample.
	Weighing sample is electrostatically charged.	<ul style="list-style-type: none"> • Is the weighing result with a test weight stable? • Sensitive weighing samples, e.g., plastic, powder, insulating materials. 	<ul style="list-style-type: none"> • Increase air humidity in weighing chamber (45% - 50%). • Use ionizer.
	Weighing sample is hotter or colder than the air in the weighing chamber.	Weighing operation with test weight does not show this effect.	Bring weighing sample to room temperature before weighing.

Error symptom	Possible cause	Diagnostic	Remedy
	Instrument has not yet reached thermal equilibrium.	<ul style="list-style-type: none"> Was there a power outage? Was power supply disconnected? 	<ul style="list-style-type: none"> Acclimatize instrument for at least 1 hour. Depending on climatic conditions, extend this period accordingly. Instrument switched on for at least 1 hour, refer to "General data"
Display shows overload or underload	The weight on the weighing pan exceeds the weighing capacity of the instrument.	Check weight.	Reduce the weight on the weighing pan.
	Wrong weighing pan.	Slightly lift or press weighing pan. The weight display appears.	Use proper weighing pan.
	No weighing pan.	–	Install weighing pan.
	Incorrect zero point at switch-on.	–	<ul style="list-style-type: none"> Switch off balance. Disconnect and reconnect power cable.
Display flashes 0.00000	Loose cables.	Check all cable connections.	Connect all cables. Please contact your METTLER TOLEDO-Support representative if the problem persists.
Taring not possible	Vibrations at the workplace.	Display unstable.	Press Tare again.
		Place beaker with tap water on the weighing table. Vibrations cause ripples on the water surface.	<ul style="list-style-type: none"> Protect weighing location against vibrations (vibration absorber, etc.). Set weighing parameters coarser (change ENVIRON. from STABLE to STANDARD or even UNSTABLE). Find a different weighing location (by agreement with customer).

9.3 Status icons

Icon	Status description	Diagnostic	Remedy
	Service due.	See menu topic SERV.ICON in chapter "Description of menu topic" -> "Advanced menu".	Please contact your METTLER TOLEDO-Support representative.

9.4 Putting into operation after fixing an error

After fixing an error, perform the following steps to put the balance into operation:

- Ensure that the balance is completely reassembled and cleaned.

- Reconnect the balance to the AC/DC adapter.

10 Technical Data

10.1 General data

Power supply

AC/DC adapter:

Input: 100 – 240 V AC \pm 10%, 50 – 60 Hz, 0.8 A, 60 – 80 VA

Output: 12 V DC, 2.5 A, LPS (Limited Power Source)

Cable for AC/DC adapter:

3-core, with country-specific plug

Polarity:



Balance power consumption:

12 V DC, 0.3 A

Protection and standards

Overvoltage category:

II

Degree of pollution:

2

Protection:

Protected against dust and water

Standards for safety and EMC:

See Declaration of Conformity

Range of application:

Use only indoors in dry locations

Environmental conditions

Height above mean sea level:

Up to 4000 m

Ambient temperature:

+5 °C – +40 °C

Storage condition:

-25 °C – +70 °C

Relative air humidity:

Max. 80% up to 31 °C, linearly decreasing to 50% at 40 °C, non-condensing

Warm-up time:

At least **60 minutes** after connecting the balance to the power supply. When switched on from standby, the instrument is ready for operation immediately.

Materials

Housing/Terminal:

Die-cast aluminum / PA12

Weighing pan:

Stainless steel X2CrNiMo 17-12-2 (1.4404)

Draft shield element:

Stainless steel X2CrNiMo 17-12-2 (1.4404)

Draft shield:

PBT, glass

Protective cover:

PET

10.2 Model-specific data

	MS105	MS105DU	MS205DU
Limit Values			
Maximum capacity	120 g	120 g	220 g
Nominal load	100 g	100 g	200 g
Readability	0.01 mg	0.1 mg	0.1 mg
Maximum capacity in fine range	–	42 g	82 g
Readability in fine range	–	0.01 mg	0.01 mg
Repeatability (at nominal load)	0.04 mg	0.08 mg	0.08 mg
Repeatability (5% load)	0.02 mg	0.02 mg	0.02 mg
Linearity deviation	0.1 mg	0.15 mg	0.2 mg
Eccentricity deviation (test load)	0.3 mg (50 g)	0.3 mg (50 g)	0.3 mg (100 g)
Sensitivity offset (at nominal load) ¹⁾	0.4 mg	0.4 mg	0.8 mg
Sensitivity temperature drift ²⁾	0.0002%/°C	0.0002%/°C	0.0002%/°C
Typical values			
Repeatability (5% load)	0.015 mg	0.015 mg	0.015 mg
Linearity deviation (sd)	0.03 mg	0.05 mg	0.06 mg
Eccentricity deviation (sd) (test load)	0.1 mg (50 g)	0.1 mg (50 g)	0.1 mg (100 g)
Sensitivity offset (at nominal load)	0.2 mg	0.2 mg	0.4 mg
Minimum weight (according to USP, 5% load)	30 mg	30 mg	30 mg
Minimum weight (U=1%, k=2, 5% load)	3 mg	3 mg	3 mg
Settling time	1.5 s	1.5 s	1.5 s
Settling time in fine range	–	3 s	3 s
Dimensions & other specifications			
Balance dimensions (W × D × H)	247 × 358 × 331 mm	247 × 358 × 331 mm	247 × 358 × 331 mm
Weighing pan diameter	80 mm	80 mm	80 mm
Usable height of draft shield	235 mm	235 mm	235 mm
Weight of the balance	6.8 kg	6.8 kg	6.8 kg
Weights for routine testing			
Weights (OIML Class)	5 g (F2) / 100 g (F2)	5 g (F2) / 100 g (F2)	10 g (F2) / 200 g (F2)
Weights (ASTM Class)	5 g (ASTM 1)/ 100 g (ASTM 1)	5 g (ASTM 1)/ 100 g (ASTM 1)	10 g (ASTM 1)/ 200 g (ASTM 1)

sd = standard deviation

¹⁾ offer adjustment with internal weight

²⁾ In the temperature range +10 °C – +30 °C

	MS204
Limit Values	
Maximum capacity	220 g
Nominal load	200 g
Readability	0.1 mg
Maximum capacity in fine range	–
Readability in fine range	–
Repeatability (at nominal load)	0.09 mg
Repeatability (5% load)	0.07 mg
Linearity deviation	0.2 mg
Eccentricity deviation (test load)	0.3 mg (100 g)
Sensitivity offset (at nominal load) ¹⁾	0.8 mg
Sensitivity temperature drift ²⁾	0.0002%/°C
Typical values	
Repeatability (5% load)	0.05 mg
Linearity deviation (sd)	0.06 mg
Eccentricity deviation (sd) (test load)	0.1 mg (100 g)
Sensitivity offset (at nominal load)	0.4 mg
Minimum weight (according to USP, 5% load)	100 mg
Minimum weight (U=1%, k=2, 5% load)	10 mg
Settling time	1.5 s
Settling time in fine range	–
Dimensions & other specifications	
Balance dimensions (W × D × H)	247 × 358 × 331 mm
Weighing pan diameter	80 mm
Usable height of draft shield	235 mm
Weight of the balance	6.8 kg
Weights for routine testing	
Weights (OIML Class)	10 g (F2) / 200 g (F2)
Weights (ASTM Class)	10 g (ASTM 1)/ 200 g (ASTM 1)

sd = standard deviation

¹⁾ after adjustment with internal weight

²⁾ In the temperature range +10 °C – +30 °C

10.3 Dimensions

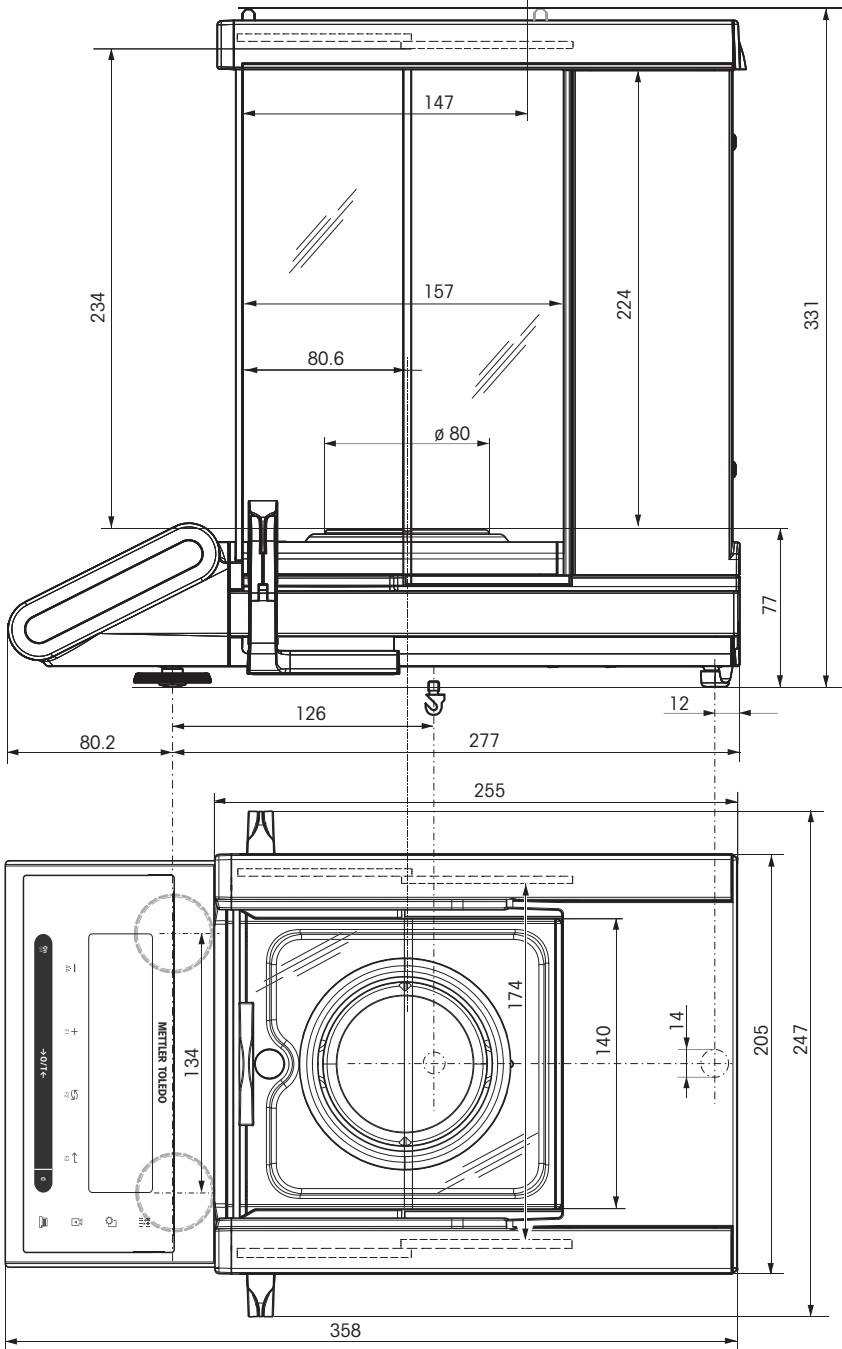

10.4 Interface specification

10.4.1 RS232C interface

Each balance is equipped with a RS232C Interface as standard for the attachment of a peripheral device, e.g., a printer or a computer.

Schematic	Item	Specification
	Interface type	Voltage interface according to EIA RS232C/ DIN66020 CCITT V24/V.28)
	Max. cable length	15 m
	Signal level	Outputs: +5 V ... +15 V (RL = 3–7 kΩ) –5 V ... –15 V (RL = 3–7 kΩ) Inputs: +3 V ... +25 V –3 V ... –25 V
	Connector	Sub-D, 9-pole, female
	Operating mode	Full duplex
	Transmission mode	Bit-serial, asynchronous
	Transmission code	ASCII
	Baud rates	600, 1200, 2400, 4800, 9600, 19200, 38400 (software selectable)
	Bits/parity	7-bit/none, 7-bit/even, 7-bit/odd, 8-bit/none (software selectable)
	Stop bits	1 stop bit
	Handshake	None, XON/XOFF, RTS/CTS (software selectable)
	End-of-line	<CR><LF>, <CR>, <LF> (software selectable)
	Power supply for 2nd display	+ 12 V, max 40 mA (software selectable, 2nd display mode only)

10.4.2 USB device

Each balance is equipped with a USB device interface as standard for the attachment of a peripheral device, e.g. a computer.



Note

This interface is not able to communicate with a printer.

Schematic	Item	Specification										
<table border="1" data-bbox="359 1755 646 1925"> <tr> <td>1</td> <td>VBUS (+5 VDC)</td> </tr> <tr> <td>2</td> <td>D- (Data -)</td> </tr> <tr> <td>3</td> <td>D+ (Data +)</td> </tr> <tr> <td>4</td> <td>GND (Ground)</td> </tr> <tr> <td>Shield</td> <td>Shield</td> </tr> </table>	1	VBUS (+5 VDC)	2	D- (Data -)	3	D+ (Data +)	4	GND (Ground)	Shield	Shield	Standard	In conformity with USB specifications revision 2.0
	1	VBUS (+5 VDC)										
	2	D- (Data -)										
	3	D+ (Data +)										
	4	GND (Ground)										
Shield	Shield											
Speed	Full-speed 12 Mbps (requires shielded cable)											
Function	CDC (Communication Device Class) serial port emulation											
Power usage	Suspended device: Max 10 mA											
Connector	Type B											

10.4.3 Aux connection

You can connect the METTLER TOLEDO "ErgoSens" or an external switch to socket Aux. This allows you to start functions such as taring, zeroing or printing.

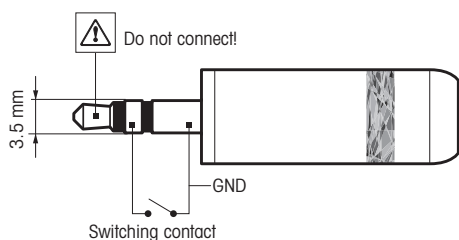

External connection

Connector:
3.5 mm stereo jack connector

Electrical data:
Max. voltage 12 V
Max. current 150 mA

10.4.4 MT-SICS interface commands and functions

Many of the instruments and balances used have to be able to integrate into a complex computer or data acquisition system.

To easily integrate a balance into a system and utilize its capacity to the full extent, most balance functions are also available as corresponding commands via the data interface.

All new METTLER TOLEDO balances launched on the market support "METTLER TOLEDO Standard Interface Command Set" (MT-SICS). The commands available depend on the functionality of the balance.

For further information, please contact your METTLER TOLEDO representative.



Refer to the MT-SICS Reference Manual.

► www.mt.com/library

11 Disposal

In conformance with the European Directive 2012/19/EU on Waste Electrical and Electronic Equipment (WEEE) this device may not be disposed of in domestic waste. This also applies to countries outside the EU, per their specific requirements.







Please dispose of this product in accordance with local regulations at the collecting point specified for electrical and electronic equipment. If you have any questions, please contact the responsible authority or the distributor from which you purchased this device. Should this device be passed on to other parties, the content of this regulation must also be related.



12 Accessories and Spare Parts

12.1 Accessories

	Description	Order no.
Printers		
	RS-P25 printer with RS232C connection to instrument	30702967
	Paper roll (length: 20 m), set of 5 pcs	00072456
	Paper roll (length: 13 m), self-adhesive, set of 3 pcs	11600388
	Ribbon cartridge, black, set of 2 pcs	00065975
	RS-P26/01 (EMEA) printer with RS232C connection to instrument (with date and time)	11124303
	Paper roll (length: 20 m), set of 5 pcs	00072456
	Paper roll, self-adhesive (length: 13 m), set of 3 pcs	11600388
	Ribbon cartridge, black, set of 2 pcs	00065975
	RS-P26/02 (Asia-Pacific) printer with RS232C connection to instrument (with date and time)	11124313
	Paper roll (length: 20 m), set of 5 pcs	00072456
	Paper roll (length: 13 m), self-adhesive, set of 3 pcs	11600388
	Ribbon cartridge, black, set of 2 pcs	00065975
	RS-P26/03 (Northern America) printer with RS232C connection to instrument (with date and time)	11124323
	Paper roll (length: 20 m), set of 5 pcs	00072456
	Paper roll, self-adhesive (length: 13 m), set of 3 pcs	11600388
	Ribbon cartridge, black, set of 2 pcs	00065975
	RS-P28/01 (EMEA) printer with RS232C connection to instrument (with date, time and applications)	11124304
	Paper roll (length: 20 m), set of 5 pcs	00072456
	Paper roll, self-adhesive (length: 13 m), set of 3 pcs	11600388
	Ribbon cartridge, black, set of 2 pcs	00065975
	RS-P28/02 (Asia-Pacific) printer with RS232C connection to instrument (with date, time and applications)	11124314
	Paper roll (length: 20 m), set of 5 pcs	00072456
	Paper roll (length: 13 m), self-adhesive, set of 3 pcs	11600388
	Ribbon cartridge, black, set of 2 pcs	00065975

	RS-P28/03 (Northern America) printer with RS232C connection to instrument (with date, time and applications)	11124324
	Paper roll (length: 20 m), set of 5 pcs	00072456
	Paper roll, self-adhesive (length: 13 m), set of 3 pcs	11600388
	Ribbon cartridge, black, set of 2 pcs	00065975
	P-52RUE dot matrix printer RS232C, USB and Ethernet connections, simple print-outs	30237290
	Paper roll (length: 20 m), set of 5 pcs	00072456
	Paper roll (length: 13 m), self-adhesive, set of 3 pcs	11600388
	Ribbon cartridge, black, set of 2 pcs	00065975
	P-56RUE thermal printer with RS232C, USB and Ethernet connections, simple print-outs, date and time	30094673
	Paper roll, white (length: 27 m), set of 10 pcs	30094723
	Paper roll, white, self-adhesive (length: 13 m), set of 10 pcs	30094724
	P-58RUE thermal printer with RS232C, USB and Ethernet connections, simple print-outs, date and time, label printing, balance applications, e.g., statistics, formulation, totaling	30094674
	Paper roll, white (length: 27 m), set of 10 pcs	30094723
	Paper roll, white, self-adhesive (length: 13 m), set of 10 pcs	30094724
	Paper roll, white, self-adhesive labels (550 labels), set of 6 pcs	30094725
	Dimension of the label 56×18 mm	

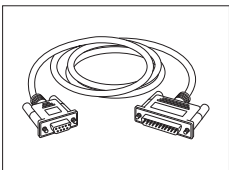
Cables for RS232C interfaces

	RS9 connection cable (to connect the instrument to a PC)	11101051
	Length: 1 m	
	RS9 – RS25 (m/f): connection cable for PC, length = 2 m	11101052
	USB-RS232 cable (to connect the instrument via RS232C to a USB port)	64088427

Cables for USB interface



USB (A –B) connection cable, length = 1 m

30241476

Wireless interfaces



Bluetooth RS232C serial adapter ADP-BT-S

30086494

For wireless connection between:

- instrument and computer (depending on the instrument model)
- printer and instrument



Bluetooth RS232C serial adapter ADP-BT-P, set of 2 pcs

30086495

For wireless connection between:

- Instrument and PC (depending on the instrument model)
- Data writer and instrument

Density determination

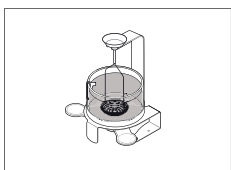

Density Kit Advanced & Standard for balance models with a readability of 0.1 mg / 1 mg

30535760

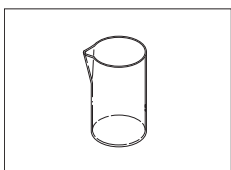

Glass beaker, height 100 mm, \varnothing 60 mm

00238166

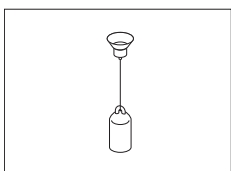

Sinker for density of liquids in conjunction with density kit
Calibrated (sinker + certificate)
Recalibrated (new certificate)

00210260

00210672

00210674

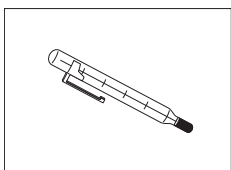

Calibrated thermometer with certificate

11132685

Pipette check



SmartTrap beaker 50 ml*, > 20 - 2000 μ l

30215436

* 50 ml capacity with 0.01 mg readability only in combination with MS105. For other models either readability or capacity is limited.

Auxiliary displays



RS232C auxiliary display AD-RS-M7

12122381

External switches

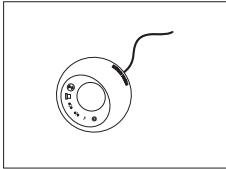

ErgoSens, optical sensor for hands-free operation

11132601

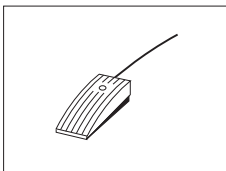

Auxiliary Footswitch with selectable function for balances

11106741

Protective covers

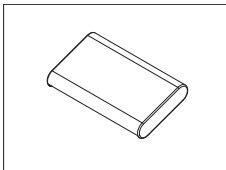

Protective cover for semi micro balances

30006615

Anti-theft devices



Anti-theft cable with lock

11600361

Software

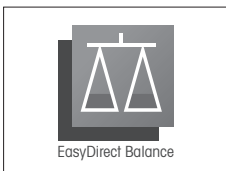

EasyDirect Balance is an application software to collect, analyze, store and export balance measurement and device data on PC.

License EasyDirect Balance for 10 Instruments

30540473

License EasyDirect Balance for 3 Instruments

30539323

Various

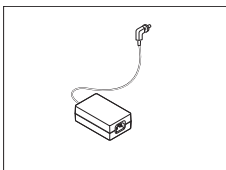

AC/DC adapter (without power cable)

11107909

- Input: 100 – 240 V AC, 50/60 Hz, 0.8 A
- Output: 12 V DC, 2.5 A

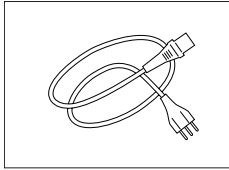

Country-specific 3-Pin power cable with grounding conductor.

Power cable AU	00088751
Power cable BR	30015268
Power cable CH	00087920
Power cable CN	30047293
Power cable DK	00087452
Power cable EU	00087925
Power cable GB	00089405
Power cable IL	00225297
Power cable IN	11600569
Power cable IT	00087457
Power cable JP	11107881
Power cable TH, PE	11107880
Power cable US	00088668
Power cable ZA	00089728

Adjustment weights



OIML / ASTM Weights (with calibration certificate)
see ► www.mt.com/weights

12.2 Spare parts

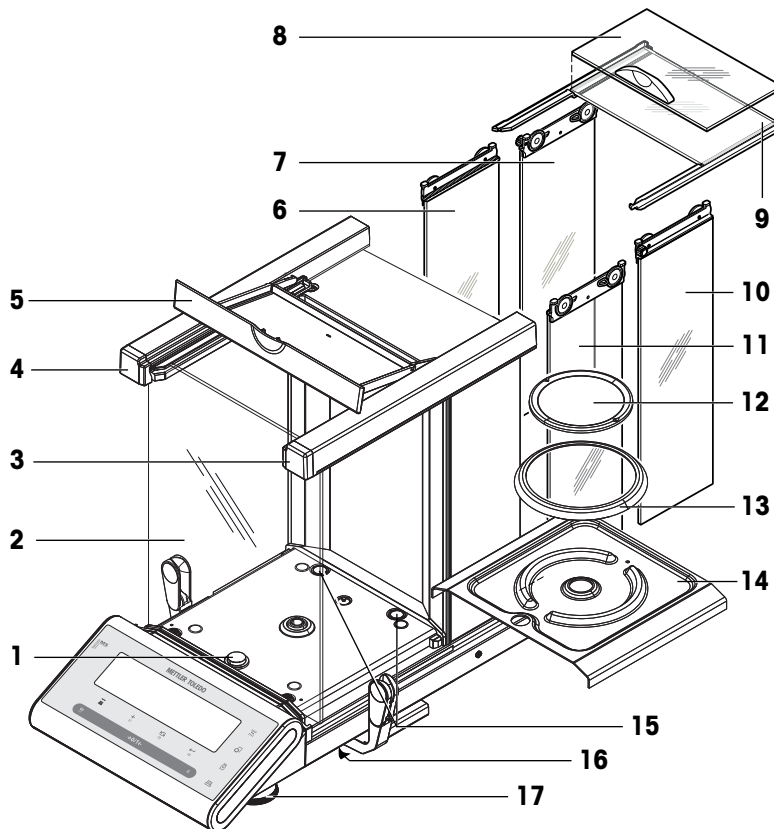

	Order no.	Designation	Remarks
1	11142253	Level cover	–
2	30003679	Front glass panel	–
3	11142229	Front glass lock, right	–
4	11142228	Front glass lock, left	–
5	11142244	Top cover	–
6	30003678	Side door front, left	Including: Handle
7	11133079	Door back left	–
8	11133082	Door top front	Including: handle
9	11133081	Door top back	–
10	11133077	Door back right	–
11	30003677	Side door front, right	Including: Handle
12	30003777	Weighing pan	–
13	11142206	Draft ring	–
14	30003778	Drip tray	–
15	11122623	Plastic cap	–
16	12104936	Weighing below balance cap	–
17	30104835	Leveling feet	Including: 2 leveling feet

Index

A

AC/DC adapter	82
Accessories	89
Adjusting	14
Adjustment	16, 27
Adjustment history	68
Advanced menu	22
altitude	82
Application density	55
Application diagnostics	30, 66
Application formulation	46
Application icons	10
Application multiplication factor weighing	51
Application percent weighing	42
Application piece counting	39
Application pipette check	60
Application routine test	64
Application statistics	44
Application totaling	49
Assign application	29, 30
Auto print	33
Automatic adjustment	15
Automatic shutoff	28
Automatic zero setting	29
Autozero	29
Aux connection	87
Average (Statistics)	44

B

Backlight	28
Balance history	67
Balance information	68
Basic menu	22, 25
Baudrate	34
Beep	26
below-the-balance weighing	21
Bit/Parity	34

C

Calibration	27
Cancel	24
Change settings	24
Char set	31, 35, 38
Cleaning	74
Closing the menu	24

Control limit	65
convention	3
Customer fine adjustment	16, 27

D

Data communication format	33, 36
Date	25
Date format	27
Density	55
Density kit	55, 91
Density of distilled water	59
Density table for ethanol	59
Diagnose	30
Diagnostics	66
Diagnostics application	30
Dimensions	85
Display	28, 32
Display panel	10
Display test	66
disposal	88
Distilled water	59
Dosing	26
Draft shield	12, 74, 75
DualRange	19

E

End of line	35, 37
Environment	26
environmental condition	11, 82
ErgoSens	38, 87
Ethanol	59
External key	38

F

FACT	15, 27
Factor weighing	51
Fill up	47
Foot switch	87
Formulation	46
Fully automatic adjustment	15, 27
Function fill up	47
Function PC-Direct	70

G

Good weighing practice	64
GWP	64, 65

H			
Handshake	35	Motor test	67
Header	32	MT-SICS	87
Host	31, 36	Multiplication factor weighing	51
humidity	82	N	
I		Net	18
Icons	10	Numerical values	24
Input principle	24	O	
install		Operating temperature	13
site	11	Operation keys	8
Installing the components	12	P	
Interface		PC-DIR	31
MT-SICS	87	PC-Direct	70
USB device	86	Percent weighing	42
Interface menu	23, 31	Performing a simple weighing	18
Interface RS232C	31, 86	Piece counting	39
Interface USB device	35	Pipette check	60
Internal weight	15	power supply	82
Interval	38	see AC/DC adapter	82
K		Print	20
Key assign	29, 30	Printer	31
Key beep	26	Protect	25
Key functions	8	Protocol trigger	27
Key test	67	R	
L		Recall	19, 28
Language	29	Repeatability test	66
Level indicator	14	Reset	26
Leveling	13	Routine test	64
Leveling the balance	13	RS232C interface	31, 86
Line feed	32	S	
Liquid	56	safety information	5
Liquids	57	Saving settings	24
location	11	Select menu	23
M		Select menu topic	23
Main menu	24	Service	30, 31, 74
Manual adjustment with internal weight	15	Service date reset	31
materials	82	Service icon	30
Menu	22, 24	Service provider information	69
Menu advanced	22	Service reminder	30
Menu basic	22, 25	Shutoff	20, 28
Menu interface	23, 31	Signature line	32
Menu operation	23	Single	32
Menu protection	25	Sinker	55
Menu topic	23, 24	Solids	56

SOP	65
Stability beep	26
Standard deviation (Statistics)	44
Statistics	44
Status icons	10
Stop bit	35
Submenu	24
Switching weight units	19
symbol	3
warning	5

T

Taring	18
Technical data	82
Technical data dimensions	85
Technical data model-specific	84
temperature	82
warm-up time	82
Time	25
warm up	82
Time format	28
Topic	23, 24
Totaling	49
Transmit data	20
Transport over short distances	20
Transporting the balance	20

U

Unit	25, 26
USB device interface	35, 70, 86
USB driver installing	70

W

warm up	
time	82
Warm-up time	13
Warning limit	65
warning symbol	5
Weighing mode	26
Weighing-in aid	19
Weight unit	19, 25, 26

Z

Zero print	33
Zero range	29
Zero setting	18
Zeroing	29

GWP®

Good Weighing Practice™

GWP® is the global weighing standard, ensuring consistent accuracy of weighing processes, applicable to all equipment from any manufacturer. It helps to:

- Choose the appropriate balance or scale
- Calibrate and operate your weighing equipment with security
- Comply with quality and compliance standards in laboratory and manufacturing

 www.mt.com/GWP

www.mt.com/semimicro-analytical

For more information

Mettler-Toledo GmbH

Im Langacher 44
8606 Greifensee, Switzerland
www.mt.com/contact

Subject to technical changes.
© Mettler-Toledo GmbH 04/2022
11781416I en



11781416