

M400/2(X)H, M400G/2XH

Multi-Parameter Transmitter



METTLER TOLEDO

© It is forbidden to reprint this instruction manual in whole or part.

No part of this manual may be reproduced in any form, or modified, copied or distributed using electronic systems, in particular in the form of photocopies, photographs, magnetic or other recordings, without written consent of Mettler-Toledo GmbH, Process Analytics, CH-8902 Urdorf, Switzerland.

All rights reserved, in particular reproduction, translation and patenting/registration.

ISM is a trademark of the METTLER TOLEDO Group.

Operation Manual

Multi-Parameter Transmitter

M400/2(X)H, M400G/2XH

Content

1	Introduction	9
2	Safety Instructions	10
2.1	Definition of Equipment and Documentation Symbols and Designations	10
2.2	Environmental protection	11
2.3	Ex Instructions for M400 Series Multi-Parameter Transmitters – ATEX/IECEX/UKCA	12
2.4	Ex Instructions for M400 Series Multi-Parameter Transmitters – FM Approval	14
2.4.1	Instructions of Use to Be Considered under FM Approval	14
2.4.1.1	General Notes	16
2.4.1.2	Cautionary Notes, Warnings and Markings	16
2.4.1.3	Control Drawings	18
3	Unit Overview	19
3.1	Overview ½ DIN	19
3.2	Control/Navigation Keys	20
3.2.1	Menu Structure	20
3.2.2	Navigation keys	20
3.2.2.1	Navigating the Menu Tree	20
3.2.2.2	Escape	21
3.2.2.3	ENTER	21
3.2.2.4	Menu	21
3.2.2.5	Calibration Mode	21
3.2.2.6	Info Mode	21
3.2.3	Navigation of Data Entry Fields	21
3.2.4	Entry of Data Values, Selection of Data Entry Options	21
3.2.5	Navigation with ↑ in Display	22
3.2.6	"Save Changes" Dialog	22
3.2.7	Security Passwords	22
3.2.8	Display	22
4	Installation Instruction	23
4.1	Unpacking and Inspection of Equipment	23
4.1.1	Panel Cutout Dimensional Information – ½ DIN models	23
4.1.2	Installation Procedure	24
4.1.3	Assembly – ½ DIN Version	24
4.1.4	½ DIN Version – Dimension Drawings	25
4.1.5	½ DIN Version – Pipe Mounting	25
4.2	Connection of Power Supply	26
4.2.1	Housing (Wall Mount)	26
4.3	Terminal Block (TB) Definitions	27
4.4	Terminal Block TB1	27
4.5	Terminal Block TB2: Analog Sensors	28
4.5.1	Conductivity (2-e/4-e) Analog Sensors	28
4.5.2	pH and Redox (ORP) Analog Sensors	28
4.5.3	Amperometric Oxygen Analog Sensors	29
4.6	Terminal Block TB2: ISM Sensors	29
4.6.1	pH, Amperometric Oxygen, Conductivity (4-e) and Dissolved Carbon Dioxide ISM Sensors	29
4.6.2	Optical Oxygen ISM Sensors	30
4.7	Connection of ISM Sensors	31
4.7.1	Connection of ISM Sensors for pH/ORP, Conductivity 4-e and Amperometric Oxygen Measurement	31
4.7.2	TB2 – AK9 Cable Assignment	31
4.8	Connection of Analog Sensors	32
4.8.1	Connection of Analog Sensor for pH/ORP	32
4.8.2	TB2 – Typical Wiring for Analog pH/ORP Sensor	33
4.8.2.1	Example 1	33
4.8.2.2	Example 2	34
4.8.2.3	Example 3	35
4.8.2.4	Example 4	36
4.8.3	Connection of Analog Sensor for Amperometric Oxygen Measurement	37
4.8.4	TB2 – Typical Wiring for Analog Sensor for Amperometric Oxygen Measurement	38
5	Placing Transmitter in, or Out of Service	39
5.1	Placing Transmitter in Service	39
5.2	Placing Transmitter Out of Service	39

6	Quick Setup	40
7	Sensor Calibration	41
7.1	Enter Calibration Mode	41
7.1.1	Select the Desired Sensor Calibration Task	41
7.1.2	Finish Calibration	42
7.2	Conductivity Calibration for Two- or Four-Electrode Sensors	43
7.2.1	One-Point Sensor Calibration	43
7.2.2	Two-Point Sensor Calibration (Four Electrode Sensors Only)	44
7.2.3	Process Calibration	45
7.3	Calibration of Amperometric Oxygen Sensors	45
7.3.1	One-Point Calibration for Amperometric Oxygen Sensors	46
7.3.1.1	Auto Mode	46
7.3.1.2	Manual Mode	47
7.3.2	Process Calibration for Amperometric Oxygen Sensors	47
7.4	Calibration of Optical Oxygen Sensors (Only for ISM Sensors)	48
7.4.1	One-Point Calibration for Optical Oxygen Sensors	48
7.4.1.1	Auto Mode	49
7.4.1.2	Manual Mode	49
7.4.2	Two-Point Sensor Calibration	49
7.4.2.1	Auto Mode	50
7.4.2.2	Manual Mode	50
7.4.3	Process Calibration	51
7.5	pH Calibration	52
7.5.1	One Point Calibration	52
7.5.1.1	Auto Mode	52
7.5.1.2	Manual Mode	53
7.5.2	Two-Point Calibration	53
7.5.2.1	Auto Mode	53
7.5.2.2	Manual Mode	54
7.5.3	Process Calibration	54
7.5.4	mV Calibration (Only for Analog Sensors)	55
7.5.5	ORP Calibration (Only for ISM Sensors)	55
7.6	Carbon Dioxide Calibration (Only for ISM Sensors)	56
7.6.1	One-Point Calibration	56
7.6.1.1	Auto Mode	56
7.6.1.2	Manual Mode	57
7.6.2	Two-Point Calibration	57
7.6.2.1	Auto Mode	57
7.6.2.2	Manual Mode	58
7.6.3	Process Calibration	58
7.7	Sensor Temperature Calibration (Only for Analog Sensors)	59
7.7.1	One-Point Sensor Temperature Calibration	59
7.7.2	Two-Point Sensor Temperature Calibration	59
7.8	Edit Sensor Calibration Constants (Only for Analog Sensor)	60
7.9	Sensor Verification	60
8	Configuration	61
8.1	Enter Configuration Mode	61
8.2	Measurement	61
8.2.1	Channel Setup	61
8.2.1.1	Analog Sensor	62
8.2.1.2	ISM Sensor	62
8.2.1.3	Save Changes of the Channel Setup	63
8.2.2	Temperature Source (Only for Analog Sensors)	63
8.2.3	Parameter Related Settings	63
8.2.3.1	Conductivity Temperature Compensation	64
8.2.3.2	Concentration Table	65
8.2.3.3	pH/ORP Parameters	66
8.2.3.4	Parameters for Oxygen Measurement Based on Amperometric Sensors	67
8.2.3.5	Parameters for Oxygen Measurement Based on Optical Sensors	68
8.2.3.6	Adjusting Sampling Rate for Optical Sensors	69
8.2.3.7	LED Mode	70
8.2.3.8	Dissolved Carbon Dioxide Parameters	70
8.2.4	Set Averaging	71
8.3	Analog Outputs	72

8.4	Set Points	73
8.5	Alarm/Clean	74
8.5.1	Alarm	75
8.5.2	Clean	76
8.6	ISM Set Up (Available for pH and Oxygen ISM Sensors)	77
8.6.1	Sensor Monitoring	77
8.6.2	CIP Cycle Limit	78
8.6.3	SIP Cycle Limit	79
8.6.4	Autoclaving Cycle Limit	79
8.6.5	Reset ISM Counter/Timer	80
8.6.6	DLI Stress Adjustment (Only for pH ISM Sensors)	80
8.7	Display	81
8.7.1	Measurement	81
8.7.2	Resolution	82
8.7.3	Backlight	82
8.7.4	Name	82
8.7.5	ISM Sensor Monitoring (Available When ISM Sensor Connected)	83
8.8	Hold Analog Outputs	83
9	System	84
9.1	Set Language	84
9.2	Passwords	84
9.2.1	Changing Passwords	85
9.2.2	Configuring Menu Access for Operator	85
9.3	Set/Clear Lockout	85
9.4	Reset	85
9.4.1	Reset System	86
9.4.2	Reset Meter Calibration	86
9.4.3	Reset Analog Calibration	86
9.5	Set Date & Time	86
10	PID Setup	87
10.1	Enter PID Setup	88
10.2	PID Auto/Manual	88
10.3	Mode	88
10.3.1	PID Mode	89
10.4	Tune Parameters	90
10.4.1	PID Assignment & Tuning	90
10.4.2	Setpoint & Deadband	90
10.4.3	Proportional Limits	90
10.4.4	Corner Points	90
10.5	PID Display	91
11	Service	92
11.1	Diagnostics	92
11.1.1	Model/Software Revision	92
11.1.2	Digital Input	92
11.1.3	Display	93
11.1.4	Keypad	93
11.1.5	Memory	93
11.1.6	Set OC	93
11.1.7	Read OC	94
11.1.8	Set Analog Outputs	94
11.1.9	Read Analog Outputs	94
11.2	Calibrate	94
11.2.1	Calibrate Meter (Only for Channel A)	95
11.2.1.1	Temperature	95
11.2.1.2	Current	95
11.2.1.3	Voltage	96
11.2.1.4	Rg Diagnostic	96
11.2.1.5	Rr Diagnostic	97
11.2.1.6	Calibrate Analog Output Signals	97
11.2.2	Calibrate Unlock	98
11.3	Tech Service	98

12	Info	99
12.1	Messages	99
12.2	Calibration Data	99
12.3	Model/Software Revision	100
12.4	ISM Sensor Info (Available When ISM Sensor Connected)	100
12.5	ISM Sensor Diagnostics (Available When ISM Sensor Connected)	100
13	Maintenance	103
13.1	Front Panel Cleaning	103
14	Troubleshooting	104
14.1	Cond (Resistive) Error Messages/Warning- and Alarm List for Analog Sensors	104
14.2	Cond (Resistive) Error Messages/Warning- and Alarm List for ISM Sensors	105
14.3	pH Error Messages/Warning- and Alarm List	105
14.3.1	pH Sensors Except Dual Membrane pH Electrodes	105
14.3.2	Dual Membrane pH Electrodes (pH/pNa)	106
14.3.3	ORP Messages	106
14.4	Amperometric O ₂ Error Messages/Warning- and Alarm List	107
14.4.1	High Level Oxygen Sensors	107
14.4.2	Low Level Oxygen Sensors	107
14.4.3	Trace Oxygen Sensors	108
14.5	Optical O ₂ Error Messages/Warning- and Alarm List	108
14.6	Dissolved Carbon Dioxide Error Messages/Warning- and Alarm List	109
14.7	Warning- and Alarm Indication on the Display	110
14.7.1	Warning Indication	110
14.7.2	Alarm Indication	110
15	Accessories and Spare Parts	111
16	Specifications	112
16.1	General Specifications	112
16.2	Electrical Specifications	116
16.2.1	General Electrical Specifications	116
16.2.2	4 to 20 mA (with HART®)	116
16.3	Mechanical Specifications	116
16.4	Environmental Specifications	117
16.5	Control Drawings	118
16.5.1	Installation, Maintenance and Inspection	118
16.5.2	Control Installation Drawing General Installation	119
16.5.3	Notes	122
17	Default Table	123
18	Warranty	128
19	Buffer Tables	129
19.1	Standard pH Buffers	129
19.1.1	Mettler-9	129
19.1.2	Mettler-10	130
19.1.3	NIST Technical Buffers	130
19.1.4	NIST Standard Buffers (DIN and JIS 19266: 2000-01)	131
19.1.5	Hach Buffers	131
19.1.6	Ciba (94) Buffers	132
19.1.7	Merck Titrisole, Riedel-de-Haën Fixanale	132
19.1.8	WTW Buffers	133
19.1.9	JIS Z 8802 Buffers	133
19.2	Dual Membrane pH Electrode Buffers	134
19.2.1	Mettler-pH/pNa Buffers (Na+ 3.9M)	134

1 Introduction

Statement of Intended Use – The 2-wire M400 multi-parameter transmitter is a single-channel online process instrument with HART® communication capabilities for measuring various properties of fluids and gases. These include Conductivity, Dissolved Oxygen, and pH/ORP. The M400 is available in two different levels. The level indicates the supported measurement parameters which can be covered. The parameters are indicated on the label on the back of the system.

The M400 is a mixed mode transmitter who can handle conventional sensors (analog) or ISM™ sensors (digital).

M400 parameter fit guide

	M400/2H, M400/2XH		M400G/2XH	
	Analog	ISM	Analog	ISM
pH/ORP	•	•	•	•
pH/pNa	–	•	–	•
Conductivity 2-e	•	–	•	–
Conductivity 4-e	•	•	•	•
Amp. DO ppm/ppb/trace	• / • / •	• / • / •	• / • / •	• / • / •
Amp. O ₂ gas	–	–	•	•
Optical oxygen ppm/ppb	–	• / •	–	• / •
Dissolved carbon dioxide (low)	–	•	–	•

A large four line backlit Liquid Crystal Display conveys measuring data and setup information. The menu structure allows the operator to modify all operational parameters by using keys on the front panel. A menu-lockout feature, with password protection, is available to prevent the unauthorized use of the meter. The M400 multi-parameter transmitter can be configured to use its two analog and/or two open collector (OC) outputs for process control.

This description corresponds to the firmware release, version 1.1.03 for transmitter M400/2(X)H and M400G/2XH. Changes are taking place constantly, without prior notification.

2 Safety Instructions

This manual includes safety information with the following designations and formats.

2.1 Definition of Equipment and Documentation Symbols and Designations



WARNING: POTENTIAL FOR PERSONAL INJURY.



CAUTION: possible instrument damage or malfunction.



NOTE: Important operating information.



On the transmitter or in this manual text indicates: Caution and/or other possible hazard including risk of electric shock (refer to accompanying documents)

The following is a list of general safety instructions and warnings. Failure to adhere to these instructions can result in damage to the equipment and/or personal injury to the operator.

- The M400 Transmitter should be installed and operated only by personnel familiar with the transmitter and who are qualified for such work.
- The M400 Transmitter must only be operated under the specified operating conditions (see section 16 “Specifications”).
- Repair of the M400 Transmitter must be performed by authorized, trained personnel only.
- With the exception of routine maintenance, cleaning procedures or fuse replacement, as described in this manual, the M400 Transmitter must not be tampered with or altered in any manner.
- METTLER TOLEDO accepts no responsibility for damage caused by unauthorized modifications to the transmitter.
- Follow all warnings, cautions, and instructions indicated on and supplied with this product.
- Install equipment as specified in this instruction manual. Follow appropriate local and national codes.
- Protective covers must be in place at all times during normal operation.
- If this equipment is used in a manner not specified by the manufacturer, the protection provided by it against hazards may be impaired.



WARNINGS: Installation of cable connections and servicing of this product require access to shock hazard voltage levels. Main power and OC contacts wired to separate power source must be disconnected before servicing.

Switch or circuit breaker shall be in close proximity to the equipment and within easy reach of the OPERATOR; it shall be marked as the disconnecting device for the equipment. Main power must employ a switch or circuit breaker as the disconnecting device for the equipment. Electrical installation must be in accordance with the National Electrical Code and/or any other applicable national or local codes.

 **NOTE: PROCESS UPSETS** Because process and safety conditions may depend on consistent operation of this transmitter, provide appropriate means to maintain operation during sensor cleaning, replacement or sensor or instrument calibration.

 **NOTE:** This is a 2-wire-product with two active 4–20 mA analog output.

2.2 Environmental protection



Waste electrical products should not be disposed of with household waste. Please recycle where facilities exist. Check with your Local Authority or retailer for recycling advice.

2.3 Ex Instructions for M400 Series Multi-Parameter Transmitters – ATEX/IECEX/UKCA

M400 series multi-parameter transmitters are produced by Mettler-Toledo GmbH. It has passed the inspection of IECEx and conforms to following standards:

- **IEC 60079-0 : 2017**
Edition: 7.0 Explosive atmospheres –
Part 0: General requirements
- **IEC 60079-11 : 2011**
Edition: 6.0 Explosive atmospheres –
Part 11: Equipment protection by intrinsic safety “i”

Ex Marking:

- **Ex ib [ia Ga] IIC T4 Gb**
- **Ex ib [ia Da] IIIC T80 °C Db IP66**

Certificate No.:

- **IECEX NEP 18.0007X**
- **SEV 12 ATEX 0132X**
- **CML 22 UKEX 2209X**

1. Special Conditions of use (X-marking in the Certificate Number):

1. Avoid ignition hazard due to impact or friction, prevent mechanical sparks.
2. Avoid electrostatic discharge on enclosure surface, use wet cloth only for cleaning.
3. In hazardous area, IP66 cable glands (as supplied) must be mounted.

2. Pay particular attention to the following when using the transmitter:

1. Rated ambient temperature range:
 - for gas atmosphere: – 20 ~ + 60 °C
 - for dust atmosphere: – 20 ~ + 57 °C
2. No operation on the upgrade interface in hazardous area.
3. Users shall not arbitrarily replace the internal electrical components.
4. When installation, use and maintenance, IEC 60079-14 should be observed.
5. When installation in explosive dust atmosphere
 - 5.1. Cable gland or blanking plug to IEC 60079-0:2017 and IEC 60079-11:2011 with marking Ex ia IIIC IP66 should be adopted.
 - 5.2. The overlay switch of multi-parameter transmitter shall be protected from light.
 - 5.3. Avoid high risk of mechanical danger on the overlay switch.
6. Observe the warning: potential electrostatic charging hazard- see instructions, avoid ignition hazard due to impact or friction for Ga application.
7. For connection to intrinsically safe circuits, use the maximum values in the following table.

Terminal	Function	Safety Parameters				
10, 11	Aout1	$U_i = 30 \text{ V}$	$I_i = 100 \text{ mA}$	$P_i = 0.8 \text{ W}$	$L_i \approx 0$	$C_i = 15 \text{ nF}$
12, 13	Aout2	$U_i = 30 \text{ V}$	$I_i = 100 \text{ mA}$	$P_i = 0.8 \text{ W}$	$L_i \approx 0$	$C_i = 15 \text{ nF}$
1, 2, 3, 4	Digital Input	$U_i = 30 \text{ V}$	$I_i = 100 \text{ mA}$	$P_i = 0.8 \text{ W}$	$L_i \approx 0$	$C_i \approx 0$
6, 7, 8, 9	OC Output	$U_i = 30 \text{ V}$	$I_i = 100 \text{ mA}$	$P_i = 0.8 \text{ W}$	$L_i \approx 0$	$C_i \approx 0$
P,Q	Analog Input	$U_i = 30 \text{ V}$	$I_i = 100 \text{ mA}$	$P_i = 0.8 \text{ W}$	$L_i \approx 0$	$C_i = 15 \text{ nF}$
N, O	RS485 Sensor	$U_i = 30 \text{ V}$ $U_o = 5.88 \text{ V}$	$I_i = 100 \text{ mA}$ $I_o = 54 \text{ mA}$	$P_i = 0.8 \text{ W}$ $P_o = 80 \text{ mW}$	$L_i \approx 0$ $L_o = 1 \text{ mH}$	$C_i = 0.7 \text{ }\mu\text{F}$ $C_o = 1.9 \text{ }\mu\text{F}$
A, E, G	pH Sensor	$U_o = 5.88 \text{ V}$	$I_o = 1.3 \text{ mA}$	$P_o = 1.9 \text{ mW}$	$L_o = 5 \text{ mH}$	$C_o = 2.1 \text{ }\mu\text{F}$
B, A, E, G	Conductivity Sensor	$U_o = 5.88 \text{ V}$	$I_o = 29 \text{ mA}$	$P_o = 43 \text{ mW}$	$L_o = 1 \text{ mH}$	$C_o = 2.5 \text{ }\mu\text{F}$
K, J, I	Temperature Sensor	$U_o = 5.88 \text{ V}$	$I_o = 5.4 \text{ mA}$	$P_o = 8 \text{ mW}$	$L_o = 5 \text{ mH}$	$C_o = 2 \text{ }\mu\text{F}$
H, B, D	Dissolved Oxygen Sensor	$U_o = 5.88 \text{ V}$	$I_o = 29 \text{ mA}$	$P_o = 43 \text{ mW}$	$L_o = 1 \text{ mH}$	$C_o = 2.5 \text{ }\mu\text{F}$
L	One-wire Sensor	$U_o = 5.88 \text{ V}$	$I_o = 22 \text{ mA}$	$P_o = 32 \text{ mW}$	$L_o = 1 \text{ mH}$	$C_o = 2.8 \text{ }\mu\text{F}$

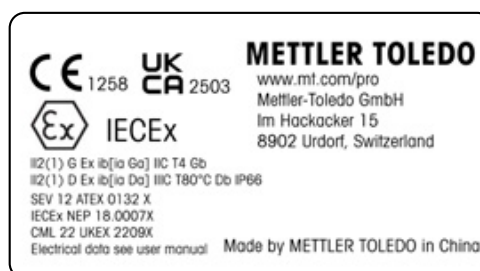
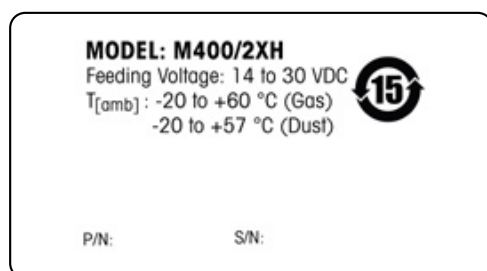

Label Model M400/2XH, M400G/2XH

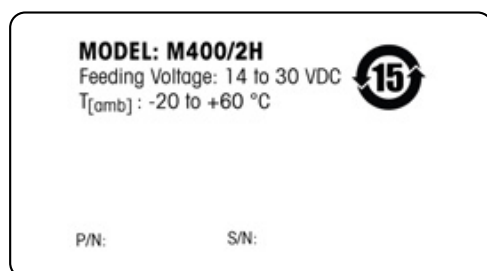

Label Model M400/2H

2.4 Ex Instructions for M400 Series Multi-Parameter Transmitters – FM Approval

2.4.1 Instructions of Use to Be Considered under FM Approval



M400 series multi-parameter transmitters are produced by Mettler-Toledo GmbH. It has passed the inspection of NRTL cFMus and to following requirements: The equipment is provided with an internal bond wiring and an internal flying lead wire for grounding purposes.

US marking

Operating temperature range	– 20 °C to + 60 °C (– 4 °F to + 140 °F)
Environmental designation	Enclosure type 4X, IP66
Intrinsically safe	<ul style="list-style-type: none"> • Class I, Division 1, Groups A, B, C, D T4A • Class II, Division 1, Groups E, F, G • Class III
Intrinsically safe	Class I, Zone 0, AEx ia IIC T4 Ga
Parameters	<ul style="list-style-type: none"> • Entity: Control drawing 12112601 and 12112602 • FISCO: Control drawing 12112603 and 12112602
Nonincendive	<ul style="list-style-type: none"> • Class I, Division 2, Groups A, B, C, D T4A • Class I, Zone 2, Groups IIC T4
Certificate no.	3046275
Standards	<ul style="list-style-type: none"> • FM3810:2005 Approval Standard for Electrical Equipment for Measurement, Control and Laboratory Use • ANSI/IEC-60529:2004 Degrees of Protection Provided by Enclosures (IP Codes) • ANSI/ISA-61010-1:2004 Edition: 3.0 Safety Requirements for Electrical Equipment for Measurement, Control, and Laboratory Use – Part 1: General Requirements • ANSI/NEMA 250:1991 Enclosures for Electrical Equipment (1,000 Volts Maximum) • FM3600:2011 Approval Standard for Electrical Equipment for Use in Hazardous (Classified) Locations – General Requirements • FM3610:2010 Approval Standard for Intrinsically Safe Apparatus and Associated Apparatus for Use in Class I, II & III, Division 1, Hazardous (Classified) Locations • FM3611:2004 Approval Standard for Nonincendive Electrical Equipment for Use in Class I & II, Division 2, and Class III, Division 1 & 2, Hazardous (Classified) Locations • ANSI/ISA-60079-0:2013 Edition: 6.0 Explosive Atmospheres – Part 0: General Requirements • ANSI/ISA-60079-11:2012 Edition: 6.0 Explosive Atmospheres – Part 11: Equipment Protection by Intrinsic Safety “i”

Canadian marking

Operating temperature range	– 20 °C to + 60 °C (– 4 °F to + 140 °F)
Environmental designation	Enclosure type 4X, IP66
Intrinsically safe	<ul style="list-style-type: none"> • Class I, Division 1, Groups A, B, C, D T4A • Class II, Division 1, Groups E, F, G • Class III
Intrinsically safe	Class I, Zone 0, Ex ia IIC T4 Ga
Parameters	<ul style="list-style-type: none"> • Entity: Control drawing 12112601 and 12112602 • FISCO: Control drawing 12112603 and 12112602
Nonincendive	Class I, Division 2, Groups A, B, C, D T4A
Certificate no.	3046275
Standards	<ul style="list-style-type: none"> • CAN/CSA-C22.2 No. 60529:2010 Degrees of Protection Provided by Enclosures (IP Codes) • CAN/CSA-C22.2 No. 61010-1:2004 Edition: 3.0 Safety Requirements for Electrical Equipment for Measurement, Control, and Laboratory Use – Part 1: General Requirements • CAN/CSA-C22.2 No. 94:1976 Special Purpose Enclosures – Industrial Products • CAN/CSA-C22.2 No. 213-M1987:2013 Non-Incendive Equipment for Use in Class I, Division 2 Hazardous Locations – Industrial Products • CAN/CSA-C22.2 No. 60079-0:2011 Edition: 2.0 Explosive Atmospheres – Part 0: General Requirements • CAN/CSA-C22.2 No. 60079-11:2014 Edition: 2.0 Explosive Atmospheres – Part 11: Equipment Protection by Intrinsic Safety “i”

2.4.1.1 General Notes

The Multi-parameter Transmitter M400/2(X)H, M400G/2XH, M400FF, M400PA are suitable for use in hazardous atmospheres of all combustible materials of explosion groups A, B, C, D, E, F and G for applications requiring Class I, II, III, Division 1 instruments and groups A, B, C and D for applications requiring Class I, Division 2 instruments (National Electrical Code® (ANSI/NFPA 70 (NEC®), Article 500; or Canadian Electrical (CE) Code® (CEC Part 1, CAN/CSA-C22.1), Appendix F when installed in Canada), or of explosion groups IIC, IIB or IIA for applications requiring Class I, Zone 0, AEx/Ex ia IIC T4, Ga instruments (National Electrical Code® (ANSI/NFPA 70 (NEC®), Article 500; or Canadian Electrical (CE) Code® (CEC Part 1, CAN/CSA-C22.1), Appendix F when installed in Canada).

If the Multi-parameter Transmitter M400/2(X)H, M400G/2XH, M400FF, M400PA is installed and operated in hazardous areas, the general Ex installation regulations as well as these safety instructions must be observed.

The operating instructions as well as the installation regulations and standards that apply for explosion protection of electrical systems must always be observed.

The installation of explosion-endangered systems must always be carried out by qualified personnel.

For mounting instructions on specific valves refer to the mounting instructions supplied with the mounting kit. Mounting does not affect the suitability of the SVI FF positioner for use in a potentially hazardous environment.

The equipment is not intended to be used as personal protective equipment. To prevent injury, read the manual before use.

For language translation assistance contact your local representative or email process.service@mt.com.

Pour la langue de traduction aide, contactez votre représentant local ou envoyez un e-mail process.service@mt.com.

2.4.1.2 Cautionary Notes, Warnings and Markings

Hazardous location notes:

1. For guidance on US installations, see ANSI/ISA-RP12.06.01, Installation of Intrinsically Safe Systems for Hazardous (Classified) Locations.
2. Installations in the US shall comply with the relevant requirements of the National Electrical Code® (ANSI/NFPA 70 (NEC®)).
3. Installations in Canada shall comply with the relevant requirements of the Canadian Electrical (CE) Code® (CEC Part 1, CAN/CSA-C22.1).
4. Wiring methods must conform to all local and national codes governing the installation, and wiring must be rated for at least +10 °C above the highest expected ambient temperature.
5. Where the protection type allows and depends on wiring glands, the glands must be certified for the type of protection required and area classification identified on the equipment or system nameplate.
6. The internal grounding terminal shall be used as the primary equipment grounding means and the external grounding terminal is only for a supplemental (secondary) bonding connection where local authorities permit or require such a connection.

7. A dust-tight conduit seal shall be used when installed in Class II conductive and non-conductive dust environments and Class III combustible flyings environments.
8. Approved seals against ingress of water or dust are required and the NPT or metric thread fittings must be sealed with tape or thread sealant in order to meet the highest level of ingress protection.
9. When the equipment is supplied with plastic dust plugs in the conduit/cable gland entries; it is the end-user's responsibility to provide cable glands, adaptors and/or blanking plugs suitable for the environment in which the equipment is installed. When installed in a hazardous (classified) location, the cable glands, adaptors and/or blanking plugs shall additionally be suitable for the hazardous (classified) location, the product certification, and acceptable to the local authority having jurisdiction for the installation.
10. The end-user must consult the manufacturer for repair disclaimers, and only certified parts, such as entry plugs, mounting and cover lock screws and gaskets, supplied by the manufacturer are permitted. No substitutions with non-manufacturer supplied parts are permitted.
11. Tighten cover screws to 1.8 Nm (15.8 lb-in.). Overtorquing may cause enclosure breakage.
12. The minimum tightening torque for M4 (No. 6) binding screw protective conductor terminals is 1.2 Nm (10.6 lb-in.) or greater, as specified.
13. Care must be taken during installation to avoid impacts or friction that could create an ignition source.
14. Use copper, copper-clad aluminum or aluminum conductors only.
15. The recommended tightening torque for field wiring terminals is 0.8 Nm (7 lb-in.) or greater, as specified.
16. The Nonincendive version of the Multi-parameter Transmitter M400/2H must be connected to limited output NEC Class 2 circuits, as outlined in the National Electrical Code® (ANSI/NFPA 70 (NEC®)), only. If the devices are connected to a redundant power supply (two separate power supplies), both must meet this requirement.
17. The Class I, Zone 2 certifications are based on Division evaluations and the marking acceptance of Article 505 of the National Electrical Code® (ANSI/NFPA 70 (NEC®)).
18. The Multi-parameter Transmitter M400/2(X)H, M400G/2XH, M400FF, M400PA assessed were certified by FM Approvals under a Type 3 Certification System as identified in ISO Guide 67.
19. Tampering and replacement with non-factory components may adversely affect the safe use of the system.
20. Insertion or withdrawal of removable electrical connectors is to be accomplished only when the area is known to be free of flammable vapors.
21. The Multi-parameter Transmitter M400/2(X)H, M400G/2XH, M400FF, M400PA is not intended for servicing or maintenance operation. Malfunctioning units operating out of manufacturer's specification should be discarded and replaced with a new operational unit.
22. Substitution of components may impair intrinsic safety.
23. Do not open when an explosive atmosphere is present.
24. Explosion hazard, do not disconnect while circuit is live unless area is known to be non-hazardous.
25. Explosion hazard, substitution of components may impair suitability for Class I, Division 2.

The Multi-parameter Transmitter M400/2XH, M400G/2XH intrinsically safe apparatus, entity version, bears the following label marking:



Label Model M400/2XH, M400G/2XH

The Multi-parameter Transmitter M400/2H nonincendive version, bears the following label marking:



Label Model M400/2H

2.4.1.3 Control Drawings

Refer to section 16.5 "Control Drawings" on Page 18.

3 Unit Overview

The M400 models are available in ½ DIN case size. The M400 models provide an integral IP66/NEMA4X housing for wall- or pipe mount.

3.1 Overview ½ DIN

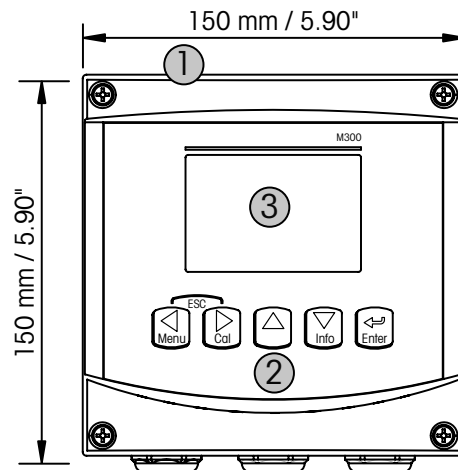

- 1: Hard Polycarbonate case
- 2: Five Tactile-Feedback Navigation Keys
- 3: Four-line LC Display

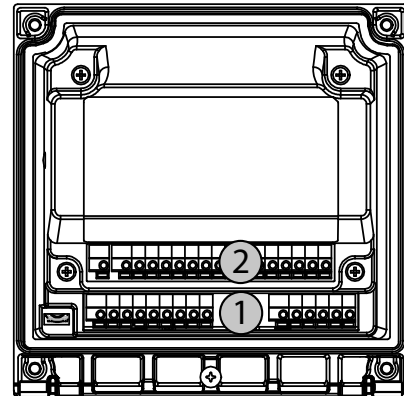

- 1: TB1 – Input and Output Analog Signal
- 2: TB2 – Sensor Signal

3.2 Control/Navigation Keys

3.2.1 Menu Structure

Below is the structure of the M400 menu tree:

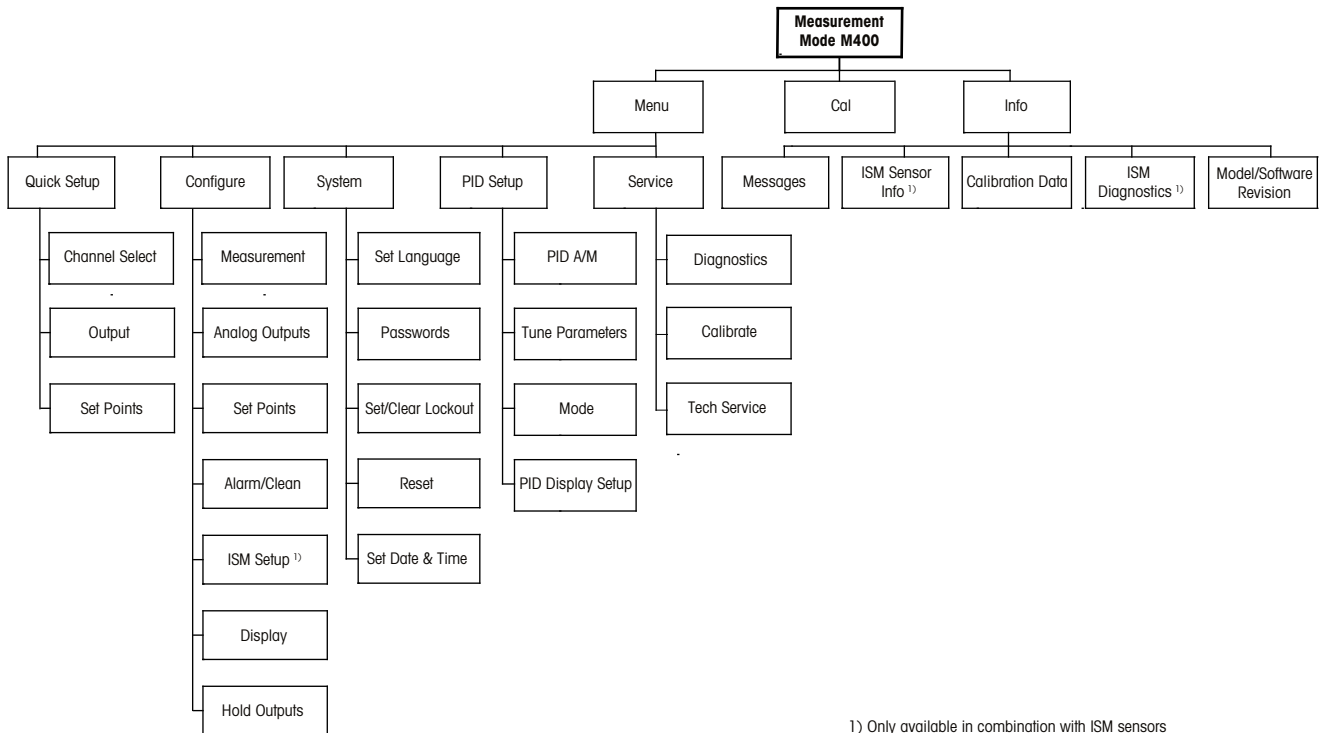

3.2.2 Navigation keys



3.2.2.1 Navigating the Menu Tree

Enter the desired main Menu branch with the ◀▶ or ▲ keys. Use the ▲ and ▼ keys to navigate through the selected Menu branch.



NOTE: In order to back up one menu page, without escaping to the measurement mode, move the cursor under the UP Arrow character (↑) at the bottom right of the display screen and press [ENTER].

3.2.2.2 Escape

Press the ◀ and ▶ key simultaneously (escape) to return to the Measurement mode.

3.2.2.3 ENTER

Use the ↵ key to confirm action or selections.

3.2.2.4 Menu

Press the ◀ key to access the main Menu.

3.2.2.5 Calibration Mode

Press the ▶ key to enter Calibration mode.

3.2.2.6 Info Mode

Press the ▼ key to enter Info mode.

3.2.3 Navigation of Data Entry Fields

Use the ▶ key to navigate forward or the ◀ key to navigate backwards within the changeable data entry fields of the display.

3.2.4 Entry of Data Values, Selection of Data Entry Options

Use the ▲ key to increase or the ▼ key to decrease a digit. Use the same keys to navigate within a selection of values or options of a data entry field.



NOTE: Some screens require configuring multiple values via the same data field (ex: configuring multiple setpoints). Be sure to use the ▶ or ◀ key to return to the primary field and the ▲ or ▼ key to toggle between all configuration options before entering to the next display screen.

3.2.5 Navigation with ↑ in Display

If a ↑ is displayed on the bottom right hand corner of the display, you can use the ► or the ◀ key to navigate to it. If you click [ENTER] you will navigate backwards through the menu (go back one screen). This can be a very useful option to move back up the menu tree without having to exit into the measuring mode and re-enter the menu.



3.2.6 "Save Changes" Dialog

Three options are possible for the "Save changes" dialog: Yes & Exit (Save changes and exit to measuring mode), "Yes & ↑" (Save changes and go back one screen) and "No & Exit" (Don not save changes and exit to measuring mode). The "Yes & ↑" option is very useful if you want to continue configuring without having to re-enter the menu.

3.2.7 Security Passwords

The M400 transmitter allows a security lock-out of various menus. If the security lock-out feature of the transmitter has been enabled, a security password must be entered to allow access to the menu. See section 9.3 for more information.

3.2.8 Display

 **NOTE:** In the event of an alarm or other error condition the M400 Transmitter will display a flashing  a in the upper right corner of the display. This symbol will remain until the condition that caused it has been cleared.

 **NOTE:** During calibrations (Channel A), clean, Digital In with Analog Output/OC, a flashing "H" (Hold) will appear in the upper left corner of the display. During calibration on Channel B, a flashing "H" (Hold) will appear in the second line. Change to B and flash. This symbol will remain for 20 sec., after end of calibration. This symbol will remain for 20 seconds until after the calibration or clean is completed. This symbol will also disappear when Digital In is deactivated.

 **NOTE:** Channel A (A is shown on the left side of the display) indicates that a conventional sensor is connected to the transmitter.

Channel B (B is shown on the left side of the display) indicates, that an ISM Sensor is connected to the transmitter.

The M400 is a single input channel transmitter, and only one sensor can be connected at the same time.

4 Installation Instruction

4.1 Unpacking and Inspection of Equipment

Inspect the shipping container. If it is damaged, contact the shipper immediately for instructions. Do not discard the box.

If there is no apparent damage, unpack the container. Be sure all items shown on the packing list are present.

If items are missing, notify METTLER TOLEDO immediately.

4.1.1 Panel Cutout Dimensional Information – ½ DIN models

½ DIN Model transmitters are designed with an integral rear cover for stand-alone wall mount installation.

The unit may also be wall mounted using the integral rear cover. See installation instructions in Section 4.1.2.

Below are cut-out dimensions required by the ½ DIN models when mounted within a flat panel or on a flat enclosure door. This surface must be flat and smooth. Textured or rough surfaces are not recommended and may limit the effectiveness of the gasket seal provided.

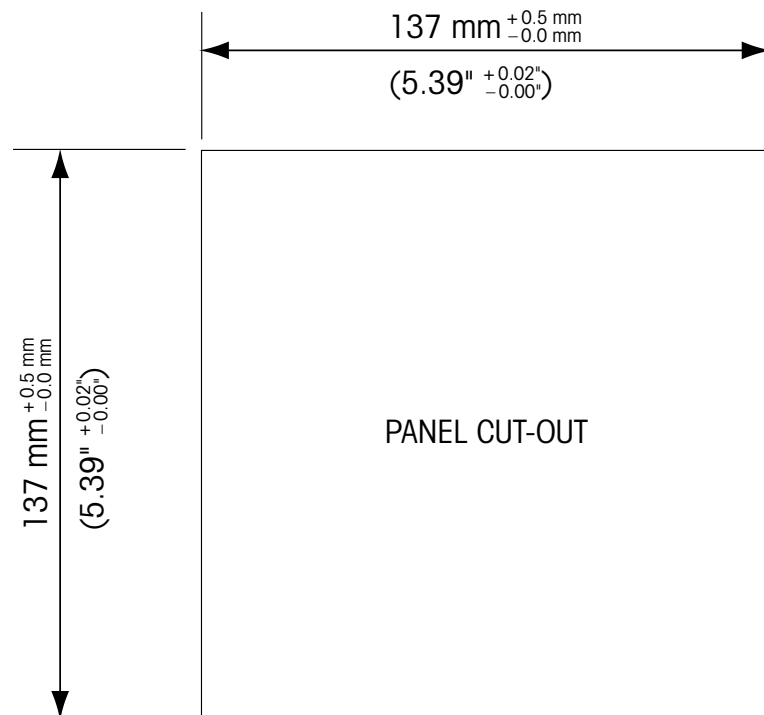

Optional hardware accessories are available that allow for panel- or pipe-mount. Refer to Section 15 for ordering information.

4.1.2 Installation Procedure

General:

- Orient the transmitter so that the cable grips face downward.
- Wiring routed through the cable grips shall be suitable for use in wet locations.
- In order provide IP66 enclosure ratings, all cable glands must be in place. Each cable gland must be filled using a cable, or suitable Cable Gland Hole Seal.

For Wall Mount:

- Remove rear cover from front housing.
- Start by unscrewing the four screws located on the face of the transmitter, in each corner. This allows the front cover to swing away from the rear housing.
- Remove the hinge-pin by squeezing the pin from each end. This allows the front housing to be removed from the rear housing.
- Mount rear housing to wall. Secure mounting kit to the M400 according to the supplied instructions. Attach to wall using appropriate mounting hardware for wall surface. Be sure it is level and securely fastened and the installation adheres to any and all clearance dimensions required for transmitter service and maintenance. Orient the transmitter so that the cable grips are facing downward.
- Replace the front housing to the rear housing. Securely tighten the rear-cover screws to ensure that IP66/NEMA4X enclosure environmental rating is maintained. The unit is ready to be wired.

For Pipe Mount:

- Use only manufacturer-supplied components for pipe-mounting the M400 transmitter and install per the supplied instructions. See section 15 for ordering information.

4.1.3 Assembly – ½ DIN Version

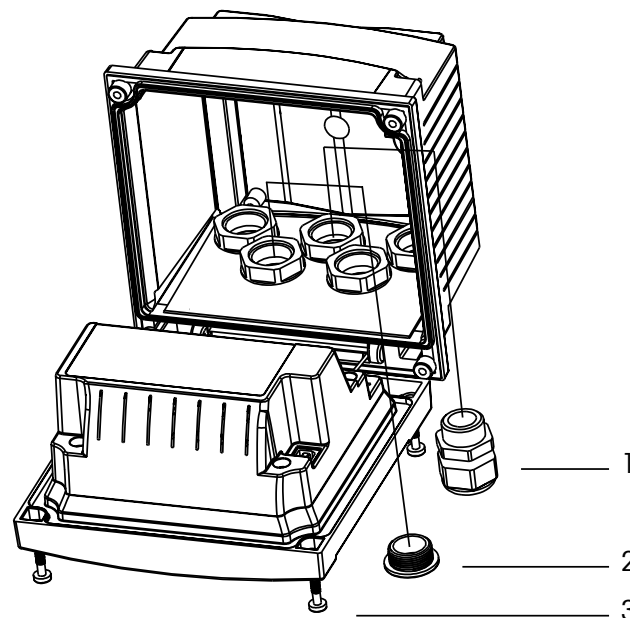

1. 3 M20X 1.5 cable glands
2. Plastics plugs
3. 4 screws

4.1.4 ½ DIN Version – Dimension Drawings

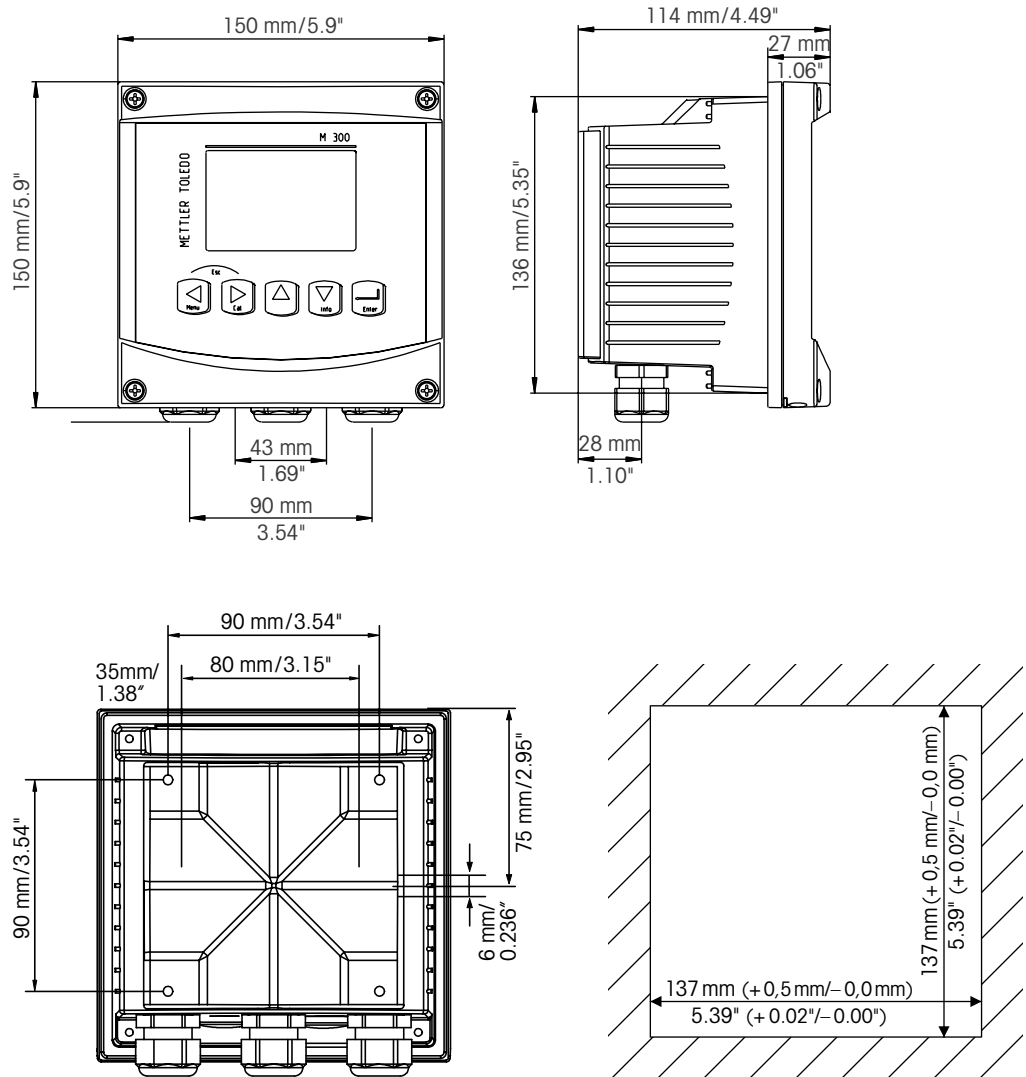

4.1.5 ½ DIN Version – Pipe Mounting

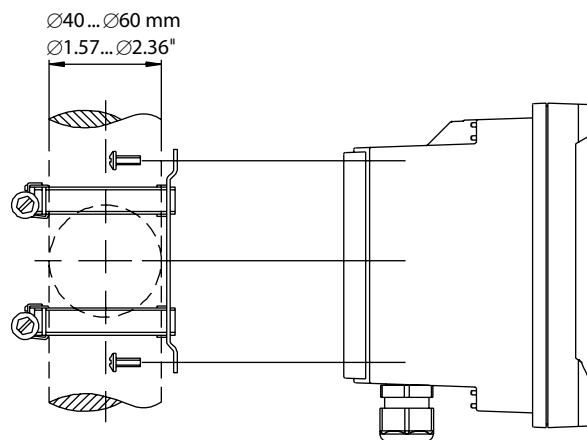

4.2 Connection of Power Supply

All connections to the transmitter are made on the rear panel of all models.



Be sure power to all wires is turned off before proceeding with the installation.

A two-terminal connector on the rear panel of all M400 models is provided for power connection. All M400 models are designed to operate from a 14–30 VDC power source. Refer to specifications for power requirements and ratings and size power wiring accordingly (AWG 16–24, wire cross-section 0.2 mm² to 1.5 mm²).

4.2.1 Housing (Wall Mount)

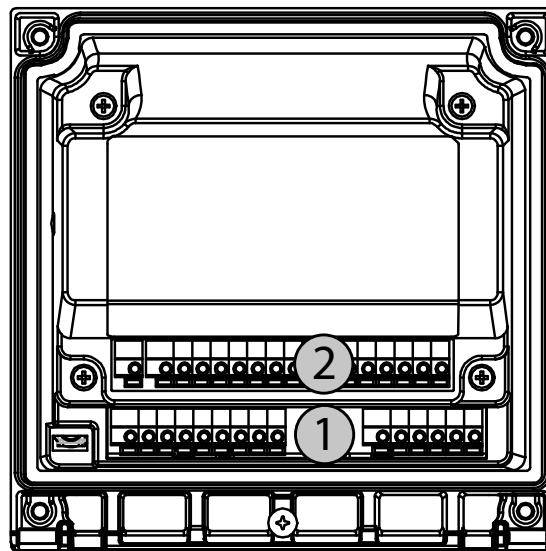

- 1: TB1 – Input and Output Analog Signal
- 2: TB2 – Sensor Signal

4.3 Terminal Block (TB) Definitions

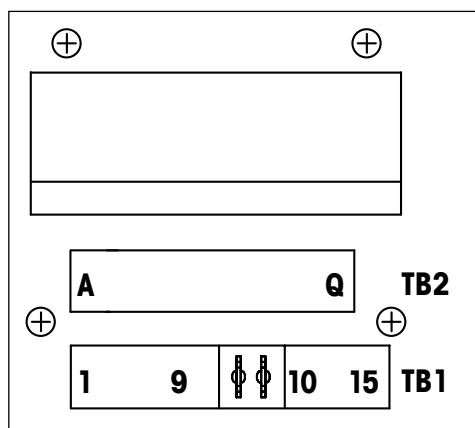

Power connections are labeled **A01+ /HART** and **A01- /HART** resp. **A02+** and **A02-** for 14 to 30 VDC.

4.4 Terminal Block TB1

Terminal	Designation	Description	
1	DI1+	Digital input 1	
2	DI1-		
3	DI2+		Digital input 2
4	DI2-		
5	Not used	-	
6	OC1+	Open collector output 1 (switch)	
7	OC1-		
8	OC2+	Open collector output 2 (switch)	
9	OC2-		
10	A01+ /HART	<ul style="list-style-type: none"> • Power connection 14 to 30 V DC • Analog output signal 1 • HART signal 	
11	A01- /HART		
12	A02+	<ul style="list-style-type: none"> • Power connection 14 to 30 V DC • Analog output signal 2 	
13	A02-		
14	Not used	-	
15	⏚	-	

4.5 Terminal Block TB2: Analog Sensors

4.5.1 Conductivity (2-e/4-e) Analog Sensors

Terminal	Function	Color
A	Cnd inner1 ¹⁾	White
B	Cnd outer1 ¹⁾	White/blue
C	Cnd outer1	–
D	Not used	–
E	Cnd outer2	–
F	Cnd inner2 ²⁾	Blue
G	Cnd outer2 (GND) ²⁾	Black
H	Not used	–
I	RTD ref/GND	Bare shield
J	RTD sense	Red
K	RTD	Green
L	Not used	–
M	Not used	–
N	Not used	–
O	Not used	–
P	Not used	–
Q	Not used	–

1) For third party Conductivity 2-e sensors a jumper between A and B may be required.

2) For third party Conductivity 2-e sensors a jumper between F and G may be required.

4.5.2 pH and Redox (ORP) Analog Sensors

Terminal	pH		Redox (ORP)	
	Function	Color ¹⁾	Function	Color
A	Glass	Transparent	Platinum	Transparent
B	Not used	–	–	–
C	Not used	–	–	–
D	Not used	–	–	–
E	Reference	Red	Reference	Red
F	Reference ²⁾	–	Reference ²⁾	–
G	Solution GND ²⁾	Blue ³⁾	Solution GND ²⁾	–
H	Not used	–	–	–
I	RTD ref/GND	White	–	–
J	RTD sense	–	–	–
K	RTD	Green	–	–
L	Not used	–	–	–
M	Shield (GND)	Green/yellow	Shield (GND)	Green/yellow
N	Not used	–	–	–
O	Not used	–	–	–
P	Not used	–	–	–
Q	Not used	–	–	–

1) Grey wire not used.

2) Install jumper between F and G for ORP sensors and pH electrodes without SG.

3) Blue wire for electrode with SG.

4.5.3 Amperometric Oxygen Analog Sensors

Terminal	Function	InPro 6800(G)	InPro 6900	InPro 6950
		Color	Color	Color
A	Not used	–	–	–
B	Anode	Red	Red	Red
C	Anode	– ¹⁾	– ¹⁾	–
D	Reference	– ¹⁾	– ¹⁾	Blue
E	Not used	–	–	–
F	Not used	–	–	–
G	Guard	–	Grey	Grey
H	Cathode	Transparent	Transparent	Transparent
I	NTC ref (GND)	White	White	White
J	Not used	–	–	–
K	NTC	Green	Green	Green
L	Not used	–	–	–
M	Shield (GND)	Green/yellow	Green/yellow	Green/yellow
N	Not used	–	–	–
O	Not used	–	–	–
P	+Ain ²⁾	–	–	–
Q	–Ain ²⁾	–	–	–

1) Install jumper between C and D for InPro 6800(G) and InPro 6900.

2) 4 to 20 mA signal for pressure compensation.

4.6 Terminal Block TB2: ISM Sensors

4.6.1 pH, Amperometric Oxygen, Conductivity (4-e) and Dissolved Carbon Dioxide ISM Sensors

Terminal	Function	Color
A	Not used	–
B	Not used	–
C	Not used	–
D	Not used	–
E	Not used	–
F	Not used	–
G	Not used	–
H	Not used	–
I	Not used	–
J	Not used	–
K	Not used	–
L	1-wire	Transparent (cable core)
M	GND	Red (shield)
N	RS485-B	–
O	RS485-A	–
P	+Ain ¹⁾	–
Q	–Ain ¹⁾	–

1) Only for Oxygen sensors: 4 to 20 mA signal for pressure compensation.

4.6.2 Optical Oxygen ISM Sensors

Terminal	Optical Oxygen with VP8 Cable ¹⁾		Optical Oxygen with other Cables ²⁾	
	Function	Color	Function	Color
A	Not used	–	Not used	–
B	Not used	–	Not used	–
C	Not used	–	Not used	–
D	Not used	–	Not used	–
E	Not used	–	Not used	–
F	Not used	–	Not used	–
G	Not used	–	Not used	–
H	Not used	–	Not used	–
I	Not used	–	D_GND (shield)	Yellow
J	Not used	–	Not used	–
K	Not used	–	Not used	–
L	Not used	–	Not used	–
M	D_GND (shield)	Green/yellow	D_GND (shield)	Grey
N	RS485-B	Brown	RS485-B	Blue
O	RS485-A	Pink	RS485-A	White
P	+Ain ³⁾	–	+Ain ³⁾	–
Q	–Ain ³⁾	–	–Ain ³⁾	–

1) Connect the grey +24 DC wire and the blue GND_24 V wire of the sensor separately to an external power supply.

2) Connect the brown +24 DC wire and the black GND_24 V wire of the sensor separately.

3) 4 to 20 mA signal for pressure compensation.

4.7 Connection of ISM Sensors

4.7.1 Connection of ISM Sensors for pH/ORP, Conductivity 4-e and Amperometric Oxygen Measurement

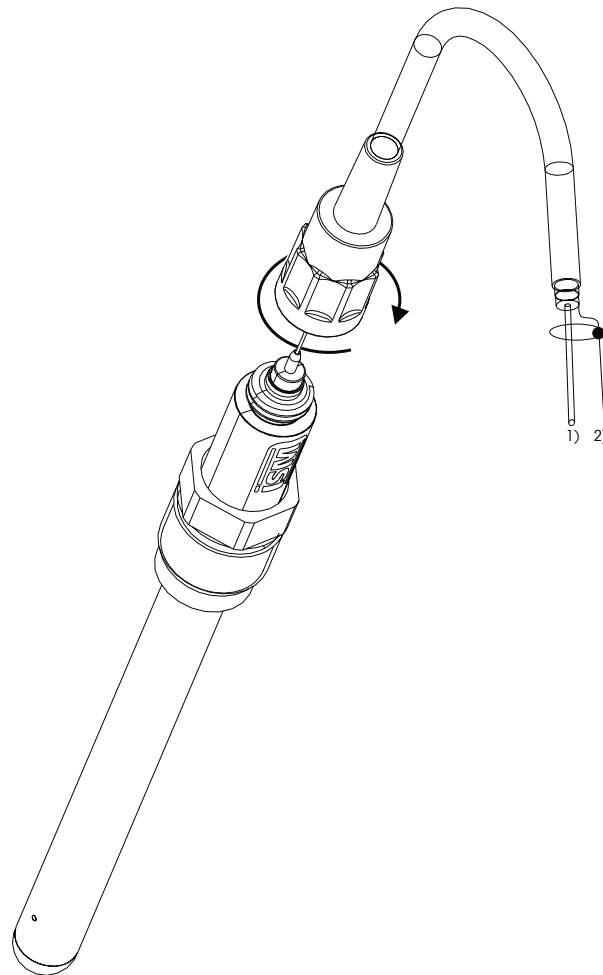

NOTE: Connect the sensor and screw the plug head clockwise (hand tight).

4.7.2 TB2 – AK9 Cable Assignment

- 1) 1-wire data (transparent)
- 2) Ground/shield

4.8 Connection of Analog Sensors

4.8.1 Connection of Analog Sensor for pH/ORP

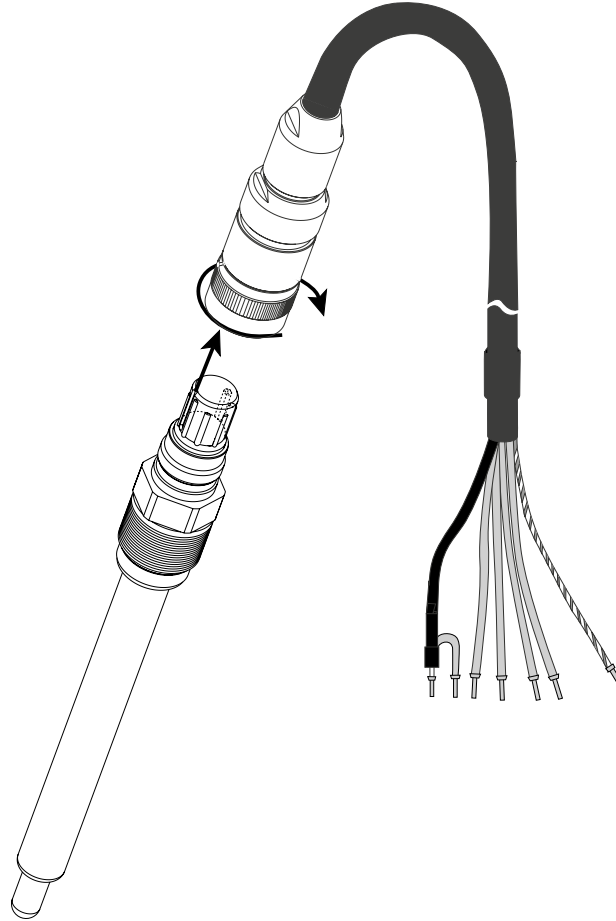

 **NOTE:** Cable lengths > 20 m can worsen the response during pH measurement. Be sure to observe the sensor instruction manual.

4.8.2 TB2 – Typical Wiring for Analog pH/ORP Sensor

4.8.2.1 Example 1

pH measurement without Solution Ground

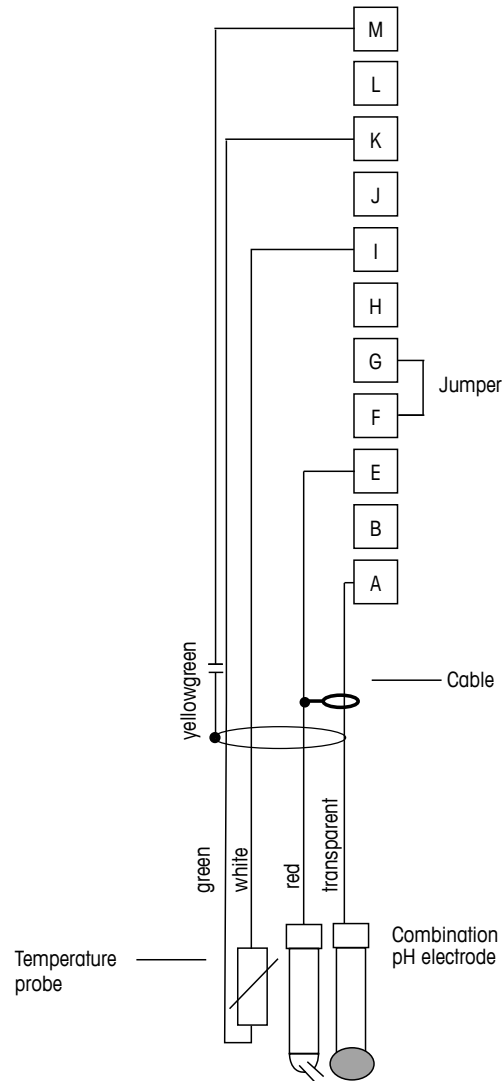

 **NOTE:** Jumper terminals G and F

Wire Colors only valid for connection with VP cable; blue and grey not connected.

- A: Glass
- E: Reference
- I: RTD ref/GND
- K: RTD
- M: Shield/GND

4.8.2.2 Example 2

pH measurement with Solution Ground

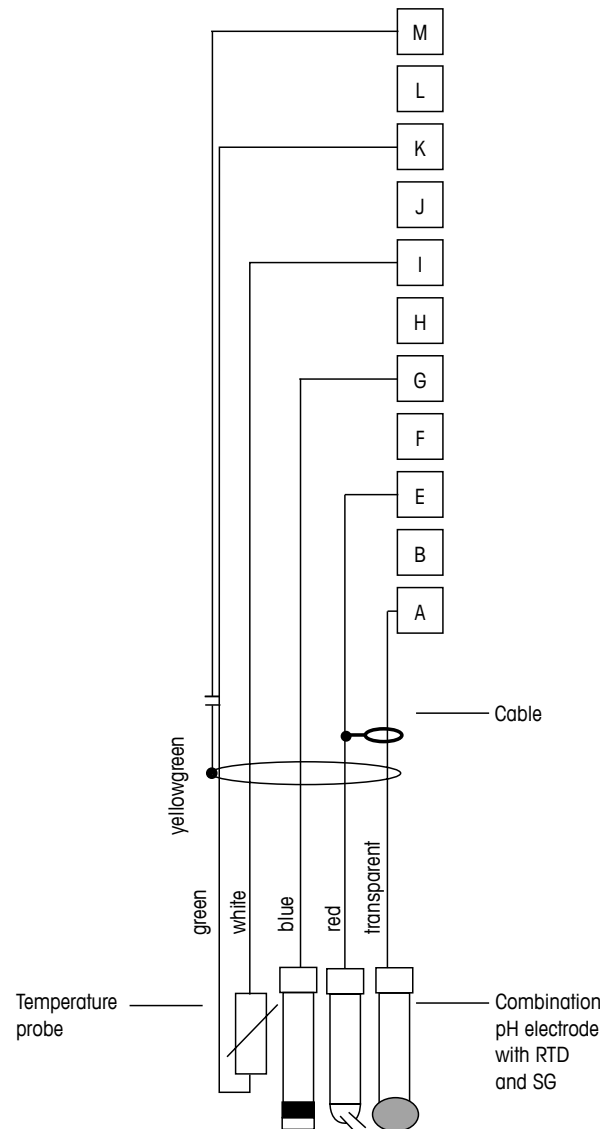

 **NOTE:** Wire colors only valid for connection with VP cable, grey not connected.

A: Glass
 E: Reference
 G: Shield/Solution GND
 I: GND/RTD ret
 K: RTD
 M: Shield(GND)

4.8.2.3 Example 3

ORP (redox) measurement (temperature optional)

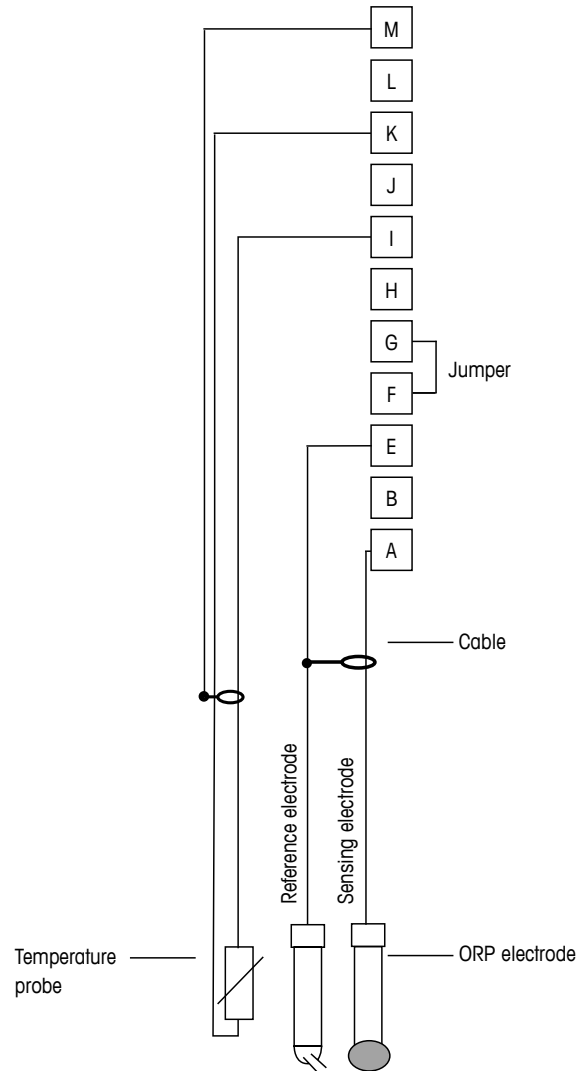

 **NOTE:** Jumper terminal G and F

- A: Platinum
- E: Reference
- I: RTD ref/GND
- K: RTD
- M: Shield(GND)

4.8.2.4 Example 4

ORP measurement with pH solution ground electrode (e.g. InPro 3250, InPro 4800 SG).

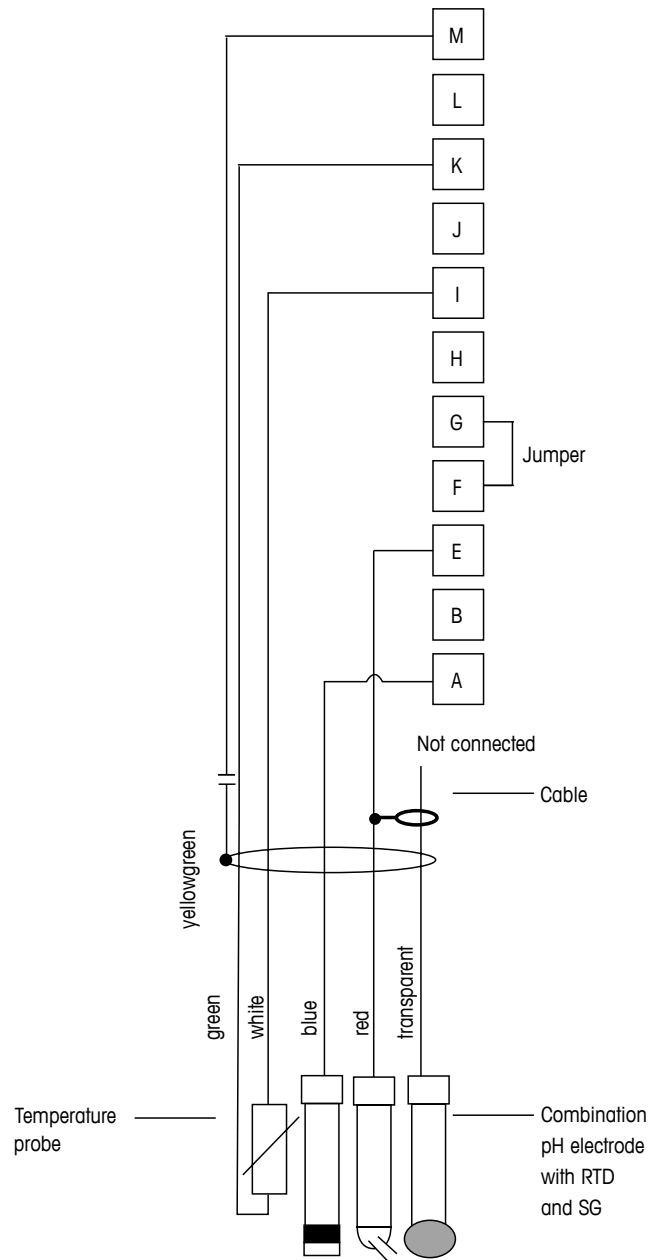

NOTE: Jumper terminal G and F

A: Platinum
 E: Reference
 I: RTD ref/GND
 K: RTD
 M: Shield(GND)

4.8.3 Connection of Analog Sensor for Amperometric Oxygen Measurement

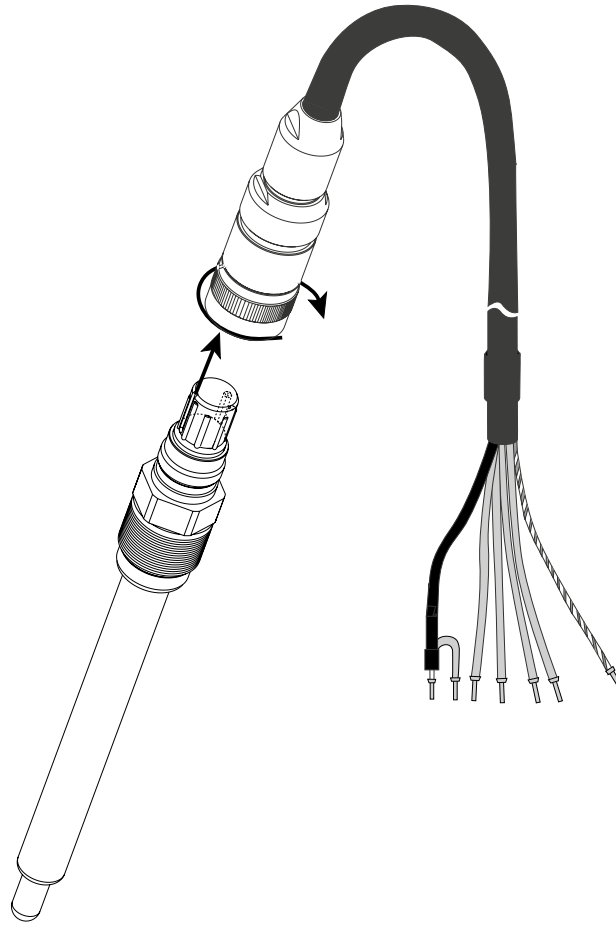

 **NOTE:** Be sure to observe the sensor instruction manual.

4.8.4 TB2 – Typical Wiring for Analog Sensor for Amperometric Oxygen Measurement

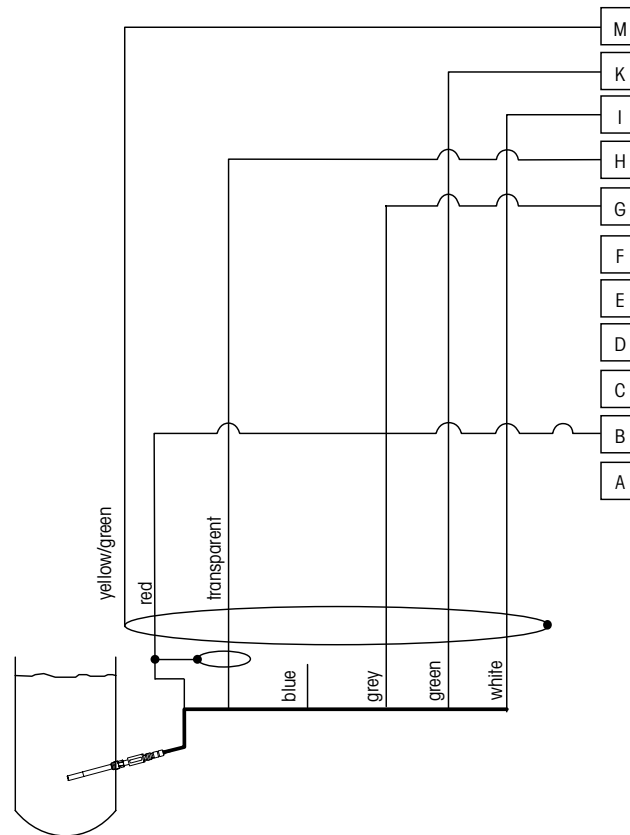

NOTE: Wire colors only valid for connection with VP cable, but not connected.

M400 connector:

B: Anode

G: Reference

H: Cathode

I: NTC ref/Guard

K: NTC

M: Shield (GND)

5 Placing Transmitter in, or Out of Service

5.1 Placing Transmitter in Service



After connecting the transmitter to power supply circuit, it will be active as soon as the circuit is powered.

5.2 Placing Transmitter Out of Service



First disconnect the unit from the main power source, then disconnect all remaining electrical connections. Remove the unit from the wall/panel. Use the installation instruction in this manual as reference for dis-assembling mounting hardware.

All transmitter settings stored in memory are non volatile.

6 Quick Setup

(PATH: Menu/Quick Setup)

Select Quick Setup and press the [ENTER] key. Enter the security code if necessary (see section 9.2 "Passwords")

-  **NOTE:** Please find the complete description of the Quick Setup routine described in the separate booklet "Quick Setup Guide for Transmitter M400" enclosed in the box.
-  **NOTE:** Please do not use Quick Setup menu after configuration of the transmitter, because some of the parameters i.e. analog output configuration will may be reseted.
-  **NOTE:** Refer to section 3.2 "Control/Navigation Keys" for information on menu navigation.

7 Sensor Calibration

(PATH: Cal)

The calibration key ► allows the user one-touch access to sensor calibration and verification features.



NOTE: During Calibration on Channel A, a flashing "H" (Hold) in the upper left corner of the Display indicates a calibration is in process with a Hold condition active. (The hold output needs to be activated.) See also chapter 3.2.8 "Display".

7.1 Enter Calibration Mode

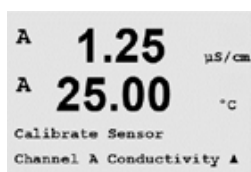

While in Measurement mode press the ► key. If the display prompts you to enter the Calibration security code, press the ▲ or ▼ key to set the calibration security mode, the [ENTER] key to confirm the calibration security code.

Press the ▲ or ▼ key to select the type of calibration desired.

7.1.1 Select the Desired Sensor Calibration Task

For analog sensors depending on sensor type, the following choices are available:

Analog sensor	Calibration task
Conductivity	Conductivity, Resistivity, Temperature, Edit, Verify
Amp. Oxygen	Oxygen, Temperature, Edit, Verify
pH	pH, mV, Temperature, Edit pH, Edit mV, Verify

For ISM (digital) sensors depending on sensor type, the following choices are available:

ISM sensor	Calibration task
Conductivity	Conductivity, Resistivity, Verify
Amp. Oxygen	Oxygen, Verify
pH	pH, ORP, Verify
Optical Oxygen	O ₂ , Verify
CO ₂	CO ₂ , Verify

7.1.2 Finish Calibration

After every successful calibration the following options are available.

After selection the message "RE-INSTALL SENSOR and Press [ENTER]" appears on the display. Press [ENTER] to return to the measuring mode.

Analog sensors

Adjust: Calibration values are stored in the transmitter and used for the measurement. Additionally, the calibration values are stored in the calibration data.

Calibrate: The function "Calibrate" is not applicable for analog sensors.

Abort: Calibration values are discarded.

ISM (digital) sensors

Adjust: Calibration values are stored in the sensor and used for the measurement. Additionally, the calibration values are stored in the calibration history.

Calibrate: Calibration values are stored in the calibration history for documentation, but not be used for the measurement. The calibration values from the last valid adjustment are further used for the measurement.

Abort: Calibration values are discarded.

7.2 Conductivity Calibration for Two- or Four-Electrode Sensors

This feature provides the ability to perform a one-point, two-point or process Conductivity resp. Resistivity "Sensor" calibration for two- or four-electrode sensors. The procedure described below works for both types of calibrations. There is no reason to perform a two-point calibration on a two-electrode conductivity sensor.



NOTE: When performing calibration on a conductivity sensor, results will vary depending on the methods, calibration apparatus and/or quality of reference standards used to perform the calibration.



NOTE: For measuring tasks the temperature compensation for the application as defined at the menu Resistivity will be considered and not the temperature compensation selected thru the calibration procedure (see also chapter 8.2.3.1 "Conductivity Temperature Compensation"; PATH: Menu/Configure/Measurement/Resistivity).

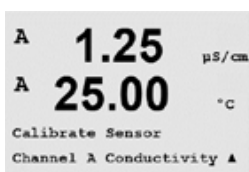

Enter Conductivity sensor calibration mode as described in section 7.1 "Enter Calibration Mode".

The next screen will ask to select the type of temperature compensation mode desired during the calibration process.



Choices are "Standard", "Lin 25 °C", "Lin 20 °C" or "Nat H₂O" compensation mode.

Standard compensation: includes compensation for non-linear high purity effects as well as conventional neutral salt impurities and conforms to ASTM standards D1125 and D5391.

Lin 25 °C compensation: adjusts the reading by a factor expressed as "% per °C" deviation from 25 °C. The factor can be modified.

Lin 20 °C compensation: adjusts the reading by a factor expressed as "% per °C" deviation from 20 °C. The factor can be modified.

Nat H₂O compensation: includes compensation to 25 °C according to EN27888 for natural water.

Choose the compensation mode, modify the factor where appropriate and press [ENTER].

7.2.1 One-Point Sensor Calibration

(Display reflects typical Conductivity Sensor calibration)

Enter Conductivity Sensor Calibration mode as described in section 7.1 "Enter Calibration Mode" and choose one of the compensation modes (see section 7.2 "Conductivity Calibration for Two- or Four-Electrode Sensors").

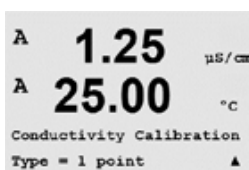

Select 1 point calibration and press [ENTER]. With conductivity sensors a one-point calibration is always performed as a slope calibration.

Place the electrode into the reference solution.

```

A 1.25 µS/cm
A 25.00 °C
A Point1 = 1.413 µS/cm
A C = 1.250 µS/cm ▲

```

Enter the value for Point 1 including a decimal point and units. The value in the second text line is the value being measured by the transmitter and sensor in the units selected by the user. Press [ENTER] when this value is stable to perform the calibration.

```

A 1.25 µS/cm
A 25.0 °C
C M=0.09712 A=0.00000
Save Adjust ↑

```

After the calibration the cell multiplier or slope calibration factor "M" i.e. cell constant and the Adder or offset calibration factor "A" are displayed.

For ISM (digital) sensors select ADJUST, CALIBRATE or ABORT to finish calibration. For Analog sensors select ADJUST or ABORT to finish calibration. See „7.1.2 Finish Calibration“.

7.2.2 Two-Point Sensor Calibration (Four Electrode Sensors Only)

(Display reflects typical Conductivity sensor calibration)

Enter Conductivity Sensor Calibration mode as described in section 7.1 "Enter Calibration Mode" and choose one of the compensation modes (see section 7.2 "Conductivity Calibration for Two- or Four-Electrode Sensors").

```

A 1.25 µS/cm
A 25.00 °C
Conductivity Calibration
Type = 2 point ▲

```

Select 2 point calibration and press [ENTER].

Place the electrode into the first reference solution.



CAUTION: Rinse sensors with a high-purity water solution between calibration points to prevent contamination of the reference solutions.

```

A 1.25 µS/cm
A 25.00 °C
A Point2 = 0.055 µS/cm
A C = 0.057 µS/cm ▲

```

Enter the value for Point 1 including a decimal point and units. The value in the second text line is the value being measured by the transmitter and sensor in the units selected by the user. Press [ENTER] when this value is stable and place the electrode into the second reference solution.

Enter the value for Point 2 including a decimal point and units. The value in the second text line is the value being measured by the transmitter and sensor in the units selected by the user. Press [ENTER] when this value is stable to perform the calibration.

```

A 1.25 µS/cm
A 25.0 °C
C M=0.09712 A=0.00000
Save Adjust ↑

```

After the calibration of the cell multiplier or slope calibration factor "M" i.e. cell constant and the adder or offset calibration factor "A" are displayed.

For ISM (digital) sensors select ADJUST, CALIBRATE or ABORT to finish calibration. For Analog sensors select ADJUST or ABORT to finish calibration. See „7.1.2 Finish Calibration“.

7.2.3 Process Calibration

(Display reflects typical Conductivity sensor calibration)

Enter Conductivity Sensor Calibration mode as described in section 7.1 "Enter Calibration Mode" and choose one of the compensation modes (see section 7.2 "Conductivity Calibration for Two- or Four-Electrode Sensors").



Select Process Calibration and press [ENTER]. With conductivity sensors a process calibration is always performed as a slope calibration.

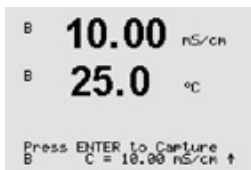

Take a sample and press the [ENTER] key again to store the current measuring value.

During the ongoing calibration process, the letter of the channel, which is concerned by the calibration, "A" or "B" is blinking in the display.

After determining the conductivity value of the sample, press the [CAL] key again to proceed with the calibration.

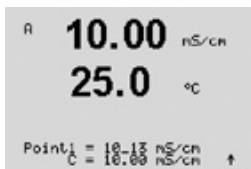

Enter the conductivity value of the sample, then press the [ENTER] key to start the calculation of calibration results.

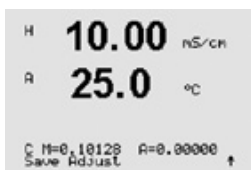

After the calibration the Multiplier or slope calibration factor "M" and the Adder or offset calibration factor "A" are displayed.

For ISM (digital) sensors select ADJUST, CALIBRATE or ABORT to finish calibration. For Analog sensors select ADJUST or ABORT to finish calibration. See „7.1.2 Finish Calibration“.

7.3 Calibration of Amperometric Oxygen Sensors

Oxygen calibration for amperometric sensors is performed as either a one-point or process calibration.



NOTE: Before air calibration, for highest accuracy, enter the barometric pressure and relative humidity, as described in section 8.2.3.4 "Parameters for Oxygen Measurement Based on Amperometric Sensors".

7.3.1 One-Point Calibration for Amperometric Oxygen Sensors

```

B  98.6  %sat
B  25.0  °C
Calibrate Sensor
Channel B Oxygen ↑
  
```

Enter Oxygen calibration mode as described in section 7.1 "Enter Calibration Mode".

A one-point calibration of oxygen sensors is always either a one point slope (i.e. with air) or a zero (offset) calibration. A one point slope calibration is done in air and a one point offset calibration is done at 0 ppb oxygen. A one-point zero dissolved oxygen calibration is available but not normally recommended since zero oxygen is very hard to achieve. A zero-point calibration is only recommended if high accuracy at low oxygen level (below 5% air) is needed.

```

B  98.6  %sat
H  25.0  °C
O2 Calibration
Type = 1 point Slope ↑
  
```

Select 1 point followed by either Slope or ZeroPt as the calibration type. Press [ENTER].

```

B  98.6  %air
B  25.0  °C
CalPres = 759.8 mHg
RelativeHumid = 100 % ↑
  
```

Adjust calibration pressure (CalPres) and relative humidity (RelativeHumid), which are applied during calibration. Press [ENTER].

```

B  98.6  %air
B  25.0  °C
Press ENTER when
Sensor is in Gas 1(Air) ↑
  
```

Place the sensor in the calibration gas (e.g. air) resp. solution. Press [ENTER].

Depending on the parameterized Drift control (see chapter 8.2.3.4 "Parameters for Oxygen Measurement Based on Amperometric Sensors") one of the two following modes is active.

7.3.1.1 Auto Mode



NOTE: For a zero point calibration the Auto mode is not available. If Auto mode has been configured (see section 8.2.3.4 "Parameters for Oxygen Measurement Based on Amperometric Sensors") and an offset calibration will be executed, the transmitter will perform the calibration in Manual mode.

```

B  98.6  %sat
B  25.0  °C
B Point1 = 100.5 %sat
B O2 = 98.6 %sat ↑
  
```

Enter the value for Point 1 including a decimal point and units. The value in the second text line is the value being measured by the transmitter and sensor in the units selected by the user.

```

B  98.6  %sat
B  25.0  °C
O2 S=-69.66nA Z=0.0000nA
Save Adjust ↑
  
```

As soon as the stabilization criteria have been fulfilled the display changes. The display shows the calibration result for slope "S" and offset value "Z".

For ISM (digital) sensors select ADJUST, CALIBRATE or ABORT to finish calibration. For Analog sensors select ADJUST or ABORT to finish calibration. See „7.1.2 Finish Calibration“.

7.3.1.2 Manual Mode

```
B 98.6 %sat
B 25.0 °C
B Point1 = 100.5 %sat
B O2 = 98.6 %sat ↑
```

Enter the value for Point 1 including a decimal point and units. The value in the second text line is the value being measured by the transmitter and sensor in the units selected by the user. Press [ENTER] when this value is stable to perform the calibration.

```
B 98.6 %sat
B 25.0 °C
O2 S=-69.66mA Z=0.0000nA
Save Adjust ↑
```

After the calibration the slope "S" and the offset value "Z" are displayed.

For ISM (digital) sensors select ADJUST, CALIBRATE or ABORT to finish calibration. For Analog sensors select ADJUST or ABORT to finish calibration. See „7.1.2 Finish Calibration“.



NOTE: With ISM sensors: If a one point calibration is executed, the transmitter sends the polarization voltage, valid for the calibration, to the sensor. If the polarization voltage for the measuring mode and calibration mode is different, the transmitter will wait 120 seconds before starting the calibration. In this case the transmitter will also go after the calibration for 120 seconds to the HOLD Mode, before returning to the measuring mode again. (see also chapter 8.2.3.4 "Parameters for Oxygen Measurement Based on Amperometric Sensors").

7.3.2 Process Calibration for Amperometric Oxygen Sensors

```
B 57.1 %sat
B 25.0 °C
Calibrate Sensor
Channel B Oxygen ↑
```

Enter Oxygen calibration mode as described in section 7.1 "Enter Calibration Mode".

A process calibration of oxygen sensors is always either a slope or a offset calibration.

```
B 57.1 %sat
B 25.0 °C
O2 Calibration
Type = Process Slope ↑
```

Select Process followed by either Slope or ZeroPt as the calibration type. Press [ENTER]

```
B 57.1 %air
B 25.0 °C
Press ENTER to Capture
B O2=57.1 %air ↑
```

Take a sample and press the [ENTER] key again to store the current measuring value. To show the ongoing calibration process, A or B (depending on the channel) is blinking in the display.

After determining the O₂ value of the sample press the ► key again to proceed with the calibration.

```
B 57.1 %sat
B 25.0 °C
B Point1 = 56.90 %sat
B O2 = 57.1 %sat ↑
```

Enter the O₂ value of the sample then press the [ENTER] key to start the calculation of the calibration results.

```
57.1 %sat
25.0 °C
O2 S=-0.076nA Z=0.0000nA
Save Adjust ↑
```

After the calibration the slope "S" and the offset value "Z" are displayed.

For ISM (digital) sensors select ADJUST, CALIBRATE or ABORT to finish calibration. For Analog sensors select ADJUST or ABORT to finish calibration. See „7.1.2 Finish Calibration“.

7.4 Calibration of Optical Oxygen Sensors (Only for ISM Sensors)

Oxygen calibration for optical sensors can be performed as a two-point, process or, depending on the sensor model connected to the transmitter, also as a one-point calibration.

7.4.1 One-Point Calibration for Optical Oxygen Sensors

Typically a one-point calibration is done in air. Nevertheless other calibration gases and solutions are possible.

The calibration of an optical sensor is always a calibration of the phase of the fluorescence signal towards the internal reference. During a one-point calibration the phase in this point is measured and extrapolated over the measuring range.

Enter O₂ opt calibration mode as described in section 7.1 "Enter Calibration Mode".

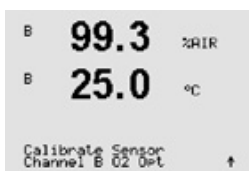

Select 1 point as the calibration type. Press [ENTER].

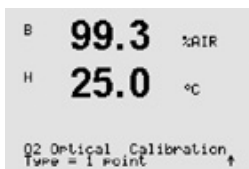

Place the sensor in the calibration gas (e.g. air) resp. solution.

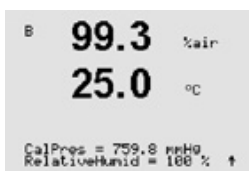

Adjust calibration pressure (CalPres) and relative humidity (RelativeHumid), which are applied during calibration. Press [ENTER].

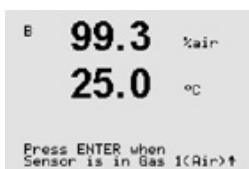

Place the sensor in the calibration gas (e.g. air) resp. solution. Press [ENTER].

Depending on the parameterized Drift control (see section 8.2.3.5 "Parameters for Oxygen Measurement Based on Optical Sensors") one of the two following modes is active.

7.4.1.1 Auto Mode

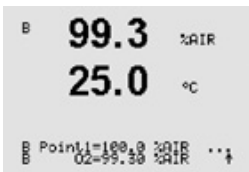

Enter the value for Point 1 including a decimal point and units. The value in the second text line is the value being measured by the transmitter resp. sensor in the units selected by the user.

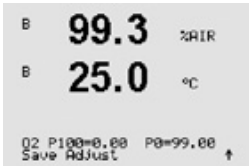

As soon as the stabilization criteria have been fulfilled the display changes. The display shows now the values for the phase of the sensor at 100 % air (P100) and at 0 % (P0) air.

Select ADJUST, CALIBRATE or ABORT to finish calibration. See „7.1.2 Finish Calibration“.

7.4.1.2 Manual Mode

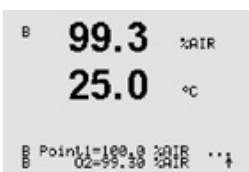

Enter the value for Point 1 including a decimal point and units. The value in the second text line is the value being measured by the transmitter resp. sensor in the units selected by the user.

Press [ENTER] to proceed.

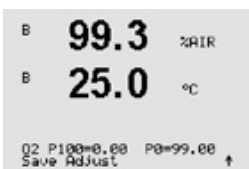

The display shows now the values for the phase of the sensor at 100 % air (P100) and at 0 % (P0) air.

Select ADJUST, CALIBRATE or ABORT to finish calibration. See „7.1.2 Finish Calibration“.

7.4.2 Two-Point Sensor Calibration

The calibration of an optical sensor is always a calibration of the phase of the fluorescence signal towards the internal reference. A two-point calibration is a combination of first a calibration in air (100 %) where a new phase P100 is measured and then a calibration in nitrogen (0 %) where a new phase P0 is measured. This calibration routine gives the most accurate calibration curve over the whole measuring range.

Enter O₂ opt calibration mode as described in section 7.1 “Enter Calibration Mode“.

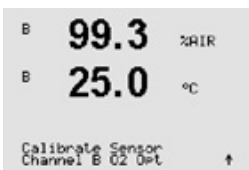

Select 2 point as the calibration type. Press [ENTER].

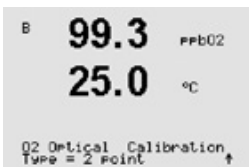

Adjust calibration pressure (CalPres) and relative humidity (RelativeHumid), which are applied during calibration. Press [ENTER].

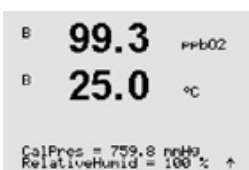

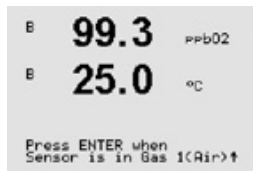

Place the sensor in the first calibration gas (e.g. air) resp. solution. Press [ENTER].

Depending on the parameterized Drift control (see section 8.2.3.5 "Parameters for Oxygen Measurement Based on Optical Sensors") one of the two following modes is active.

7.4.2.1 Auto Mode

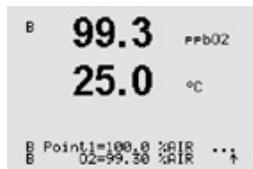

Enter the value for Point 1 including a decimal point and units. The value in the second text line is the value being measured by the transmitter resp. sensor in the units selected by the user.

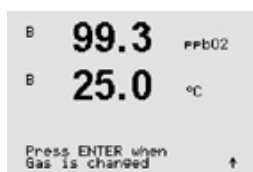

As soon as the stabilisation criteria have been fulfilled, the display changes and prompts you to change the gas.

Place the sensor in the second calibration gas and press the [ENTER] key to go on with the calibration.

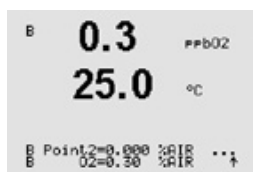

Enter the value for Point 2 including a decimal point and units. The value in the second text line is the value being measured by the transmitter resp. sensor.

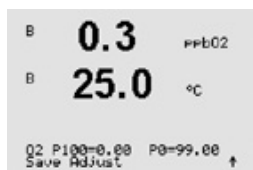

As soon as the stabilization criteria have been fulfilled the display changes. The display shows now the values for the phase of the sensor at 100% air (P100) and at 0% (P0) air.

Select ADJUST, CALIBRATE or ABORT to finish calibration. See „7.1.2 Finish Calibration“.

7.4.2.2 Manual Mode

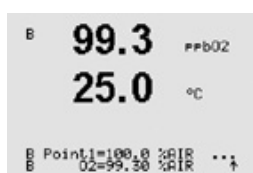

Enter the value for Point 1 including a decimal point and units. The value in the second text line is the value being measured by the transmitter resp. sensor in the units selected by the user.

Press [ENTER] to proceed.

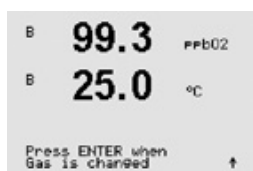

The display changes and prompts you to change the gas.

Place the sensor in the second calibration gas and press the [ENTER] key to go on with the calibration.

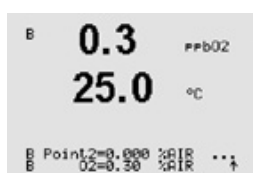

Enter the value for Point 2 including a decimal point and units. The value in the second text line is the value being measured by the transmitter resp. sensor.

Press [ENTER] to proceed.

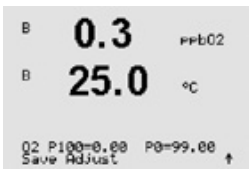

The display shows now the values for the phase of the sensor at 100 % air (P100) and at 0 % (P0) air.

Select ADJUST, CALIBRATE or ABORT to finish calibration. See „7.1.2 Finish Calibration“.

7.4.3 Process Calibration

The calibration of an optical sensor is always a calibration of the phase of the fluorescence signal towards the internal reference. During a process calibration the phase in this point is measured and extrapolated over the measuring range. For InPro 6860i sensors “Scaling” is the default setting.

Enter O₂ opt calibration mode as described in section 7.1 “Enter Calibration Mode”.

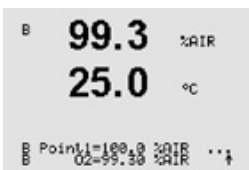

Select 1 point as the calibration type. Press [ENTER].

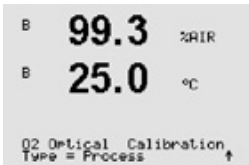

Take a sample and press the [ENTER] key again to store the current measuring value. To show the ongoing calibration process, A or B (depending on the channel) is blinking in the display.

After determining the O₂ value of the sample press the [CAL] key again to proceed with the calibration.

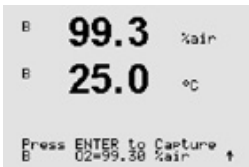

Enter the O₂ value of the sample then press the [ENTER] key to start calibration.



The display shows now the values for the phase of the sensor at 100 % air (P100) and at 0 % (P0) air.

Select ADJUST, CALIBRATE or ABORT to finish calibration. See „7.1.2 Finish Calibration“.

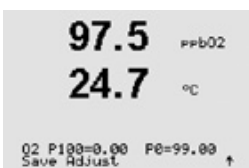

7.5 pH Calibration

For pH sensors, the M400 transmitter features one-point, two-point (Auto or Manual mode) or process calibration with 9 preset buffer sets or manual buffer entry. Buffer values refer to 25 °C. To calibrate the instrument with automatic buffer recognition, you need a standard pH buffer solution that matches one of these values. (See section 8.2.3.3 "pH/ORP parameters" for configuring modes and selecting buffer sets.) Please select the correct buffer table before using automatic calibration (see chapter 19 "Buffer Tables").



NOTE: For dual membrane pH electrodes (pH/pNa) only buffer Na+ 3.9M (see section 19.2.1 "Mettler-pH/pNa buffers") is available.

7.5.1 One Point Calibration



Enter pH calibration mode as described in section 7.1 "Enter Calibration Mode".

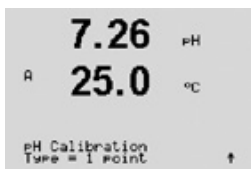

Select 1 point Calibration. With pH sensors a one point calibration is always performed as a offset calibration.

Depending on the parameterized Drift control (see chapter 8.2.3.3 "pH/ORP Parameters") one of the two following modes is active.

7.5.1.1 Auto Mode

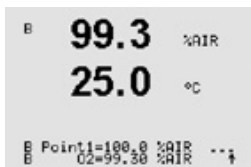

Place the electrode in the buffer solution and press the [ENTER] key to start the calibration.

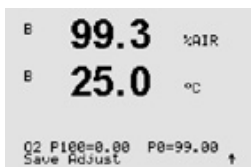

The display shows the buffer the transmitter has recognized (Point 1) and the measured value.

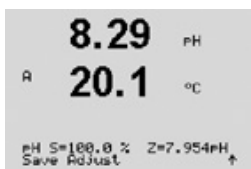

As soon as the stabilisation criteria have been fulfilled the display changes. The display shows now the slope calibration factor S and the offset calibration factor Z.

For ISM (digital) sensors select ADJUST, CALIBRATE or ABORT to finish calibration. For Analog sensors select ADJUST or ABORT to finish calibration. See „7.1.2 Finish Calibration“.

7.5.1.2 Manual Mode

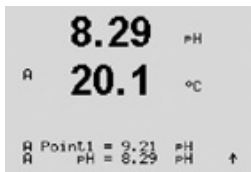

Place the electrode in the buffer solution. The display shows the buffer the transmitter has recognized (Point 1) and the measured value. Press [ENTER] to proceed.



The display shows now the slope calibration factor S and the offset calibration factor Z.

For ISM (digital) sensors select ADJUST, CALIBRATE or ABORT to finish calibration. For Analog sensors select ADJUST or ABORT to finish calibration. See „7.1.2 Finish Calibration“.

7.5.2 Two-Point Calibration



Enter pH calibration mode as described in section 7.1 “Enter Calibration Mode“.

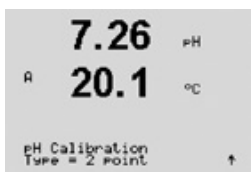

Select 2 Point calibration.

Depending on the parameterized Drift control (see chapter 8.2.3.3 “pH/ORP Parameters“) one of the two following modes is active.

7.5.2.1 Auto Mode

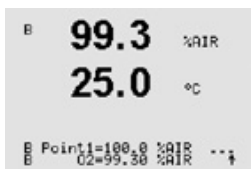

Place the electrode in the first buffer solution and then press the [ENTER] key.

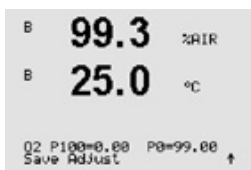

The display shows the buffer the transmitter has recognized (Point 1) and the measured value.

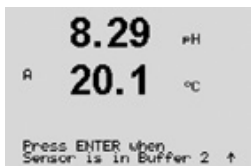

As soon as the stabilisation criteria have been fulfilled stabilisation criteria have been fulfilled, the display changes and prompts you to place the electrode in the second buffer.

Place the electrode in the second buffer solution and press the [ENTER] key to go on with the calibration.

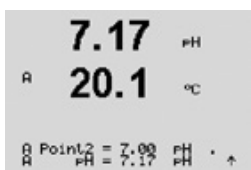

The display shows the second buffer the transmitter has recognized (Point 2) and the measured value.



As soon as the stabilisation criteria have been fulfilled the display changes to show the slope calibration factor S and the offset calibration factor Z.

For ISM (digital) sensors select ADJUST, CALIBRATE or ABORT to finish calibration. For Analog sensors select ADJUST or ABORT to finish calibration. See „7.1.2 Finish Calibration“.

7.5.2.2 Manual Mode

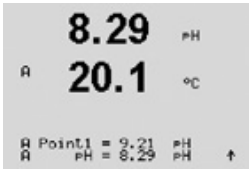

Place the electrode in the first buffer solution. The display shows the buffer the transmitter has recognized (Point 1) and the measured value. Press [ENTER] to proceed.



Place the transmitter in the second buffer solution. The display shows the buffer the transmitter has recognized (Point 2) and the measured value. Press [ENTER] to proceed.



The display shows the slope calibration factor S and the offset calibration factor Z.

For ISM (digital) sensors select ADJUST, CALIBRATE or ABORT to finish calibration. For Analog sensors select ADJUST or ABORT to finish calibration. See „7.1.2 Finish Calibration“.

7.5.3 Process Calibration



Enter pH calibration mode as described in section 7.1 “Enter Calibration Mode”.

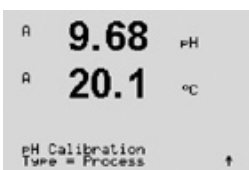

Select Process calibration. With pH sensors a process calibration is always performed as a offset calibration.

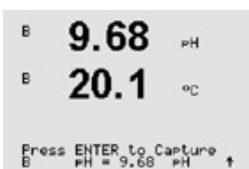

Take a sample and press the [ENTER] key again to store the current measuring Value. To show the ongoing calibration process, A or B (depending on the channel) is blinking in the display.



After determining the pH value of the sample, press the [CAL] key again to proceed with the calibration.

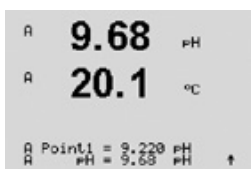

Enter the pH value of the sample then press the [ENTER] key to start the calculation of the calibration results.



After the calibration the slope calibration factor S and the offset calibration factor Z are displayed.

For ISM (digital) sensors select ADJUST, CALIBRATE or ABORT to finish calibration. For Analog sensors select ADJUST or ABORT to finish calibration. See „7.1.2 Finish Calibration“.

7.5.4 mV Calibration (Only for Analog Sensors)



Enter mV calibration mode as described in section 7.1 “Enter Calibration Mode“.

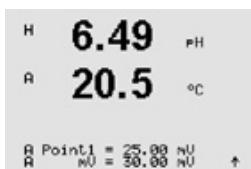

The user can now enter Point 1. The offset calibration factor is calculated by using the value of Point1 instead of the measured value (line 4, mV = ...) and displayed on the next screen.

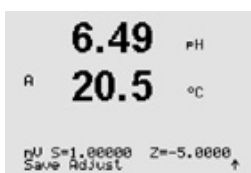

Z is the newly calculated offset calibration factor. The slope calibration factor S is always 1 and does not enter the calculation.

Select ADJUST or ABORT to finish calibration. See „7.1.2 Finish Calibration“.

7.5.5 ORP Calibration (Only for ISM Sensors)

In case that an pH sensor with solution ground based on ISM technology is connected to the M400, the transmitter gives the option to make in addition to the pH calibration an ORP calibration.



NOTE: In case of choosing ORP calibration the parameters defined for pH (see chapter 8.2.3.3 “pH/ORP Parameters”, PATH: Menu/Configure/Measurement/pH) will not be considered.



Enter ORP calibration mode as described in section 7.1 “Enter Calibration Mode“.

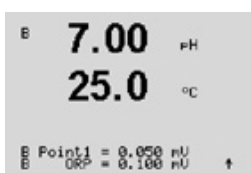

The user can now enter Point 1. In addition the actual ORP is displayed.

Press [ENTER] to proceed.

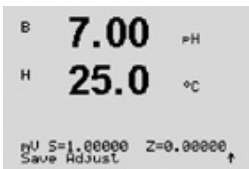

The display shows the slope calibration factor S and the offset calibration factor Z.

Select ADJUST, CALIBRATE or ABORT to finish calibration. See „7.1.2 Finish Calibration“.

7.6 Carbon Dioxide Calibration (Only for ISM Sensors)

For dissolved carbon dioxide (CO₂) sensors, the M400 transmitter features one-point, two-point (Auto or Manual mode) or process calibration. For the one-point or two-point calibration the solution with pH = 7.00 and/or pH = 9.21 of the Mettler – 9 standard buffer can be used (see section 8.2.3.8 “Dissolved Carbon Dioxide Parameters”) or the buffer value can be entered manually.

7.6.1 One-Point Calibration

Enter CO₂ calibration mode as described in section 7.1 “Enter Calibration Mode“.



Select 1 point Calibration. With CO₂ sensors a one-point calibration is always performed as a offset calibration.



Depending on the parameterized Drift control (see section 8.2.3.8 “Dissolved Carbon Dioxide Parameters”) one of the two following modes is active.

7.6.1.1 Auto Mode

Place the electrode in the buffer solution and press the [ENTER] key to start the calibration.

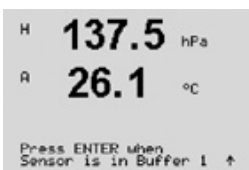

The display shows the buffer the transmitter has recognized (Point 1) and the measured value.



As soon as the stabilisation criteria have been fulfilled the display changes to show the slope calibration factor S and the offset calibration factor Z.



Select ADJUST, CALIBRATE or ABORT to finish calibration. See „7.1.2 Finish Calibration“.

7.6.1.2 Manual Mode

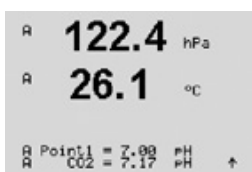

Place the electrode in the buffer solution. The display shows the buffer the transmitter has recognized (Point 1) and the measured value. Press [ENTER] to proceed.

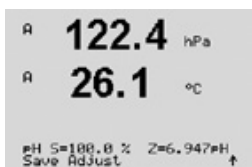

The display shows now the slope calibration factor S and the offset calibration factor Z.

Select ADJUST, CALIBRATE or ABORT to finish calibration. See „7.1.2 Finish Calibration“.

7.6.2 Two-Point Calibration



Enter CO₂ calibration mode as described in section 7.1 “Enter Calibration Mode”.

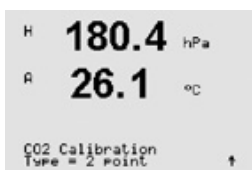

Select 2 Point calibration.

Depending on the parameterized Drift control (see section 8.2.3.8 “Dissolved Carbon Dioxide Parameters”) one of the two following modes is active.

7.6.2.1 Auto Mode

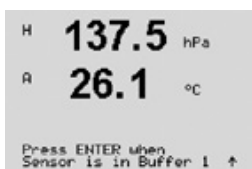

Place the electrode in the first buffer solution and press the [ENTER] key to start the calibration.

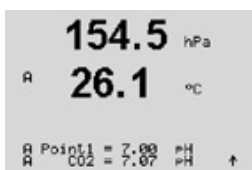

The display shows the buffer the transmitter has recognized (Point 1) and the measured value.

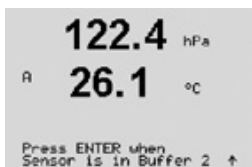

As soon as the stabilisation criteria have been fulfilled, the display changes and prompts you to place the electrode in the second buffer.

Place the electrode in the second buffer solution and press the [ENTER] key to go on with the calibration.

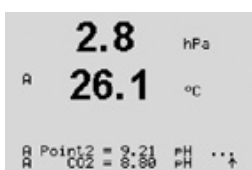

The display shows the second buffer the transmitter has recognized (Point 2) and the measured value.



As soon as the stabilisation criteria have been fulfilled, the display changes to show the slope calibration factor S and the offset calibration factor Z.

Select ADJUST, CALIBRATE or ABORT to finish calibration. See „7.1.2 Finish Calibration“.

7.6.2.2 Manual Mode



Place the electrode in the first buffer solution. The display shows the buffer the transmitter has recognized (Point 1) and the measured value. Press [ENTER] to proceed.

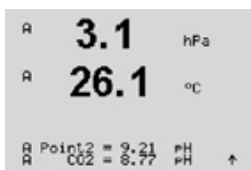

Place the electrode in the second buffer solution. The display shows the buffer the transmitter has recognized (Point 2) and the measured value. Press [ENTER] to proceed.



The display shows the slope calibration factor S and the offset calibration factor Z.

Select ADJUST, CALIBRATE or ABORT to finish calibration. See „7.1.2 Finish Calibration“.

7.6.3 Process Calibration



Enter CO₂ calibration mode as described in section 7.1 “Enter Calibration Mode“.



Select Process calibration. With CO₂ sensors a process calibration is always performed as a offset calibration.

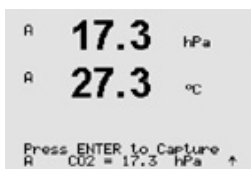

Take a sample and press the [ENTER] key again to store the current measuring value. To show the ongoing calibration process, A or B (depending on the channel) is blinking in the display. After determining the CO₂ value of the sample, press the ► key again to proceed with the calibration.

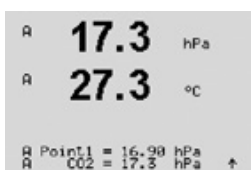

Enter the CO₂ value of the sample then press the [ENTER] key to start calibration.

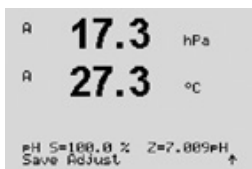

The display shows the slope calibration factor S and the offset calibration factor Z.

Select ADJUST, CALIBRATE or ABORT to finish calibration. See „7.1.2 Finish Calibration“.

7.7

Sensor Temperature Calibration (Only for Analog Sensors)

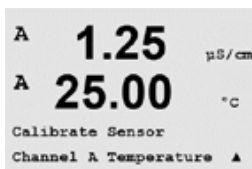

Enter Sensor calibration mode as described in section 7.1 “Enter Calibration Mode” and select Temperature.

7.7.1

One-Point Sensor Temperature Calibration

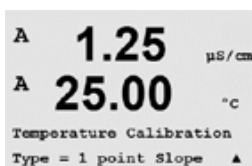

Select 1 point calibration. Slope or Offset can be selected with the 1 Point calibration. Select Slope to recalculate the Slope factor M (Multiplier) or Offset to recalculate the offset calibration factor A (Adder).

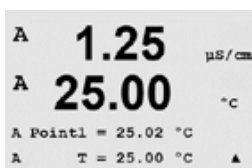

Enter the value for Point 1 and press [ENTER].



Select ADJUST or ABORT to finish calibration. See „7.1.2 Finish Calibration“.

7.7.2

Two-Point Sensor Temperature Calibration



Select 2 Point as calibration type.

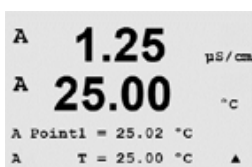

Enter the value for Point 1 and press [ENTER].

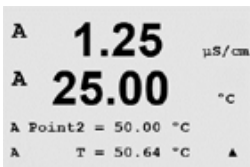

Enter the value for Point 2 and press [ENTER].



Select ADJUST or ABORT to finish calibration. See „7.1.2 Finish Calibration“.

7.8

Edit Sensor Calibration Constants (Only for Analog Sensor)



Enter Calibration mode as described in section 7.1 “Enter Calibration Mode” and select Edit, Edit pH, Edit mV.

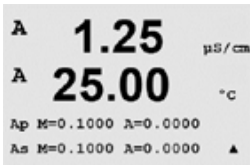

All calibration constants for the selected sensor channel are displayed. Primary measurement constants (p) are displayed on Line 3. Secondary measurement (temperature) constants (s) for the sensor are displayed on Line 4.

The calibration constants can be changed in this menu.

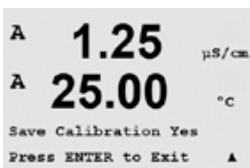

Select Yes to save the new calibration values and the successful calibration is confirmed on the display.



NOTE: Each time a new analog conductivity sensor is connected to the M400 Type 1, 2 transmitter, it is necessary to enter the unique calibration data (cell constant and offset) located on the sensor label.

7.9

Sensor Verification

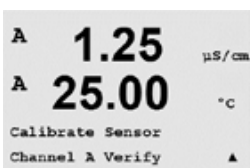

Enter Calibration mode as described in section 7.1. “Enter Calibration Mode” and select Verify.

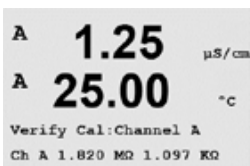

The measured signal of the primary and the secondary measurement in electrical units are shown. The meter calibration factors are used when calculating these values.

Press [ENTER] to exit from this display.

8 Configuration

(PATH: Menu/Configure)

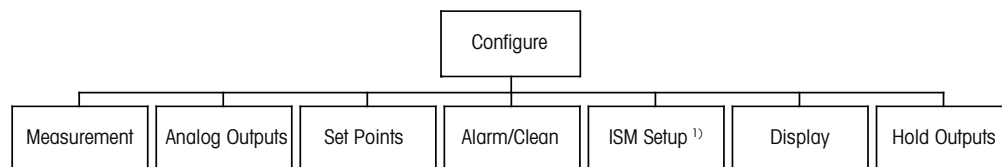

1) Only available in combination with ISM sensors

8.1 Enter Configuration Mode



While in Measurement mode, press the ◀ key. Press the ▲ or ▼ key to navigate to the Configure – menu and press [ENTER].

8.2 Measurement

(PATH: Menu/Configure/Measurement)

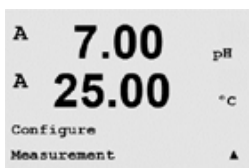

Enter configuration mode as described in Section 8.1 "Enter configuration mode".

Press the [ENTER] key to select this menu. The following sub menus can now be selected: Channel Setup, Temperature Source, Comp/pH/O₂ and Set Averaging.

8.2.1 Channel Setup

(PATH: Menu/Configure/Measurement/Channel Setup)

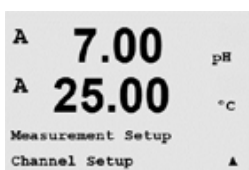

Press the [ENTER] key to select the "Channel Setup" menu.

Depending on the connected sensor (analog or ISM) the channel can be chosen.

8.2.1.1 Analog Sensor

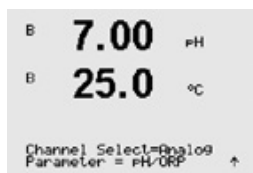

Select sensor type Analog and press [ENTER].

Available measurement types are (depends on transmitter type):

Measurement parameter	Description	Transmitter		
		M400/2H	M400/2XH	M400G/2XH
pH/ORP	pH or ORP	•	•	•
Cond (2)	2 electrode conductivity	•	•	•
Cond (4)	4 electrode conductivity	•	•	•
O ₂ hi	Dissolved oxygen (ppm)	•	•	•
O ₂ lo	Dissolved oxygen (ppb)	•	•	•
O ₂ Trace	Dissolved oxygen (trace)	•	•	•
O ₂ hi	Oxygen in gas (ppm)	–	–	•

The 4 lines of the display can now be configured with sensor channel "A" for each line of the display as well as measurements and unit multipliers. Pressing the [ENTER] key will display the selection for lines a, b, c and d.

8.2.1.2 ISM Sensor



Select sensor type ISM and press [ENTER].

If an ISM sensor is connected, the transmitter automatically (Parameter = Auto) Recognizes the type of sensor. You can also fix the transmitter to a certain measurement parameter e.g. "pH", depending on the type of transmitter you have.

Measurement parameter	Description	Transmitter		
		M400/2H	M400/2XH	M400G/2XH
pH/ORP	pH or ORP	•	•	•
pH/pNa	pH and ORP (with pH/pNa electrode)	•	•	•
Cond (4)	4 electrode conductivity	•	•	•
O ₂ hi	Dissolved oxygen (ppm)	•	•	•
O ₂ lo	Dissolved oxygen (ppb)	•	•	•
O ₂ Trace	Dissolved oxygen (trace)	•	•	•
O ₂ hi	Oxygen in gas (ppm)	–	–	•
O ₂ hi	Oxygen in gas (ppb)	–	–	•
O ₂ Trace	Oxygen in gas (trace)	–	–	•
O ₂ Opt	Dissolved optical oxygen (ppm, ppb)	•	•	•
CO ₂ lo	Dissolved carbon dioxide	•	•	•

The 4 lines of the display can now be configured with sensor channel "A" for each line of the display as well as measurements and unit multipliers. Pressing the [ENTER] key will display the selection for lines a, b, c and d.



NOTE: Beside the measurement values pH, O₂, T, etc. also the ISM values DLI, TTM and ACT can be assigned to the different lines and linked to the analog outputs (see chapter 8.3 "Analog Outputs") or set points (see chapter 8.4 "Set Points")

8.2.1.3 Save Changes of the Channel Setup

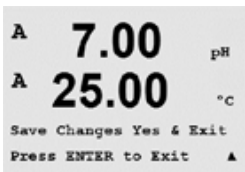

After the procedure of the channel setup described in the previous chapter pressing the [ENTER] key again will bring up the Save Changes dialog. Selecting No will discard the entered values and return to the measurement display screen, selecting Yes will save changes made.

8.2.2 Temperature Source (Only for Analog Sensors)

(PATH: Menu/Configure/Measurement/Temperature Source)



Enter Measurement as described in chapter 8.2 "Measurement". Select Temperature Source by using the ▲ or ▼ key and press [ENTER].



The following options can be chosen:

- Auto: The transmitter automatically recognizes the temperature source.
- Use NTC22K: Input will be taken from the sensor attached.
- Use Pt1000: Temperature input will be taken from the sensor attached
- Use Pt1 00: Input will be taken from the sensor attached.
- Fixed = 25 °C: Allows a specific temperature value to be entered. It must be chosen when customer use pH sensor without temperature source.



NOTE: If temperature source is set to Fixed, the temperature applied during one-point and/or two-point calibration of pH electrodes can be adjusted within the corresponding calibration procedure. After the calibration the fixed temperature defined in this configuration menu is valid again.

Pressing the [ENTER] key will bring up the Save Changes dialog.

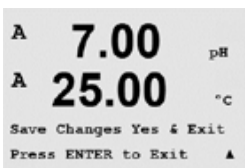

Selecting No will discard the entered values and return to the measurement display screen, selecting Yes will save changes made.

8.2.3 Parameter Related Settings

(PATH: Menu/Configure/Measurement/pH)

Additional measurement and calibration parameters can be set for each parameter; conductivity, pH, and O₂.



NOTE: Use pH menu for settings of pH/pNa sensors.

Enter Configuration Mode as described in section 8.1 "Enter Configuration mode" and select the menu Measurement (see section 8.2 "Measurement").

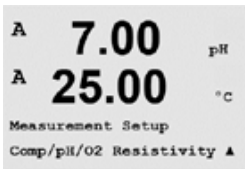

Depending on the connected sensor, the menu pH, O₂, can be selected by using the A or ▼ key. Press [ENTER]

For more details, please see the following explanations depending on the selected parameter.

8.2.3.1 Conductivity Temperature Compensation

If during the channel setup (see chapter 8.2.1 "Channel Setup") the parameter conductivity has been chosen or an four-electrode conductivity sensor based on ISM technology is connected to the transmitter, the temperature compensation mode can be selected. Temperature compensation should be matched to the characteristics of the application. The transmitter considers this value for the temperature compensation by calculating and displaying the result for the measured conductivity.



NOTE: For calibration purposes the temperature compensation as defined at the menu "Cal/Compensation" for the buffers resp. samples will be considered (see also chapter 7.2 "Conductivity Calibration for Two- or Four-Electrode Sensors" resp)

For doing this adjustment the menu "Resistivity", that will be displayed, has to be chosen. (see chapter 8.2.3 "Parameter Related Settings")

The first two measurement lines are displayed on the screen. This chapter described the procedure for the first measurement line. By using the key ► the second line will be chosen. To select the 3rd and 4th line press [ENTER]. The procedure itself works at every measurement line in the same way.

Choices are "Standard", "Lin 25 °C" and "Lin 20 °C".



Standard compensation includes compensation for non-linear high purity effects as well as conventional neutral salt impurities and conforms to ASTM standards D1125 and D5391.

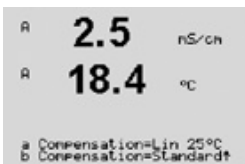

Lin 25 °C compensation adjusts the reading by a factor expressed as a "% per °C" (deviation from 25 °C). Use only if the solution has a well-characterized linear temperature coefficient.

The factory default setting is 2.0 % / °C.

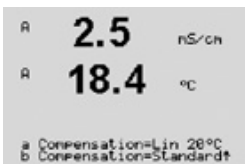

Lin 20 °C compensation adjusts the reading by a factor expressed as a "% per °C" (deviation from 20 °C). Use only if the solution has a well-characterized linear temperature coefficient.

The factory default setting is 2.0 % / °C

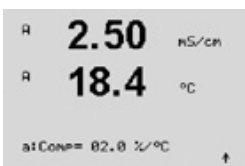

If compensation mode "Lin 25 °C" or "Lin 20 °C" has been chosen, the factor for the adjustment of the reading can be modified after pressing [ENTER] (If working at measurement line 1 or 2 press [ENTER] twice).

Adjust the factor for temperature compensation.

Pressing [ENTER] will bring up the Save Changes dialog. Selecting No will discard the entered values and return to the measurement display screen, selecting Yes will save changes made.

8.2.3.2 Concentration Table

If during the channel setup (see chapter 8.2.1 "Channel Setup") the parameter conductivity has been chosen or an four-electrode conductivity sensor based on ISM technology is connected to the transmitter, a concentration table can be defined.

To specify customers-specific solutions, up to 9 concentration values can be edited in a matrix together with up to 9 temperatures. To do so the desired values are edited under the concentration table menu. Furthermore the conductivity values for the according temperature and concentration values are edited.

For doing the settings the menu "Concentration Table", that will be displayed, has to be chosen. (see chapter 8.2.3 "Parameter Related Settings").



Define the desired **unit**.

Press [ENTER]



NOTE: Refer to section 8.2.1 "Channel Setup" to choose the unit used in the display.

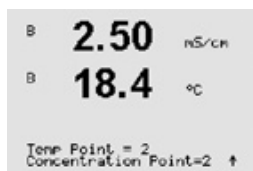

Enter the amount of desired temperature points (**Temp Point**) and **Concentration Points**.

Press [ENTER]

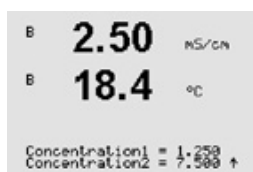

Enter the values for the different concentrations (**ConcentrationX**).

Press [ENTER]



Enter the value of the 1st temperature (**Temp1**) and the value for the conductivity which belongs to the first concentration at this temperature.

Press [ENTER]

Enter the value for the conductivity which belongs to the second concentration at the first temperature and press [ENTER] etc.

After entering all conductivity values, that belong to the different concentrations at the first temperature point, enter in the same way the value of the 2nd temperature point (**Temp2**) and the conductivity value which belongs at the second temperature to the first concentration. Press [ENTER] and go on in the same way for the next concentration points as described for the first temperature point.

Enter in this way the values at every temperature point. After entering the last value, pressing [ENTER] again will bring up the Save Changes dialog. Selecting No will discard the entered values and return to the measurement display screen, selecting Yes will save changes made.



NOTE: The values for the temperature have to increase from Temp1 to Temp2 to Temp3 etc. The values for the concentration have to increase from Concentration1 to Concentration2 to Concentration3 etc.



NOTE: The conductivity values at the different temperatures have to increase or decrease from Concentration1 to Concentration2 to Concentration3 etc. Maxima and/or minima are not permitted. If the conductivity values at Temp1 are increasing with the different concentrations, they have to increase also at the other temperatures. If the conductivity values at Temp1 are decreasing with the different concentrations, they have to decrease also at the other temperatures.

8.2.3.3 pH/ORP Parameters

If during the channel setup (see chapter 8.2.1 "Channel Setup") the parameter pH/ORP has been chosen or an pH sensor based on ISM technology is connected to the transmitter, the parameters drift control, buffer recognition, STC, IP, fixed Calibration temperature and the displayed units for slope and zero point can be set resp. adjusted.

For doing this adjustments resp. settings the menu "pH", that will be displayed, has to be chosen. (see chapter 8.2.3 "Parameter Related Settings").



Select the **drift control** for calibration as Auto (drift and time criteria have to be fulfilled) or manual (The user can decide when a signal is stable enough to complete calibration) followed by the relevant buffer table for the automatic buffer recognition. If the drift rate is less than 0.4 mV over a 19 second interval then the reading is stable and the calibration is done using the last reading. If the drift criteria is not met within 300 seconds then the calibration times out and the message "Calibration Not Done" Press ENTER Enter to "Exit" is displayed.

Press [ENTER]

For automatic **buffer recognition** during calibration, select the buffer solution set that will be used: Mettler-9, Mettler-10, NIST Tech, NIST Std = JIS Std, HACH, CIBA, MERCK, WTW, JIS Z 8802 or None. See Section 19 "Buffer tables" for buffer values. If the auto buffer feature will not be used or if the available buffers are different from those above, select None. Press [ENTER].



NOTE: For dual membrane pH electrodes (pH/pNa) only buffer Na+ 3.9M (see section 19.2.1 "Mettler-pH/pNa buffers") is available.

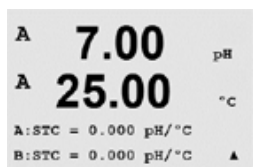

STC is the solution temperature coefficient in units of pH/°C referenced to 25 °C (Default = 0.000 for most applications). For pure waters, a setting of 0.016 pH/°C should be used. For low conductivity power plant samples near 9 pH, a setting of 0.033 pH/°C should be used. These positive coefficients compensate for the negative temperature influence on the pH of these samples. Press [ENTER].



IP is the isothermal point value (Default = 7.000 for most applications). For specific compensation requirements or non standard inner buffer value, this value can be changed. Press [ENTER].



STC RefTemp sets the temperature to which solution temperature compensation is referenced. The displayed value and the output signal is referenced to STC RefTemp. Selecting "No" means solution temperature compensation is not used. The most common reference temperature is 25 °C. Press [ENTER].



The units for the slope and the zero point, that will be shown on the display can be chosen. The default setting for the unit of the slope is [%] and can be changed to [pH/mV]. For the zero point the default setting of the unit is [pH] and can be changed to [mV]. Use the ► key to move to the input field and select the unit by using the ▲ or ▼ key.

Pressing [ENTER] again will bring up the Save Changes dialog. Selecting No will discard the entered values and return to the measurement display screen, selecting Yes will save changes made.

8.2.3.4 Parameters for Oxygen Measurement Based on Amperometric Sensors

If during the channel setup (see chapter 8.2.1 "Channel Setup") the parameter O₂ hi, O₂ lo or O₂ Trace has been chosen or an oxygen sensor based on ISM technology is connected to the transmitter, the parameters calibration pressure, process pressure, ProcCalPres, salinity and relative humidity can be set resp. adjusted. If an ISM sensor is connected, there is furthermore the option to adjust the parameterization voltage.

For doing this adjustments resp. settings the menu "O₂", that will be displayed, has to be chosen. (see chapter 8.2.3 "Parameter Related Settings")



Enter the Calibration pressure in line 3. The default value for CalPres is 759.8 and the default unit is mmHg.

Select Edit in line 4 for entering the applied process pressure manually. Select Ain if an analog input signal is used for the applied process pressure. Press [ENTER]



NOTE: The menu Ain can only be selected if the transmitter is configured for an ISM sensor.



If Edit has been chosen an input field for entering the value manually is displayed. In case that Ain has been selected the start value (4 mA) and the end value (20 mA) of the range for the 4 to mA input signal have to be entered.

Press [ENTER]



For the algorithm of the process calibration the applied pressure (ProcCalPres) has to be defined. The value of the process pressure (ProcPres) or the calibration pressure (CalPres) can be used. Chose the pressure, that applies during the process calibration, resp. should be used for the algorithm.

Select the required Drift Control of the measuring signal during the calibration procedure. Choose Manual if the user will decide when a signal is stable enough to complete the calibration. Select Auto and an automatic stability control of the sensor signal during calibration through the transmitter will be done. Press [ENTER]

In the next step the salinity of the measured solution can be modified.



In addition the relative humidity of the calibration gas can also be entered. The allowed values for relative humidity are in the range 0 % to 100 %. When no humidity measurement is available, use 50 % (default value).

Press [ENTER]

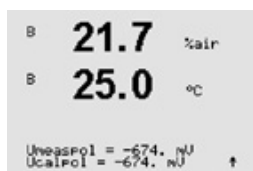

If an ISM sensor has been connected resp. configured there is furthermore the option to adjust the polarization voltage for the sensor. Different value can be entered for the measuring mode (Umeaspol) and for the calibration mode (Ucalpol). For entered values 0 mV to –550 mV the connected sensor will be set to a polarization voltage of –500mV. If the entered value is less than –550 mV, the connected sensor will set to a polarization voltage of –674 mV.



NOTE: During a process calibration, the polarization voltage Umeaspol, defined for the measuring mode, will be used.



NOTE: If a one point calibration is executed, the transmitter sends the polarization voltage, valid for the calibration, to the sensor. If the polarization voltage for the measuring mode and calibration mode is different, the transmitter will wait 120 seconds before starting the calibration. In this case the transmitter will also go after the calibration for 120 seconds to the HOLD Mode, before returning to the measuring mode again.

Press [ENTER]



The display shows the Save Changes dialog. Selecting No will discard the entered values and return to the measurement display screen, selecting Yes will save changes made.

8.2.3.5 Parameters for Oxygen Measurement Based on Optical Sensors

If during the channel setup (see section 8.2.1 “Channel Setup”) the parameter O₂ Opt has been chosen, the parameters calibration pressure, process pressure, ProCalPres, salinity, drift control and relative humidity can be set resp. adjusted.

For doing these adjustments the menu “O₂ optical”, that will be displayed, has to be chosen. (see section 8.2.3 “Parameter Related Settings”)

Press [ENTER]



Enter the calibration pressure (line 3). The default value for CalPres is 759.8 and the default unit is mmHg.

Select Edit in line 4 for entering the applied process pressure manually. Select Ain if an analog input signal is used for the applied process pressure. Press [ENTER]



If Edit has been chosen an input field for entering the value manually is displayed. In case that Ain has been selected the start value (4 mA) and the end value (20 mA) of the range for the 4 to 20 mA input signal have to be entered.

Press [ENTER]



NOTE: Refer to section 4.6.1 “pH, Amperometric Oxygen, Conductivity (4-e) and Dissolved Carbon Dioxide ISM Sensors”.



For the algorithm of the process calibration the applied pressure (ProcCalPres) has to be defined. The value of the process pressure (ProcPres) or the calibration pressure (CalPres) can be used. Chose the pressure, that applies during the process calibration, resp. should be used for the algorithm.

Select the drift control for calibration as Auto (drift and time criteria have to be fulfilled) or manual (The user can decide when a signal is stable enough to complete calibration). If Auto is selected, the drift is checked by the sensor. If the drift criteria is not met within a defined time (depending on the sensor model) the calibration times out and the message "Calibration Not Done" Press ENTER Enter to "Exit" is displayed.

Press [ENTER]

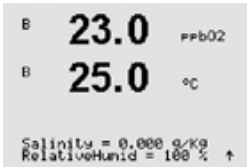

In the next step the salinity of the measured solution can be modified.

In addition the relative humidity of the calibration gas can also be entered. The allowed values for relative humidity are in the range 0% to 100%. When no humidity measurement is available, use 50% (default value).

Press [ENTER]

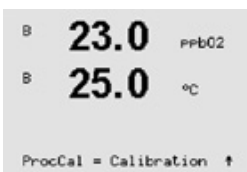

Select through the parameter **ProcCal** between Scaling and Calibration for process calibration. If Scaling has been chosen, the calibration curve of the sensor will be untouched, but the output signal of the sensor will be scaled. In case of calibration value <1%, the offset of the sensor output signal will be modified during scaling, for value >1% the slope of the sensor output will be adjusted. For further information about scaling refer to the sensor manual.

Pressing the [ENTER] key again will bring up the Save Changes dialog. Selecting No will discard the entered values and return to the measurement display screen, selecting Yes will save changes made.

8.2.3.6 Adjusting Sampling Rate for Optical Sensors

If during the channel setup (see section 8.2.1 "Channel Setup") the parameter O₂ Opt has been chosen the parameter O₂ opt sampling rate can be adjusted.

For doing this adjustment the menu "O₂ opt sampling rate" has to be chosen (see section 8.2.3 "Parameter Related Settings").

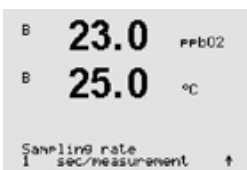

The time interval from one measuring cycle of the sensor to the other can be adjusted i.e. adapted to the application. A higher value will increase the life time of the OptoCap of the sensor.

Pressing the [ENTER] key will bring up the Save Changes dialog. Selecting No will discard the entered values and return to the measurement display screen, selecting Yes will save changes made.

8.2.3.7 LED Mode

If during the channel setup (see section 8.2.1 "Channel Setup") the parameter O₂ Opt has been chosen the parameters LED, T off, DI 1 LED control can be set resp. adjusted.

For doing these adjustments the menu "LED Mode" has to be chosen (see section 8.2.3 "Parameter Related Settings").



The operation mode for the LED of the sensor can be selected. There are the following options.

Off: LED is permanently switched off.

On: LED is permanently switched on.

Auto: The LED is switched on as long as the measured media temperature is smaller than Toff (see next value) or switched off thru the digital input signal (see over next value).



NOTE: If the LED is switched off, no oxygen measurement is performed.

Press [ENTER]

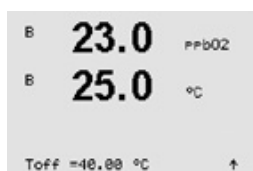

Depending on the measured media temperature the LED of the sensor can be automatically switched off. If the media temperature is higher than Toff, the LED will be switched off. The LED will be switched on as soon as the media temperature falls below Toff – 3K. This function gives the option to increase the lifetime of the OptoCap by switching off the LED thru SIP or CIP cycles.



NOTE: This function is only active if the operation mode of the LED is set to "Auto".

Press [ENTER]



The operation mode of the sensor LED can also be influenced by the digital input signal DI1 of the transmitter. If the parameter "DI 1 LED control" is set to Yes, the LED is switched off, if DI1 is active. If "DI 1 LED control" is set to No, the signal of DI1 has now influence on the operation mode of the sensor LED.

This function is helpful for remote control of the sensor thru a SPS or DCS.



NOTE: This function is only active if the operation mode of the LED is set to "Auto".

Pressing the [ENTER] key will bring up the Save Changes dialog. Selecting No will discard the entered values and return to the measurement display screen, selecting Yes will save changes made.

8.2.3.8 Dissolved Carbon Dioxide Parameters

If during the channel setup (see section 8.2.1 "Channel Setup") the parameter CO₂ has been chosen, the parameters drift control, salinity, HCO₃, TotPres and the displayed units for slope and zero point can be set resp. adjusted.

For doing this adjustment resp. settings the menu "CO₂", that will be displayed, has to be chosen. (see section 8.2.3 "Parameter Related Settings")

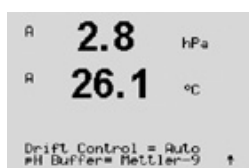

Select **Drift Control** for calibration as Auto (drift and time criteria have to be fulfilled) or manual (the user can decide when a signal is stable enough to complete calibration) followed by the relevant buffer table for the automatic buffer recognition. If the drift rate is less than 0.4 mV over a 19 second interval then the reading is stable and the calibration is done using the last reading. If the drift criteria is not met within 300 seconds then the calibration times out and the message "Calibration Not Done Press ENTER to Exit" is displayed.

For automatic **buffer recognition** during calibration, select the buffer Mettler-9. Use for calibration purposes solution with pH = 7.00 and/or pH = 9.21. If the auto buffer feature will not be used or if the available buffers are different from those above, select None. Press [ENTER] to go on.

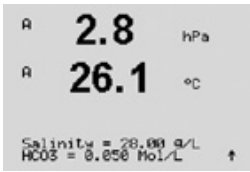

The **Salinity** describes the total amount of solved salts in the CO₂ electrolyte of the sensor connected to the transmitter. It is a sensor specific parameter. The default value (28.00 g/L) is valid for the InPro 5000. Do not change this parameter if the InPro 5000 will be used.

The parameter **HCO₃** describes the concentration of hydrogen carbonate in the CO₂ electrolyte of the sensor connected to the transmitter. It is also a sensor specific parameter. The default value 0.050 Mol/L is valid for the InPro 5000. Do not change this parameter if the InPro 5000 will be used.

To go on press [ENTER] again.



If the unit for the measured dissolved carbon dioxide is %sat, the pressure during the calibration resp. measurement has to be considered. This will be done by setting the parameter TotPres. If another unit than %sat has been selected, the result will not be influenced by this parameter.

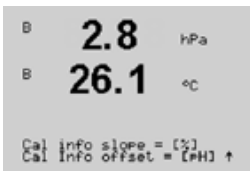

The units for the slope and the zero point, that will be shown on the display can be chosen. The default setting for the unit of the slope is [%] and can be changed to [pH/mV]. For the zero point the default setting of the unit is [pH] and can be changed to [mV]. Use the ► key to move to the input field and select the unit by using the ▲ or ▼ key.

Pressing [ENTER] again will bring up the Save Changes dialog. Selecting No will discard the entered values and return to the measurement display screen, selecting Yes will save changes made.

8.2.4 Set Averaging

Enter Configuration Mode as described in section 8.1 "Enter Configuration mode" and select the menu Measurement (see section 8.2 "Measurement").



Selected the menu "Set Averaging" by using the ▲ or ▼ key. Press [ENTER]

The averaging method (noise filter) for each measurement line can now be selected. The options are Special (Default), None, Low, Medium and High:

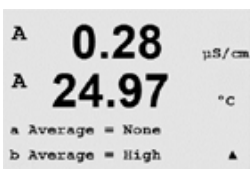

- None = no averaging or filtering
- Low = equivalent to a 3 point moving average
- Medium = equivalent to a 6 point moving average
- High = equivalent to a 10 point moving average
- Special = averaging depending on signal change (normally High averaging but Low averaging for large changes in input signal)

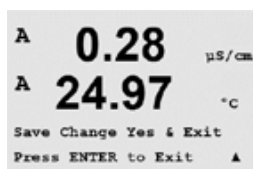

Pressing the [ENTER] key again will bring up the Save Changes dialog. Selecting No will discard the entered values and return to the measurement display screen, selecting Yes will save changes made.

8.3 Analog Outputs

(PATH: Menu/Configure/Analog Outputs)

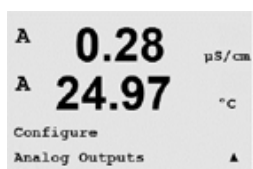

Enter Configuration mode as described in Section 8.1. "Enter Configuration Mode" and navigate to the menu "Analog Outputs" by using the ▲ or ▼ key.

Press the [ENTER] key to select this menu, which lets you configure the 4 analog outputs.

Once analog outputs have been selected, use the ◀ and ▶ buttons to navigate between configurable parameters. Once a parameter is selected, its setting can be selected per the following table:

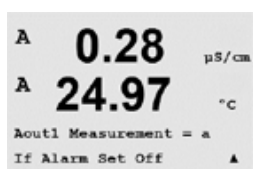

When an alarm value is selected (see chapter 8.5.1 "Alarm"; PATH: Menu/Configure/Alarm/Clean/Setup Alarm), the analog output will go to this value if any of these alarm conditions occurs.

With the "Aout1 Measurement = a" parameter the analog output 1 is assigned to the measured value "a". With the "Aout2 Measurement = b" parameter the analog output 2 is assigned to the measured value "b".



NOTE: Beside the measurement values pH, O₂, T, etc. also the ISM values DLI, TTM and ACT can be linked to the analog outputs if they have been assigned to the corresponding line in the display (see chapter 8.2.1.2 "ISM Sensor")

With the "If Alarm Set" parameter the current is set to 3.6 mA or 22.0 mA (default) in case of an alarm.

The "AoutX Type" parameter is "Normal". The "AoutX Range" parameter is "4–20 mA".

Enter the minimum and maximum value of Aout.

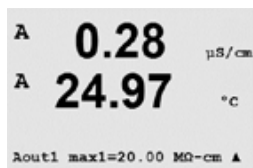
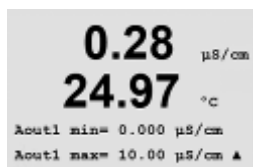

If Auto-Range was selected then Aout max1 can be configured. Aout max1 is the maximum value for the first range on auto-range. The maximum value for the second range on auto-range was set in the previous menu. If Logarithmic Range was selected, it will also prompt for the number of decades as "Aout1 # of Decades =2".



The value for the Hold mode can be configured to hold the last value or can be set to a fixed value.

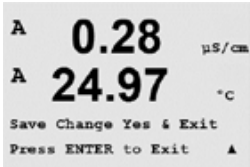

Pressing the [ENTER] key again will bring up the Save Changes dialog. Selecting No will discard the entered values and return to the measurement display screen, selecting Yes will save changes made.

8.4

Set Points

(PATH: Menu/Configure/Set Points)



Enter Configuration mode as described in Section 8.1. "Enter Configuration Mode" and navigate to the menu "Set Points" by using the ▲ or ▼ key.

Press the [ENTER] key to select this menu.

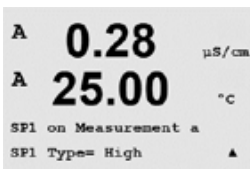

Up to 6 setpoints can be configured on any of the measurements (a thru d). The possible Set-point types are Off, High, Low, Outside (<->) and Between (>-<).

An "Outside" setpoint will cause an alarm condition whenever the measurement goes above its high limit or below its low limit. A "Between" setpoint will cause an alarm condition to occur whenever the measurement is between its high and low limits.

Enter the desired value(s) for the setpoint and press [ENTER]



NOTE: Beside the measurement values pH, O₂, T, etc. also the ISM values DLI, TTM and ACT can be linked to the set points if they have been assigned to the corresponding line in the display (see chapter 8.2.1.2 "ISM Sensor").



Depending on the defined setpoint type, this screen provides the option to adjust the values for the setpoint(s).

Press [ENTER] to proceed.



Out of Range

Once configured, the selected OC will be activated if a sensor Out of Range condition is detected on the assigned input channel. Select the setpoint and "Yes" or "No". Select the desired OC that will activate when the setpoint alarm condition is reached.

Press [ENTER]

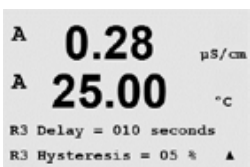

Delay

Enter the delay time in seconds. A time delay requires the setpoint to be exceeded continuously for the specified length of time before activating the OC. If the condition disappears before the delay period is over, the OC will not be activated.

Hysteresis

Enter value for the hysteresis. A hysteresis value requires the measurement to return within the setpoint value by a specified hysteresis before the OC is deactivated.

For a high setpoint, the measurement must decrease more than the indicated hysteresis below the setpoint value before the OC is deactivated. With a low setpoint, the measurement must rise at least this hysteresis above the setpoint value before the OC is deactivated. For example, with a high setpoint of 100 and hysteresis of 10, when this value is exceeded, the measurement must fall below 90 before the OC is deactivated.

Press [ENTER]

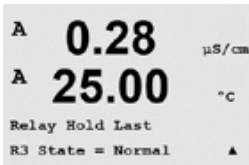

Hold

Enter the OC Hold Status of "Last", "On" or "Off". This is the state the OC will go to during a hold status.

State

OC contacts are in normal state until the associated setpoint is exceeded, then the OC is activated and the contact states change.

Select "Inverted" to reverse the normal operating state of the OC (i.e. normally high voltage state is in a low voltage state until the setpoint is exceeded). "Inverted" OC operation is functional vice versa. All OCs can be configured.

Pressing the [ENTER] key again will bring up the Save Changes dialog. Selecting No will discard the entered values and return to the measurement display screen, selecting Yes will save changes made.

8.5 Alarm/Clean

(PATH: Menu/Configure/Alarm/Clean)

Enter configuration mode as described in Section 8.1 "Enter Configuration Mode".

This menu allows the configuration of alarm and clean functionality.



8.5.1 Alarm



To select "Setup Alarm", press the ▲ or ▼ key so that "Alarm" is flashing.

Using the ◀ and ▶ buttons, navigate to "Use OC #". Using the ▲ or ▼ keys, select a OC to be used for the alarm and press [ENTER].

One of the following events may be alarmed:

1. Power failure
2. Software failure
3. Rg diagnostics – pH glass membrane resistance (only for pH; pH/pNa Rg diagnostics detect both pH and pNa membrane glasses)
4. Rr diagnostics – pH reference resistance (only for pH sensors; except pH/pNa)
5. Cond cell open (only for analogue cond 2-e/4-e sensors)
6. Cond cell shorted (only for analogue cond 2-e/4-e sensors)
7. Channel B disconnected (only for ISM sensors)
8. Dry Cond sensor (only for ISM cond sensors)
9. Cell deviation (only for ISM cond sensors)
10. Electrolyte low (only for ISM amperometric oxygen sensors)

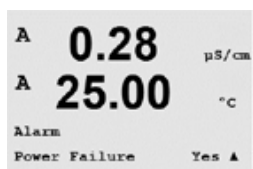

If any of these criteria are set to Yes and the conditions for an alarm are given, the flashing symbol ▲ will be shown in the display, an alarm message will be recorded (see also chapter 12.1 "Messages"; PATH: Info/Messages) and the selected OC will be activated. Furthermore an alarm can be indicated by the current output if this has been parameterized (see chapter 8.3 "Analog outputs"; PATH: Menu/Configure/Analog Outputs)

The conditions for alarms are:

1. There is a power failure or power cycling
2. The software watchdog performs a reset
3. Rg is out of tolerance – for example, broken measuring electrode (only for pH; pH/pNa Rg diagnostics detect both pH and pNa membrane glasses)
4. Rr is out of tolerance – for example, coated or depleted reference electrode (only for pH sensors; except pH/pNa)
5. If the conductivity sensor is on air (for example in an empty pipe) (only for resistive Conductivity sensors)
6. If the conductivity sensor has a short cut (only for resistive conductivity sensors)
7. If no sensor is connected on channel B (only for ISM sensors)
8. If the conductivity sensor is on air (for example in an empty pipe) (only for ISM Conductivity sensors)
9. Cell constant (multiplier) is out of tolerance, i.e. has changed too much compared to the value thru the factory calibration (only for ISM conductivity sensors)
10. Electrolyte in the membrane body reaches such a low level that the connection between cathode and reference is disturbed, an immediate action must be taken e.g. exchange and filling the electrolyte

For 1 and 2 the alarm indicator will be turned off when the alarm message is cleared. It will reappear if the power is constantly cycling or if the watchdog is repeatedly resetting the system.

Only for pH sensors

For 3 and 4 the alarm indicator will go off if the message is cleared and the sensor has been replaced or repaired so that the Rg and Rr values are within specification. If the Rg or Rr message is cleared and Rg or Rr is still out of tolerance then the alarm will stay on and the message will reappear. The Rg and Rr alarm can be turned off by going into this menu and setting Rg diagnostics and/or Rr diagnostics to No. The message can then be cleared and the alarm indicator will be off even though Rg or Rr is out of tolerance.

```

A 0.28 µS/cm
A 25.00 °C
Relay State = Inverted
R2 Delay = 001 sec ▲

```

Each alarm OC can be configured in either a Normal or Inverted state. In addition, a Delay for the activation can be set. For more information, refer to Section 8.4 "Setpoints".

Pressing the [ENTER] key again will bring up the Save Changes dialog. Selecting No will discard the entered values, selecting Yes will make the entered values the current ones.



NOTE: There are additional alarms, which will be indicated in the display. See therefore in chapter 14 "Troubleshooting" the different warning- and alarm lists.

8.5.2 Clean

```

A 0.28 µS/cm
A 25.00 °C
Setup Clean
Use Relay # 1 ▲

```

Configure the OC to be used for the cleaning cycle.

The default value is OC 1.

```

A 0.28 µS/cm
A 25.00 °C
CleanInterval= 0.000 hrs
Clean Time = 0000 sec ▲

```

The cleaning interval can be set from 0.000 to 999.9 hours. Setting it to 0 turns the clean cycle off. The cleaning time can be 0 to 9999 seconds and must be smaller than the cleaning interval.

Select the desired OC state: Normal or Inverted.

```

A 0.28 µS/cm
A 25.00 °C
Relay State = Normal ▲

```

Pressing the [ENTER] key again will bring up the Save Changes dialog. Selecting No will discard the entered values and return to the measurement display screen, selecting Yes will save changes made.

8.6 ISM Set Up (Available for pH and Oxygen ISM Sensors)

(PATH: Menu/Configure/ISM Setup)

Enter Configuration mode as described in Section 8.1. "Enter Configuration Mode" and navigate to the menu "ISM set up" by using the ▲ or ▼ key. Press [ENTER]

8.6.1 Sensor Monitoring



Select the menu "Sensor Monitoring" by pressing [ENTER].

The sensor monitoring options can be turned on or off and every alarm can be assigned to a certain output OC. The following options are possible:

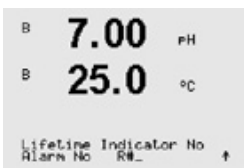

Lifetime indicator: The dynamic lifetime indication allows an estimation, when the pH electrode or the inner body of an amperometric oxygen sensors is at the end of his lifetime, based on the actual stress he is exposed to. The sensor permanently takes the averaged stress of the past days into consideration and is able to increase/decrease the lifetime accordingly.

Lifetime Indicator		YES/NO		YES/NO		choose OC
Alarm				R#		

The following parameters affect the lifetime indicator:

Dynamic parameters:

- Temperature
- pH or oxygen value
- Glass impedance (only pH)
- Reference impedance (only pH)

Static parameters:

- Calibration history
- Zero and Slope
- CIP/SIP/Autoclaving cycles

The sensor keeps the information stored in the built in electronics and can be retrieved via a transmitter or the iSense asset management suite.

The alarm will be reset if the Lifetime Indicator is not 0 days anymore (e.g. after connecting a new sensor or changing on the measurement conditions).

For amperometric oxygen sensors, the lifetime indicator is related to the inner-body of the sensor. After exchanging the inner-body, reset the lifetime indicator as described in chapter 8.6.5 "Reset ISM Counter/Timer".

If the Lifetime Indicator is turned on, in the measuring mode the value will be automatically shown in the display on line 3.

Press [ENTER]

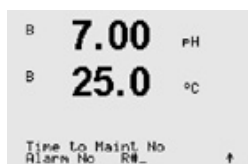

Time to Maintenance: This timer estimates when the next cleaning cycle should be performed to keep the best possible measurement performance. The timer is influenced by significant changes on the DLI parameters.

Time to Maintenance		YES/NO		YES/NO
Alarm		R#		choose OC

The time to maintenance can be reset to the initial value by the menu "Reset ISM Counter/Timer" (see chapter 8.6.5 "Reset ISM Counter/Timer"). For amperometric oxygen sensors, the time to maintenance indicates a maintenance cycle for the membrane and electrolyte.

Press [ENTER]



Activation of the **Adaptive Cal Timer:** This timer estimates when the next calibration should be performed to keep the best possible measurement performance. The timer is influenced by significant changes on the DLI parameters.

Adaptive Cal Timer		YES/NO		YES/NO
Alarm		R#		choose OC

The Adaptive Calibration Timer will be reset to his initial value after a successful calibration. After a successful calibration will also be the alarm reset. If the Adaptive Cal Timer is turned on, the value will be automatically shown in the display on line 4.

Press [ENTER]

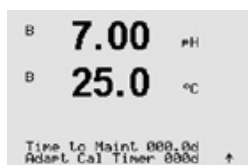

The initial value for Time to Maintenance as well as the Adaptive Calibration Timer can be modified according to the application experience and loaded down to the sensor.



NOTE: By connecting a sensor, the values for Time to Maintenance and/or Adaptive Calibration Timer are read out by the sensor.

Pressing the [ENTER] key again will bring up the Save Changes dialog. Selecting No will discard the entered values and return to the measurement display screen, selecting Yes will save changes made.

8.6.2 CIP Cycle Limit

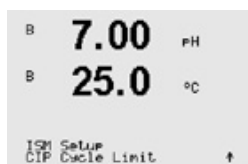

Navigate to the menu "CIP Cycle Limit" by using the ▲ and ▼ keys and press [ENTER].

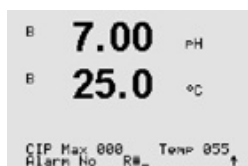

The CIP cycle limit counts the number of CIP cycles. If the limit (user defined) is reached, an alarm can be indicated and set to a certain output OC. The following options are possible:

CIP Max 000		YES/NO		Temp 055
Alarm		R#		choose OC

If the Max setting is on 000, the counter functionality is turned off. The alarm will be reset after exchanging the sensor. For oxygen sensors, the counter can be reset (see chapter 8.6.5 "Reset ISM Counter/Timer").

CIP characteristics: CIP Cycles will be automatically recognized by the sensor. Since CIP cycles will vary in intensity (duration and temperature) for each application the algorithm of the counter recognizes an increase of the measurement temperature above a adjustable limit (parameter **Temp** in °C). If the temperature does not decrease below the defined limit within the next 5 minutes after the temperature was reached, the counter in question will be incremented by one and also locked for the next two hours. In the case the CIP would last longer than two hours the counter would be incremented by one once more.

Pressing the [ENTER] key will bring up the Save Changes dialog. Selecting No will discard the entered values, selecting Yes will make the entered values the current ones.

8.6.3 SIP Cycle Limit



Navigate to the menu "SIP Cycle Limit" by using the ▲ and ▼ keys and press [ENTER].



The SIP cycle limit counts the number of SIP cycles. If the limit (user defined) is reached, an alarm can be indicated and set to a certain output OC. The following options are possible:

SIP Max 000		Temp 115	
Alarm		R#	
		YES/NO	
		choose OC	

If the Max setting is on 000, the counter functionality is turned off. The alarm will be reset after exchanging the sensor. For oxygen sensors, the counter can be reset (see chapter 8.6.5 "Reset ISM Counter/Timer").

SIP characteristics: SIP Cycles will be automatically recognized by the sensor. Since SIP cycles will vary in intensity (duration and temperature) for each application the algorithm of the counter recognizes an increase of the measurement temperature above a adjustable limit (parameter **Temp** in °C). If the temperature does not decrease below the defined limit within the next 5 minutes after the first temperature was reached, the counter in question will be incremented by one and also locked for the next two hours. In the case the SIP would last longer than two hours the counter would be incremented by one once more.

Pressing the [ENTER] key will bring up the Save Changes dialog. Selecting No will discard the entered values, selecting Yes will make the entered values the current ones.

8.6.4 Autoclaving Cycle Limit



NOTE: The transmitter recognizes the connected ISM sensor and offers this menu only if an auto-clavable sensor is connected.

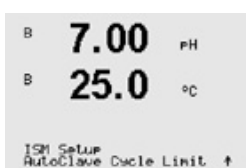

Navigate to the menu "AutoClave Cycle Limit" by using the ▲ and ▼ keys and press [ENTER].



The Autoclaving Cycle Limit counts the number of autoclaving cycles. If the limit (user defined) is reached, an alarm can be indicated and set to a certain output OC. The following options are possible:

SIP Max	000	YES/NO	R#	choose OC
Alarm				

If the Max setting is on 000, the counter functionality is turned off. The alarm will be reset after exchanging the sensor. For oxygen sensors, the counter can also be reset manually (see chapter 8.6.5 "Reset ISM Counter/Timer").

Autoclave characteristics: Since during the autoclaving cycle the sensor is not connected to the transmitter, you will be asked after every sensor connection, whether the sensor was autoclaved or not. According to your selection, the counter will be incremented or not.

Pressing the [ENTER] key will bring up the Save Changes dialog. Selecting No will discard the entered values, selecting Yes will make the entered values the current ones.

8.6.5 Reset ISM Counter/Timer

This menu allows resetting counter and timer functions which cannot be reseted automatically. The adaptive calibration timer will be reseted after a successful adjustment or calibration.



Navigate to the menu "Reset ISM Counter/Timer" by using the ▲ and ▼ keys and press [ENTER].



If an pH sensor or amperometric oxygen sensor is connected, the menu for resetting the Time To Maintenance is displayed. Time To Maintenance needs to be reset after the following operations.

pH sensors: manual maintenance cycle on the sensor.

oxygen sensor: manual maintenance cycle on the sensor or exchanging of the inner-body or membrane of the sensor

[Press ENTER]



If an oxygen sensor is connected, the menu for resetting the CIP and SIP counter is displayed. These counters should be reset after the following operations.

Amperometric sensor: exchanging of the inner-body of the sensor.

[Press ENTER]

8.6.6 DLI Stress Adjustment (Only for pH ISM Sensors)

Through this menu the calculation of the diagnostic data DLI, TTM and ACT can be adapted to application requirements and/or experience.



NOTE: The function is only available for pH ISM sensors with corresponding firmware versions.

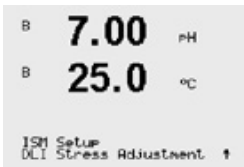

Navigate to the menu "DLI Stress Adjustment" by using the ▲ and ▼ keys and press [ENTER].

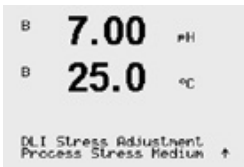

Adjust the Process Stress parameter based on the particular application and/or requirements

Low: DLI, TTM and ACT will be increased approximately 25 % compared with "Medium".

Medium: Default value, (equal DLI, TTM and ACT values based on former firmware versions of the transmitter).

High: DLI, TTM and ACT will be reduced approximately 25 % compared with "Medium".

Pressing the [ENTER] key will bring up the Save Changes dialog. Selecting No will discard the entered values, selecting Yes will make activate entered values.

8.7 Display

(PATH: Menu/Configure/Display)

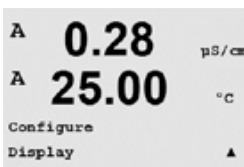

Enter configuration mode as described in Section 8.1 "Enter Configuration Mode".

This menu allows for the configuration of the values to be displayed and also the configuration of the display itself.

8.7.1 Measurement

The display has 4 lines. Line 1 on top and Line 4 on the bottom.

Select the values (Measurement a, b, c or d) to be displayed on each line of the display.

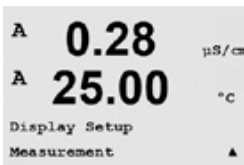

The selection of the values for a, b, c, d needs to be done under Configuration/Measurement/Channel Setup.

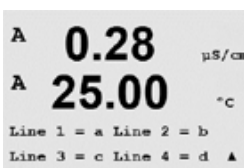

Select the "Error Display" mode. If this is set to "On" when an alarm or warning has occurred, the message "Failure – Press ENTER" will be displayed on Line 4 when an alarm occurs in the normal measurement mode.



Pressing the [ENTER] key again will bring up the Save Changes dialog. Selecting No will discard the entered values, selecting Yes will make the entered values the current ones.

8.7.2 Resolution



This menu allows the setting of the resolution of each displayed value.

The accuracy of the measurement is not effected by this setting.

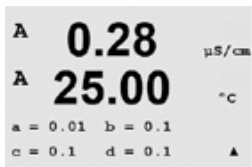

Possible settings are 1, 0.1, 0.01, 0.001 or Auto.

Pressing the [ENTER] key will bring up the Save Changes dialog.

8.7.3 Backlight



This Menu allows the setting of the back light options of the display.

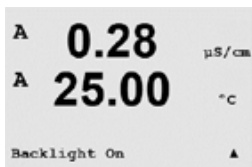

Possible settings are On, On 50 % or Auto Off 50 %. If Auto Off 50 % is selected then the backlight will go to 50 % after 4 minutes with no keypad activity. The backlight will automatically come back on if a key is pressed.

Pressing the [ENTER] key will bring up the Save Changes dialog.

8.7.4 Name



This menu allows for the configuration of an alpha-numeric name which is displayed in the first 9 characters on lines 3 and 4 of the display. The default is nothing (blank).

If a name is entered on line 3 and/or 4 a measurement can be still displayed on the same line.



Use the ◀ and ▶ keys to navigate between digits to be altered. Using the ▲ and ▼ keys to change the character to be displayed. Once all digits of both display channels have been entered, press [ENTER] to bring up the Save Changes dialog.



The resulting display in the measurement mode appears on lines 3 and 4 ahead of the measurements.

8.7.5 ISM Sensor Monitoring (Available When ISM Sensor Connected)

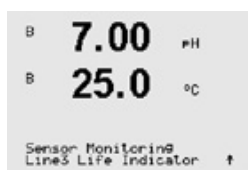

The sensor monitoring allows you to display the sensor monitoring details on line 3 and 4 in the display. The following options are possible:

Line 3 Off/Time Indicator/Time to Maint/Adapt Cal Timer
Line 4 Off/Time Indicator/Time to Maint/Adapt Cal Timer

8.8 Hold Analog Outputs

(PATH: Menu/Configure/Hold Outputs)



Enter configuration mode as described in Section 8.1 "Enter Configuration Mode".

The **"Hold outputs"** function applies during the calibration process. If set "Hold outputs" to Yes, during calibration process the analog output, the output OC will be at hold state. The hold state depends on the setting. For the possible hold settings, see the list below. The following options are possible:

Hold Outputs? Yes/No

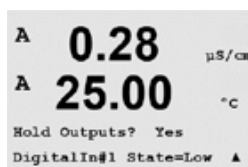

The **"DigitalIn"** function applies all the time. As soon as a signal is active on the digital input the transmitter goes to hold mode and the values on the analog output, the output OC will be at hold state.

DigitalIn1 / 2 State = Off/Low/High



NOTE: DigitalIn1 is to hold channel A (conventional sensor)
DigitalIn2 is to hold channel B (ISM sensor)

Possible Hold states:

Output OC:	On/Off	(Configuration/Set point)
Analog Output:	Last/Fixed	(Configuration/Analog output)
PID OC:	Last/Off	(PID setup/Mode)

9 System

(PATH: Menu/System)

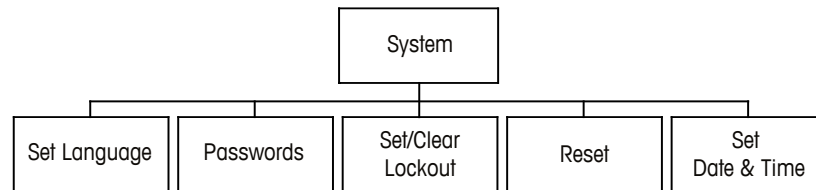

While in measurement mode press the ◀ key. Press the ▼ or ▲ key to navigate to “System” – Menu and press [ENTER].

9.1 Set Language

(PATH: Menu/System/Set Language)

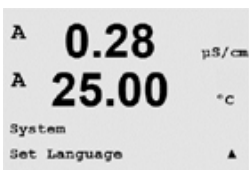

This menu allows the configuration of the display language.

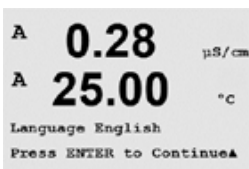

The following selections are possible:
English, French, German, Italian, Spanish, Portuguese, Russian or Japanese (Katakana).

Pressing the [ENTER] key will bring up the Save Changes dialog.

9.2 Passwords

(PATH: Menu/System/Passwords)

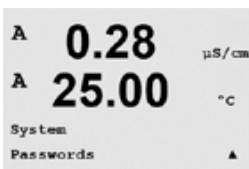

This menu allows for the configuration of operator and administrator passwords, as well as setting up a list of allowed menus for the operator. The administrator has rights to access all menus. All default passwords for new transmitters are “00000”.

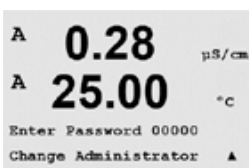

The passwords menu is protected: Enter the administrator password to enter the menu.

9.2.1 Changing Passwords

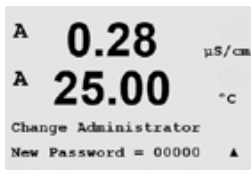

See Section 9.3 on how to enter the passwords menu. Select Change Administrator or Change Operator and set the new password.

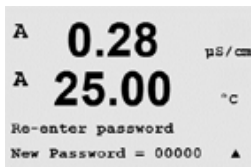

Press the [ENTER] key and confirm the new password. Press [ENTER] again to bring up the Save Changed dialog.

9.2.2 Configuring Menu Access for Operator

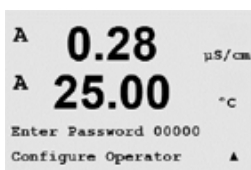

See 9.3 on how to enter the passwords Menu. Select Configure Operator to configure the access list for the operator. It is possible to assign/deny rights to the following menus: Cal Key, Quick Setup, Configuration, System, PID Setup and Service.



Choose either Yes or No to give/deny access to the above menus and press [ENTER] to advance to the next items. Pressing the [ENTER] key after configuring all menus will bring up the Save Changes dialog. Selecting No will discard the entered values, selecting Yes will make the entered values the current ones.

9.3 Set/Clear Lockout

(PATH: Menu/System/Set/Clear Lockout)

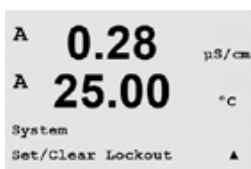

This menu enables/disables the lockout functionality of the transmitter. The user will be asked for a password before being allowed into any menus if the lockout functionality is enabled.

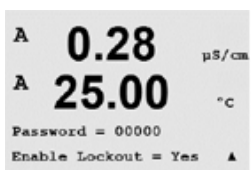

The lockout-menu is protected: Enter the administrator or operator password and select YES to enable or NO to disable the lockout functionality. Pressing the [ENTER] key after the selection will bring up the Save Changes dialog. Selecting No will discard the entered value, selecting Yes will make the entered value the current one.

9.4 Reset

(PATH: Menu/System/Reset)

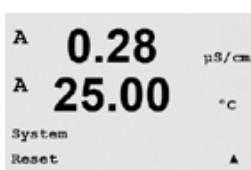

This menu allows access to the following options:

Reset System, Reset Meter Cal, Reset Analog Cal.

9.4.1 Reset System

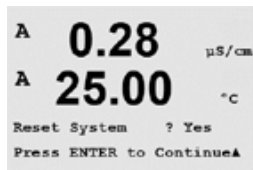

This menu allows the reset of the meter to the factory default settings (setpoints off, analog outputs off, etc.). The meter calibration and the analog output calibration are not affected.

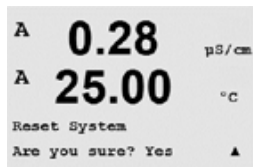

Pressing the [ENTER] key after the selection will bring up a confirmation screen. Selecting No will return the user to the measurement mode with no changes. Selecting Yes will reset the meter.

9.4.2 Reset Meter Calibration

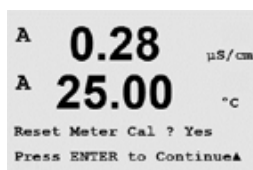

This menu allows the reset of the meter's calibration factors to the last factory calibration values.

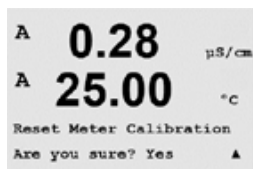

Pressing the [ENTER] key after the selection will bring up a confirmation screen. Selecting No will return the user to the measurement mode with no changes. Selecting Yes will reset the meter calibration factors.

9.4.3 Reset Analog Calibration

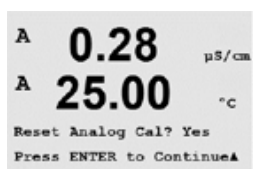

This menu allows reset of the analog output calibration factors to the last factory calibration values.

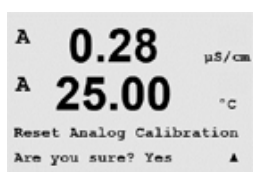

Pressing the [ENTER] key after the selection will bring up a confirmation screen. Selecting No will return the user to the measurement mode with no changes. Selecting Yes will reset the analog output calibration.

9.5 Set Date & Time



Please enter the actual date and time. The following options are possible. This function is automatically activated at every power-up.

Date (YY-MM-DD):

Time (HH:MM:SS):

10 PID Setup

(PATH: Menu/PID Setup)

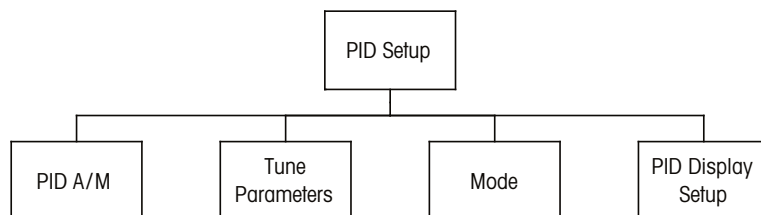

PID control is proportional, integral and derivative control action that can provide smooth regulation of a process. Before configuring the transmitter, the following process characteristics must be identified.

Identify the **control direction** of the process

- **Conductivity:**

- Dilution – direct acting where increasing measurement produces increasing control output such as controlling the feed of low conductivity diluting water to rinse tanks, cooling towers or boilers
- Concentrating – reverse acting where increasing measurement produces decreasing control output, such as controlling chemical feed to attain a desired concentration

- **Dissolved Oxygen:**

- Deaeration – direct acting where increasing DO concentration produces increasing control output such as controlling the feed of a reducing agent to remove oxygen from boiler feedwater
- Aeration – reverse acting where increasing DO concentration produces decreasing control output, such as controlling an aerator blower speed to maintain a desired DO concentration in fermentation or wastewater treatment

- **pH/ORP:**

- Acid feed only – direct acting where increasing pH produces increasing control output, also for ORP reducing reagent feed
- Base feed only – reverse acting where increasing pH produces decreasing control output, also for ORP oxidizing reagent feed
- Both acid and base feed – direct and reverse acting

Identify the **control output** type based on the control device to be used:

- Pulse frequency – used with pulse input metering pump
- Pulse length – used with solenoid valve
- Analog – used with current input device such as electric drive unit, analog input metering pump or current-to-pneumatic (I/P) converter for pneumatic control valve

Default control settings provide linear control, which is appropriate for conductivity, dissolved oxygen. Therefore, when configuring PID for these parameters (or simple pH control) ignore settings of deadband and corner points in the tuning parameter section below. The non-linear control settings are used for more difficult pH/ORP control situations.

If desired, identify the non-linearity of the pH/ORP process. Improved control can be obtained if the non-linearity is accommodated with an opposing non-linearity in the controller. A titration curve (graph of pH or ORP vs. reagent volume) made on a process sample provides the best information. There is often a very high process gain or sensitivity near the setpoint and decreasing gain further away from the setpoint. To counteract this, the instrument allows for adjustable non-linear control with settings of a deadband around the setpoint, corner points further out and proportional limits at the ends of control as shown in the figure below.

Determine the appropriate settings for each of these control parameters based on the shape of the pH process titration curve.

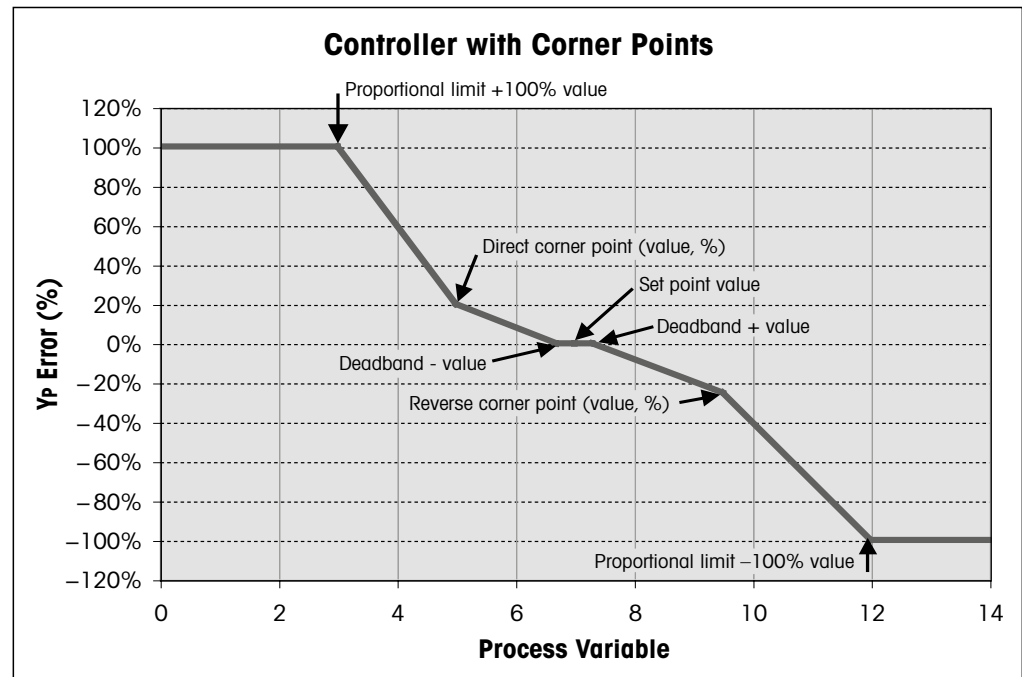

10.1 Enter PID Setup

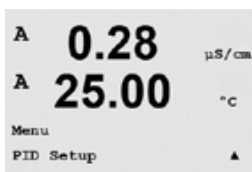

While in measurement mode press the ◀ key. Press the ▲ or ▼ key to navigate to the PID Set-up-menu and press [ENTER].

10.2 PID Auto/Manual

(PATH: MENU/PID Setup/PID A/M)



This menu allows selection of automatic or manual operation. Select Auto or Manual operation.

Pressing the [ENTER] key will bring up the Save Changes dialog.

10.3 Mode

(PATH: MENU/PID Setup/Mode)

This menu contains the selection of control modes using OCs.

Press [ENTER].



10.3.1 PID Mode

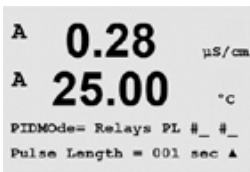

This menu assigns a OC or analog output for PID control action as well as details of their operation. Based on the control device being used, select one of the following three paragraphs for use with solenoid valve, pulse input metering pump or analog control.

Pulse Length – If using a solenoid valve, select “OC” and “PL”, pulse length. Choose the first OC position as #1 (recommended) and/or the second OC position as #2 (recommended) as well as the pulse length (PL) according to the table below. A longer pulse length will reduce wear on the solenoid valve. The % “on” time in the cycle is proportional to the control output.



NOTE: All OCs #1, #2 can be used for the controlling function.

	1 st OC	2 nd OC	Pulse OC
Conductivity	Controlling concentrating reagent feed	Controlling dilution water	Short (PL) provides more uniform feed. Suggested start point = 30 sec.
pH/ORP	Feeding base	Feeding acid	Reagent addition cycle: short PL provides more uniform addition of reagent. Suggested start point = 10 sec.
Dissolved Oxygen	Reverse control action	Direct acting control action	Feed cycle time: short PL provides more uniform feed. Suggested start point = 30 sec.

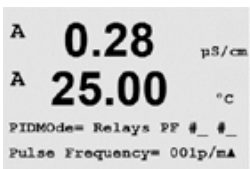

Pulse Frequency – If using a pulse input metering pump, select “OC” and “PF”, pulse frequency. Choose the first OC position as #1 and/or the second OC position as #2 according to the table below. Set the pulse frequency to the maximum frequency allowed for the particular pump being used, typically 60 to 100 pulses/minute. Control action will produce this frequency at 100 % output.



NOTE: All OCs #1, #2 can be used for the controlling function.



CAUTION: Setting the pulse frequency too high may cause the pump to overheat.

	1 st OC	2 nd OC	Pulse Frequency (PF)
Conductivity	Controlling concentrating chemical feed	Controlling dilution water	Max allowed for the pump used (typically 60–100 pulses/minute)
pH/ORP	Feeding base	Feeding acid	Max allowed for the pump used (typically 60–100 pulses/minute)
Dissolved Oxygen	Reverse control action	Direct acting control action	Max allowed for the pump used (typically 60–100 pulses/minute)

10.4 Tune Parameters

(PATH: MENU/PID Setup/Tune Parameters)



This menu assigns control to a measurement and sets the setpoint, tuning parameters and non-linear functions of the controller through a series of screens.

10.4.1 PID Assignment & Tuning

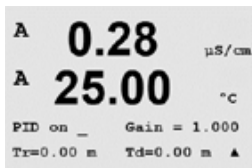

Assign the measurement, a, b, c, or d to be controlled after "PID on_". Set the Gain (unitless), integral or reset time Tr (minutes) and rate or derivative time Td (minutes) needed for control. Press [ENTER]. Gain, reset and rate are later adjusted by trial and error based on process response. Always begin with Td at zero.

10.4.2 Setpoint & Deadband



Enter the desired setpoint value and the deadband around the setpoint, where no proportional control action will take place. Be sure to include the units multiplier u or m for conductivity. Press [ENTER].

10.4.3 Proportional Limits



Enter the low and high proportional limits – the range over which control action is required. Be sure to include the units multiplier u or m for conductivity. Press [ENTER].

10.4.4 Corner Points

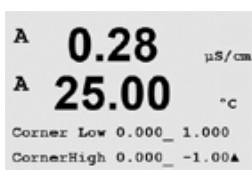

Enter the low and high corner points in conductivity, pH, dissolved oxygen units and the respective output values from -1 to +1, shown in the figure as -100 to +100%. Press [ENTER].

10.5 PID Display

(PATH: Menu/PID Setup/PID Display Setup)

This screen enables display of PID control status in the normal measurement mode.



When PID Display is selected, the status (Man or Auto) and control output (%) will be displayed on the bottom line. If controlling pH, the reagent will also be displayed. In addition, for the display to be enabled, a measurement must be assigned under Tune Parameters and a OC or analog output must be assigned under Mode.



In manual, the control output may be adjusted with the up and down arrow keys. (The "Info" key function is not available in manual.)



11 Service

(PATH: Menu/Service)

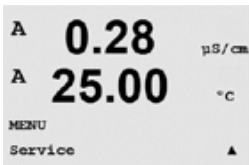
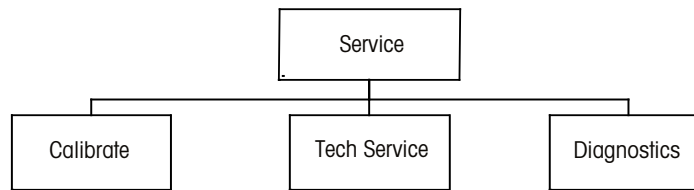

While in measurement mode press the ◀ key. Press the ▲ or ▼ key to navigate to the “Service” menu and press [ENTER]. The available system configuration options are detailed below.

11.1 Diagnostics

(PATH: Menu/Service/Diagnostics)



This menu is a valuable tool for troubleshooting and provides diagnostic functionality for the following items: Model/Software Revision, Digital Input, Keypad, Memory, Set OC, Read OC, Set Analog Outputs, Read Analog Outputs.

11.1.1 Model/Software Revision

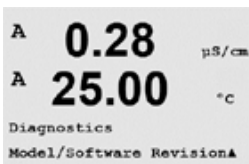

Essential information for every Service call is the model and software revision number. This menu shows the part number, model and the serial number of the transmitter. By using the ▼ key it is possible to navigate forward through this menu and get additional information like the current version of firmware implemented on the transmitter: (Master V_XXXX and Comm V_XXXX); and – if an ISM sensor is connected – the version of the sensor firmware (Sensor FW V_XXX) and sensor hardware (Sensor HW XXXX).

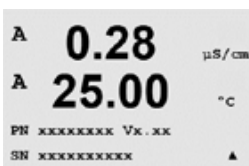

Press [ENTER] to exit from this display.

11.1.2 Digital Input



The digital input menu shows the state of the digital inputs. Press [ENTER] to exit from this display.



11.1.3 Display

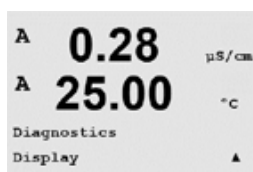

All pixels of the display will be lit for 15 seconds to allow troubleshooting of the display. After 15 seconds the transmitter will return to the normal measuring mode or press [ENTER] to exit sooner.

11.1.4 Keypad



For keypad diagnostics, the display will indicate which key is pressed. Pressing [ENTER] will return the transmitter to the normal measuring mode.

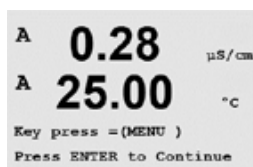

11.1.5 Memory

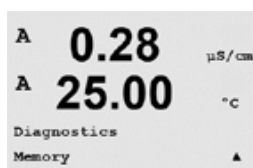

If Memory is selected then the transmitter will perform a RAM and ROM memory test. Test patterns will be written to and read from all RAM memory locations. The ROM checksum will be recalculated and compared to the value stored in the ROM.

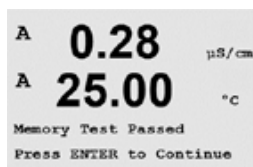

11.1.6 Set OC

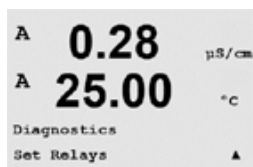

The Set OC diagnostic menu allows to open or close each OC manually. To access OC and 6, press [ENTER].

0 = open the OC
1 = close the OC

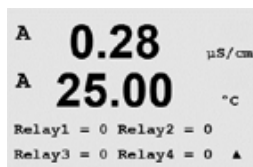

Press [ENTER] to return to Measurement mode.

11.1.7 Read OC



The Read OC diagnostic menu shows the state of each OC as defined below.
To display OC 5 and 6, press [ENTER]. Press [ENTER] again to exit from this display.

0 = Normal
1 = Inverted.

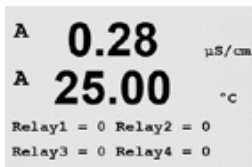

11.1.8 Set Analog Outputs



This menu enables the user to set all analog outputs to any mA value within the 0–22 mA range.
Press [ENTER] to exit from this display.

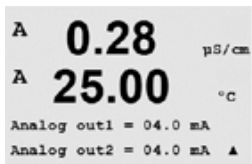

11.1.9 Read Analog Outputs

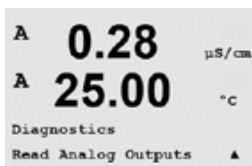

This menu shows the mA value of the analog outputs.

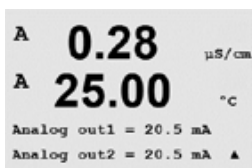

Press [ENTER] to exit from this display.

11.2 Calibrate

(PATH: Menu/Service/Calibrate)

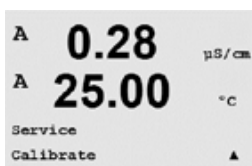

Enter Service Menu as described in section 11 “Enter Service Menu”, select Calibrate, and press [ENTER].

This menu has the options to calibrate the transmitter and the analog outputs and also allows the unlocking of calibration functionality

11.2.1 Calibrate Meter (Only for Channel A)

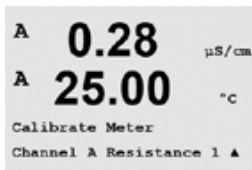

The M400 transmitter is factory calibrated within specifications. It is not necessary to perform meter re-calibration unless extreme conditions cause an out of spec operation shown by Calibration Verification. Periodic verification/re-calibration may also be necessary to meet Q.A. requirements. Meter calibration can be selected as current (used for most dissolved oxygen, Voltage, Rg Diagnostic, Rr Diagnostic (used for pH), and temperature (used for all measurements).

11.2.1.1 Temperature

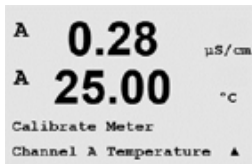

Temperature is performed as a three point calibration. The table above shows the resistance values of these three points.

Navigate to the Calibrate Meter screen and choose Temperature calibration for Channel A.

Press [ENTER] to begin temperature calibration process

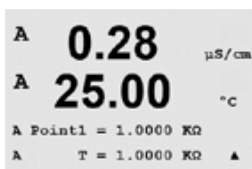

The first text line will ask for the Point 1 temperature resistance value (this will correspond to temperature 1 value shown on the calibration module accessory). The second text line will show the measured resistance value. When the value stabilizes, press [ENTER] to perform calibration.

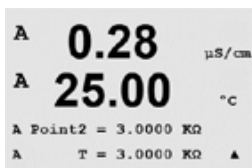

The transmitter screen will then prompt the user to enter the value for Point 2, and T2 will display the measured resistance value. When this value stabilizes, press [ENTER] to calibrate this range.

Repeat these steps for Point 3.

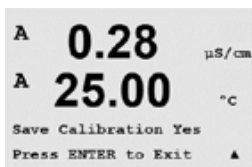

Press [ENTER] to bring up a confirmation screen. Select Yes to save the calibration values and the successful calibration is confirmed on the display.

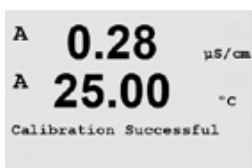

The transmitter will return to the measurement mode in approximately 5 seconds.

11.2.1.2 Current

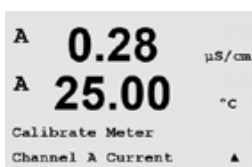

Current calibration is performed as a two point calibration.

Navigate to the Calibrate Meter screen and select Channel A.

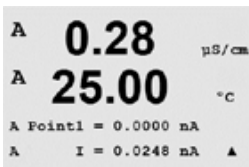

Enter the value for Point 1, in milliamps, of the current source connected to the input. The second display line will show the measured current. Press [ENTER] to begin the calibration process.

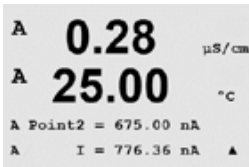

Enter the value for Point 2, in milliamps, of the current source connected to the input. The second display line shows the measured current.

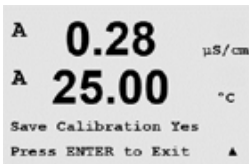

Pressing the [ENTER] key after entering Point 2 will bring up a confirmation screen. Select Yes to save the calibration values and the successful calibration is confirmed on the display. The transmitter will return to the measurement mode in approximately 5 seconds.

11.2.1.3 Voltage

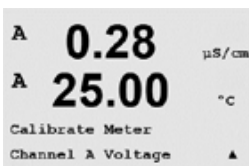

Voltage calibration is performed as a two point calibration.

Navigate to the Calibrate Meter screen and select Channel A and Voltage.

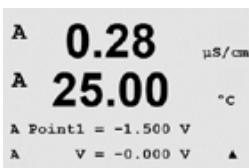

Enter the value for Point 1 in, volts, connected to the input. The second display line will show the measured voltage. Press [ENTER] to begin the calibration process.

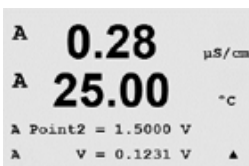

Enter the value for Point 2, in volts, of the source connected to the input. The second display line shows the measured voltage.

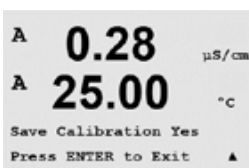

Pressing the [ENTER] key after entering Point 2 will bring up a confirmation screen. Select Yes to save the calibration values and the successful Calibration is confirmed on the display. The transmitter will return to the measurement mode in approximately 5 seconds.

11.2.1.4 Rg Diagnostic

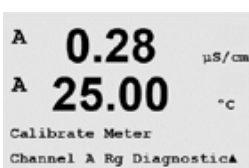

Rg diagnostic is performed as a two point calibration. Navigate to the Calibrate Meter screen and select Channel A and Rg Diagnostic.

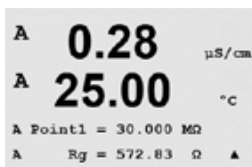

Enter the value for Point 1 of the calibration according to the resistor connected across the pH glass electrode measuring input. Press [ENTER] to begin the calibration process.

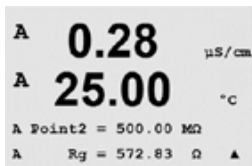

Enter the value for Point 2 of the calibration according to the resistor connected across the pH glass electrode measuring input.

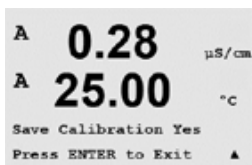

Pressing the [ENTER] key after entering Point 2 will bring up a confirmation screen. Select Yes to save the calibration values and the successful calibration is confirmed on the display. The transmitter will return to the measurement mode in approximately 5 seconds.

11.2.1.5 Rr Diagnostic

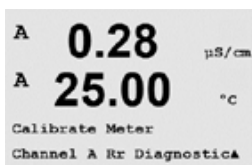

Rr diagnostic is performed as a two point calibration. Navigate to the Calibrate Meter screen and select Channel A and Rr Diagnostic.

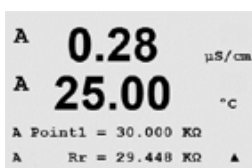

Enter the value for Point 1 of the calibration according to the resistor connected across the pH reference measuring input. Press [ENTER] to begin the calibration process.

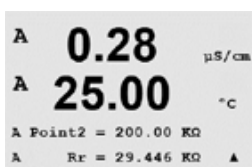

Enter the value for Point 2 of the calibration according to the resistor connected across the pH reference measuring input.

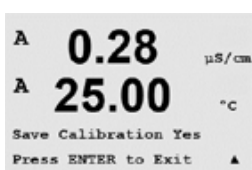

Pressing the [ENTER] key after entering Point 2 will bring up a confirmation screen. Select Yes to save the calibration values and the successful calibration is confirmed on the display. The transmitter will return to the measurement mode in approximately 5 seconds.

11.2.1.6 Calibrate Analog Output Signals

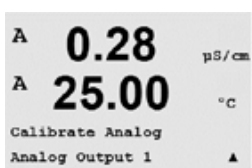

Select the Analog Output you wish to calibrate. Each analog output can be calibrated at 4 and 20 mA.

```

A 0.28  μS/cm
A 25.00  °C
Aout1 20mA Set 45000
Press ENTER when Done ▲

```

Connect an accurate milliamp meter to the analog output terminals and then adjust the five digit number in the display until the milliamp meter reads 4.00 mA and repeat for 20.00 mA.

```

A 0.28  μS/cm
A 25.00  °C
Aout1 4mA Set 08800
Press ENTER when Done ▲

```

As the five digit number is increased the output current increases and as the number is decreased the output current decreases. Thus coarse changes in the output current can be made by changing the thousands or hundreds digits and fine changes can be made by changing the tens or ones digits.

```

A 0.28  μS/cm
A 25.00  °C
Save Calibration Yes
Press ENTER to Exit ▲

```

Pressing the [ENTER] key after entering both values will bring up a confirmation screen. Selecting No will discard the entered values, selecting Yes will make the entered values the current ones.

11.2.2 Calibrate Unlock

```

A 0.28  μS/cm
A 25.00  °C
Calibrate Unlock

```

Select this Menu to configure the CAL Menu, see Section 7.

```

A 0.28  μS/cm
A 25.00  °C
Unlock Calibration Yes
Press ENTER to Continue▲

```

Selecting Yes means that meter and analog output calibration menus will be selectable under the CAL Menu. Selecting No means that only the sensor calibration is available under the CAL Menu. Press [ENTER] after the selection to display a confirmation screen.

11.3 Tech Service

(PATH: Menu/Tech Service)



NOTE: This menu is for METTLER TOLEDO service personnel use only.

12 Info

(PATH: Info)

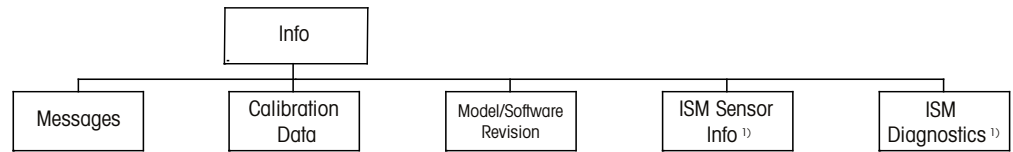

1) Only available in combination with ISM sensors

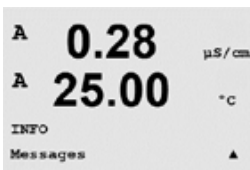

Pressing the ▼ key will display the Info menu with the options Messages, Calibration Data and Model/Software Revision.

12.1 Messages

(PATH: Info/ Messages)

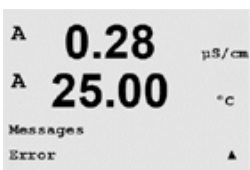

The most recent message is displayed. The up and down arrow keys allow scrolling through the last four messages that have occurred.



Clear Messages clears all the messages. Messages are added to the message list when the condition that generates the message first occurs. If all messages are cleared and a message condition still exists and started before the clear then it will not appear in the list. For this message to re-occur in the list the condition must go away and then reappear.

Press [ENTER] to exit from this display.

12.2 Calibration Data

(PATH: Info/ Calibration Data)

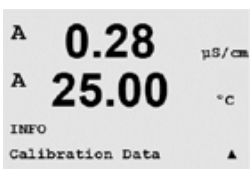

Selecting Calibration Data displays the calibration constants for each sensor.



P = calibration constants for the primary measurement
S = calibration constants for the secondary measurement

Press ▼ for ORP calibration data of ISM pH sensors.

Press [ENTER] to exit from this display.

12.3 Model/Software Revision

(PATH: Info/Model/Software Revision)



Selecting Model/Software Revision will display the part number, model and the serial number of the transmitter.

By using the ▼ key it is possible to navigate forward through this menu and get additional information like the current version of firmware implemented on the transmitter (Master V_XXXX and Comm V_XXXX) and – if an ISM sensor is connected – the version of the sensor firmware (Sensor FW V_XXX) and sensor hardware (Sensor HW XXXX).

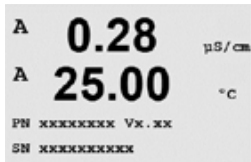

The displayed information is important for any Service call. Press [ENTER] to exit from this display.

12.4 ISM Sensor Info (Available When ISM Sensor Connected)

(PATH: Info/ISM Sensor Info)

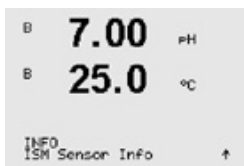

After plugging in an ISM sensor it is possible by using the key A or ▼ to navigate to the Menu "ISM Sensor Info".

Press [ENTER] to select the menu.

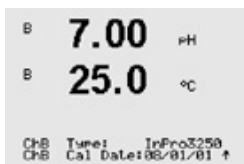

The following information about the sensor will be shown in this menu. Use up and down arrows to scroll in the menu. Type: Type of sensor (e.g. InPro 3250)

Cal Date: Date of the last adjustment

Serial-No.: Serial number of the connected sensor

Part-No.: Part number of the connected sensor

Press [ENTER] to exit from this display.

12.5 ISM Sensor Diagnostics (Available When ISM Sensor Connected)

(PATH: Info/ISM Diagnostics)



After plugging in an ISM sensor it is possible by using the key A or ▼ to navigate to the Menu "ISM Diagnostics".

Press [ENTER] to select the menu.

Navigate to one of the menus, described in this section, and press [ENTER] again.



Cal History

The calibration history is stored with a time stamp in the ISM sensor and is displayed on the transmitter. The calibration history offers the following information:

Fact (Factory calibration): This is the original dataset, determined in the factory. This dataset remains stored in the sensor for reference and cannot be overwritten.

Act (Actual adjustment): This is the actual calibration dataset which is used for the measurement. This dataset moves to Cal2 position after the next adjustment.

1. Adj (First adjustment): This is the first adjustment after the factory calibration. This dataset remains stored in the sensor for reference and cannot be overwritten

Cal1 (last calibration/adjustment): This is the last executed calibration/adjustment. This dataset moves to Cal2 and then to Cal3 when a new calibration/adjustment is performed. Afterwards, the dataset is not available anymore.

Cal2 and Cal3 acting in the same way as Cal1.

Definition:

Adjustment: The calibration procedure is completed and the calibration values are taken over and used for the measurement (Act) and stated in Cal1. The current values from Act will move to Cal2.

Calibration: The calibration procedure is completed, but the calibration values will not be over-taken and the measurement continuous with the last valid adjustment dataset (Act). The dataset will be stored under Cal1.

The calibration history is used for the estimation of the lifetime indicator for ISM sensors.

Press [ENTER] to exit from this display.



NOTE: This function requires the correct setting of date and time during calibration and/or adjustment tasks (see chapter 9.5 "Set Date & Time").

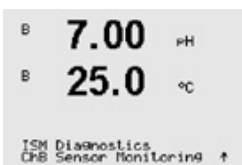

Sensor monitoring (not available for Cond 4-e sensor)

The sensor monitoring shows the different diagnostics functions available for each ISM sensor. The following information is available:



Lifetime Indicator: Shows an estimation of the remaining lifetime to ensure a reliable measurement. The lifetime is indicated in days (d) and percentage (%). For a description of the Lifetime indicator, please see section 8.6 "ISM Setup". For oxygen sensors, the lifetime indicator is related to the inner-body of the sensor. If you want to bring the bar indicator on the screen, see chapter 8.7.5 "ISM Sensor Monitoring (Available When ISM Sensor Connected)" to activate ISM functions.



Adaptive Cal Timer: This timer shows a Adaptive Cal Timer, when the next calibration should be performed to keep the best possible measurement performance. The Adaptive Cal Timer is indicated in days (d) and percentage (%). For a description of the Adaptive Cal Timer, please see section 8.6 "ISM Setup".



Time to Maintenance: This timer shows a Time to Maintenance, when the next cleaning cycle should be performed to keep the best possible measurement performance. The Time to Maintenance is indicated in days (d) and percentage (%). For a description of the Time to Maintenance, please see section 8.6 "ISM Setup". For oxygen sensors, the Time to Maintenance indicates a maintenance cycle for the membrane and electrolyte.

Press [ENTER] to exit from this display.

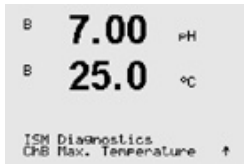

Max. Temperature

The maximum temperature shows the maximum temperature that this sensor has ever seen, together with a time stamp of this maximum. This value is stored on the sensor and cannot be changed. During autoclaving the Max temperature is not recorded.

Max. Temperature | XXX°CYY/MM/DD
Tmax

Press [ENTER] to exit from this display.



NOTE: This function requires the correct setting of date and time of the transmitter, (see chapter 9.5 "Set Date & Time")



CIP Cycles

Shows the amount of CIP cycles that the sensor has been exposed to. For a description of the CIP Cycle indicator, please see section 8.6 "ISM Setup"

CIP Cycles xxx of xxx

Press [ENTER] to exit from this display.



SIP Cycles

Shows the amount of SIP cycles that the sensor has been exposed to. For a description of the SIP Cycle indicator, please see section 8.6 "ISM Setup"

SIP Cycles xxx of xxx

Press [ENTER] to exit from this display.



Autoclaving Cycles

Shows the amount of Autoclaving cycles that the sensor has been exposed to. For a description of the AutoClave Cycle indicator, please see section 8.6 "ISM Setup"

Autoclaving Cycles xxx of xxx

Press [ENTER] to exit from this display.

13 Maintenance

13.1 Front Panel Cleaning

Clean the front panel with a damp soft cloth (water only, no solvents). Gently wipe the surface and dry with a soft cloth.

14 Troubleshooting

If the equipment is used in a manner not specified by METTLER TOLEDO the protection provided by the equipment may be impaired. Review the table below for possible causes of common problems:

Problem	Possible Cause
Display is blank.	<ul style="list-style-type: none"> • No power to M400. • LC display contrast set incorrectly. • Hardware failure.
Incorrect measurement readings.	<ul style="list-style-type: none"> • Sensor improperly installed. • Incorrect units multiplier entered. • Temperature compensation incorrectly set or disabled. • Sensor or transmitter needs calibration. • Sensor or patch cord defective or exceeds recommended maximum length. • Hardware failure.
Measurement readings not stable.	<ul style="list-style-type: none"> • Sensors or cables installed too close to equipment that generates high level of electrical noise. • Recommended cable length exceeded. • Averaging set too low. • Sensor or patch cord defective.
Displayed  is flashing.	<ul style="list-style-type: none"> • Setpoint is in alarm condition (setpoint exceeded). • Alarm has been selected (see chapter 8.5.1 "Alarm") and occurred.
Cannot change menu settings.	<ul style="list-style-type: none"> • User locked out for security reasons.

14.1 Cond (Resistive) Error Messages/Warning- and Alarm List for Analog Sensors

Alarms	Description
Watchdog time-out ¹⁾	SW/System fault
Cond Cell open ¹⁾	Cell running dry (no measurement solution) or wires are broken
Cond Cell shorted ¹⁾	Short circuit caused by sensor or cable

1) According to the parameterization of the transmitter (see chapter 8.5.1 "Alarm";
PATH: Menu/Configure/Alarm/Clean/Setup Alarm)

14.2 Cond (Resistive) Error Messages/Warning- and Alarm List for ISM Sensors

Alarms	Description
Watchdog time-out ¹⁾	SW/System fault
Dry Cond sensor ¹⁾	Cell running dry (no measurement solution)
Cell deviation ¹⁾	Multiplier out of tolerance ²⁾ (depends on sensor model).

1) According to the parameterization of the transmitter (see chapter 8.5.1 "Alarm";
PATH: Menu/Configure/Alarm/Clean/Setup Alarm).

2) For further information refer to the sensor documentation.

14.3 pH Error Messages/Warning- and Alarm List

14.3.1 pH Sensors Except Dual Membrane pH Electrodes

Warnings	Description
Warning pH slope >102 %	Slope too big
Warning pH Slope <90 %	Slope too small
Warning pH Zero ± 0.5 pH	Out of range
Warning pHGs change <0.3 ²⁾	Glass electrode resistance changed by more than factor 0.3
Warning pHGs change >3 ²⁾	Glass electrode resistance changed by more than factor 3
Warning pHRef change <0.3 ²⁾	Reference electrode resistance changed by more than factor 0.3
Warning pHRef change >3 ²⁾	Reference electrode resistance changed by more than factor 3

Alarms	Description
Watchdog time-out ¹⁾	SW/System fault
Error pH Slope >103 %	Slope too big
Error pH Slope <80 %	Slope too small
Error pH Zero ± 1.0 pH	Out of range
Error pH Ref Res >150 K Ω ²⁾	Reference electrode resistance too big (break)
Error pH Ref Res <2000 Ω ²⁾	Reference electrode resistance too small (short)
Error pH Gls Res >2000 M Ω ²⁾	Glass electrode resistance too big (break)
Error pH Gls Res <5 M Ω ²⁾	Glass electrode resistance too small (short)

1) ISM sensors only.

2) According to the parameterization of the transmitter (see chapter 8.5.1 "Alarm";
PATH: Menu/Configure/Alarm/Clean/Setup Alarm).

14.3.2 Dual Membrane pH Electrodes (pH/pNa)

Warnings	Description
Warning pH slope >102 %	Slope too big
Warning pH Slope < 90 %	Slope too small
Warning pH Zero ± 0.5 pH	Out of range
Warning pHGs change < 0.3 ¹⁾	Glass electrode resistance changed by more than factor 0.3
Warning pHGs change > 3 ¹⁾	Glass electrode resistance changed by more than factor 3
Warning pNaGs change < 0.3 ¹⁾	Glass electrode resistance changed by more than factor 0.3
Warning pNaGs change > 3 ¹⁾	Reference electrode resistance changed by more than factor 3

Alarms	Description
Watchdog time-out	SW/System fault
Error pH Slope >103 %	Slope too big
Error pH Slope < 80 %	Slope too small
Error pH Zero ± 1.0 pH	Out of range
Error pNa Gls Res > 2,000 M Ω ¹⁾	Glass electrode resistance too big (break)
Error pNa Gls Res < 5 M Ω ¹⁾	Glass electrode resistance too small (short)
Error pH Gls Res > 2,000 M Ω ¹⁾	Glass electrode resistance too big (break)
Error pH Gls Res < 5 M Ω ¹⁾	Glass electrode resistance too small (short)

1) According to the parameterization of the transmitter (see chapter 8.5.1 "Alarm";
PATH: Menu/Configure/Alarm/Clean/Setup Alarm).

14.3.3 ORP Messages

Warnings ¹⁾	Description
Warning ORP ZeroPt > 30 mV	Zero offset too big
Warning ORP ZeroPt < - 30 mV	Zero offset too small

Alarms ¹⁾	Description
Watchdog time-out	SW/System fault
Error ORP ZeroPt > 60 mV	Zero offset too big
Error ORP ZeroPt < - 60 mV	Zero offset too small

1) ISM sensors only.

14.4 Amperometric O₂ Error Messages/Warning- and Alarm List

14.4.1 High Level Oxygen Sensors

Warnings	Description
Warning O ₂ Slope < -90 nA	Slope too big
Warning O ₂ Slope > -35 nA	Slope too small
Warning O ₂ ZeroPt > 0.3 nA	Zero offset too big
Warning O ₂ ZeroPt < -0.3 nA	Zero offset too small

Alarms	Description
Watchdog time-out ¹⁾	SW/System fault
Error O ₂ Slope < -110 nA	Slope too big
Error O ₂ Slope > -30 nA	Slope too small
Error O ₂ ZeroPt > 0.6 nA	Zero offset too big
Error O ₂ ZeroPt < -0.6 nA	Zero offset too small
Electrolyte Low ¹⁾	Too low level of electrolyte

1) ISM sensors only.

14.4.2 Low Level Oxygen Sensors

Warnings	Description
Warning O ₂ Slope < -460 nA	Slope too big
Warning O ₂ Slope > -250 nA	Slope too small
Warning O ₂ ZeroPt > 0.5 nA	Zero offset too big
Warning O ₂ ZeroPt < -0.5 nA	Zero offset too small

Alarms	Description
Watchdog time-out ¹⁾	SW/System fault
Error Install O ₂ Jumper	In case of using InPro 6900 a jumper has to be installed (see chapter: Connection of Sensor – Dissolved Oxygen)
Error O ₂ Slope < -525 nA	Slope too big
Error O ₂ Slope > -220 nA	Slope too small
Error O ₂ ZeroPt > 1.0 nA	Zero offset too big
Error O ₂ ZeroPt < -1.0 nA	Zero offset too small
Electrolyte Low ¹⁾	Too low level of electrolyte

1) ISM sensors only.

14.4.3 Trace Oxygen Sensors

Warnings	Description
Warning O ₂ Slope < -5,000 nA	Slope too big
Warning O ₂ Slope > -3,000 nA	Slope too small
Warning O ₂ ZeroPt > 0.5 nA	Zero offset too big
Warning O ₂ ZeroPt < -0.5 nA	Zero offset too small

Alarms	Description
Watchdog time-out	SW/System fault
Error O ₂ Slope < -6,000 nA	Slope too big
Error O ₂ Slope > -2,000 nA	Slope too small
Error O ₂ ZeroPt > 1.0 nA	Zero offset too big
Error O ₂ ZeroPt < -1.0 nA	Zero offset too small
Electrolyte Low ¹⁾	Too low level of electrolyte

1) ISM sensors only.

14.5 Optical O₂ Error Messages/Warning- and Alarm List

Warnings	Description
Chx Cal Required ¹⁾	ACT = 0 or measured values out of range
Chx CIP Counter Expired	Limit of CIP cycles reached
Chx SIP Counter Expired	Limit of SIP cycles reached
Chx Autocl. Count. Exp.	Limit of autoclaving cycles reached

1) If this warning is displayed, you will find more information about the cause for the warning in Menu/Service/Diagnostics/O₂ optical.

Alarms	Description
Watchdog time-out	SW/System fault
Chx Signal error ²⁾	Signal or value for temperature out of range
Chx Shaft error ²⁾	Temperature bad or stray light too high (e.g. because a glass is fiber broken) or shaft has been removed
Chx Hardware error ²⁾	Electronic components fail

2) According to the parameterization of the transmitter (see section 8.5.1 "Alarm"; PATH: Menu/Configure/Alarm/Clean/Setup Alarm).

If an alarm has occurred, you will find more information about the cause for the alarm in Menu/Service/Diagnostics/O₂ optical.

14.6 Dissolved Carbon Dioxide Error Messages/Warning- and Alarm List

Warnings	Description
Warning pH slope >102 %	Slope too big
Warning pH Slope < 90 %	Slope too small
Warning pH Zero ± 0.5 pH	Out of range
Warning pH Zero <6.5 pH	Zero offset too small
Warning pH Gls change <0.3 ¹⁾	Glass electrode resistance changed by more than factor 0.3
Warning pH Gls change >3 ¹⁾	Glass electrode resistance changed by more than factor 3

Alarms	Description
Watchdog time-out ¹⁾	SW/System fault
Error pH Slope >103 %	Slope too big
Error pH Slope < 80 %	Slope too small
Error pH Zero ± 0.5 pH	Out of range
Error pH Gls Res > 2,000 M Ω ¹⁾	Glass electrode resistance too big (break)
Error pH Gls Res < 5 M Ω ¹⁾	Glass electrode resistance too small (short)

1) According to the parameterization of the transmitter (see section 8.5.1 "Alarm";
PATH: Menu/Configure/Alarm/Clean/Setup Alarm).

14.7 Warning- and Alarm Indication on the Display

14.7.1 Warning Indication

If there are conditions, which generate a warning, the message will be recorded and can be selected through the menu Messages (PATH: Info/Messages; see also chapter 12.1 "Messages"). According to the configuration of the transmitter the hint "Failure – Press ENTER" will be shown at line 4 of the display, if a warning or alarm has occurred (see also chapter 8.7 "Display"; PATH: Menu/Configure/Display/Measurement).

14.7.2 Alarm Indication

Alarms will be shown in the display by a flashing symbol  and recorded through the menu point Messages (PATH: Info/Messages; see also chapter 12.1 "Messages").

Furthermore the detection of some alarms can be activated or deactivated (see chapter 8.5 "Alarm/Clean"; PATH: Menu/Configure/Alarm/Clean) for an indication on the display. If one of these alarms occurs and the detection has been activated, the flashing symbol  will be shown on the display and the message will be recorded through the menu Messages (see chapter 12.1 "Messages"; PATH: Info/Messages).

Alarms which are caused by a violation of the limitation of a setpoint or the range (see chapter 8.4 "Set Points"; PATH: Menu/Configure/Setpoint) will also be shown by a flashing symbol  and recorded through the menu Messages (PATH: Info/Messages; see also chapter 12.1 "Messages").

According to the parameterisation of the transmitter the hint "Failure – Press ENTER" will be shown at line 4 of the display, if a warning or alarm has occurred (see also chapter 8.7 "Display"; PATH: Menu/Configure/Display/Measurement).

15 Accessories and Spare Parts

Please contact your local METTLER TOLEDO sales office or representative for details for Additional accessories and spare parts.

Description	Order no.
Pipe Mount Kit for ½ DIN models	30 300 480
Panel Mount Kit for ½ DIN models	52 500 213
Protective Hood for ½ DIN models	30 073 328

16 Specifications

16.1 General Specifications

Conductivity 2-e/4-e

Measurement parameters	Conductivity/resistivity and temperature
Conductivity ranges 2-electrode sensor	0.02 to 2,000 $\mu\text{S}/\text{cm}$ (500 $\Omega \times \text{cm}$ to 50 $\text{M}\Omega \times \text{cm}$)
	C = 0.01 0.002 to 200 $\mu\text{S}/\text{cm}$ (5,000 $\Omega \times \text{cm}$ to 500 $\text{M}\Omega \times \text{cm}$)
	C = 0.1 0.02 to 2,000 $\mu\text{S}/\text{cm}$ (500 $\Omega \times \text{cm}$ to 50 $\text{M}\Omega \times \text{cm}$)
	C = 1 15 to 4,000 $\mu\text{S}/\text{cm}$
	C = 3 15 to 12,000 $\mu\text{S}/\text{cm}$
	C = 10 10 to 40,000 $\mu\text{S}/\text{cm}$ (25 $\Omega \times \text{cm}$ to 100 $\text{k}\Omega \times \text{cm}$)
Conductivity ranges 4-electrode sensor	0.01 to 650 mS/cm (1.54 $\Omega \times \text{cm}$ to 0.1 $\text{M}\Omega \times \text{cm}$)
Display range for 2-e sensor	0 to 40,000 mS/cm (25 $\Omega \times \text{cm}$ to 100 $\text{M}\Omega \times \text{cm}$)
Display range for 4-e sensor	0.01 to 650 mS/cm (1.54 $\Omega \times \text{cm}$ to 0.1 $\text{M}\Omega \times \text{cm}$)
Chemical concentration curves	<ul style="list-style-type: none"> • NaCl: 0–26 % @ 0 °C to 0–28 % @ +100 °C • NaOH: 0–12 % @ 0 °C to 0–16 % @ +40 °C to 0–6 % @ +100 °C • HCl: 0–18 % @ –20 °C to 0–18 % @ 0 °C to 0–5 % @ +50 °C • HNO₃: 0–30 % @ –20 °C to 0–30 % @ 0 °C to 0–8 % @ +50 °C • H₂SO₄: 0–26 % @ –12 °C to 0–26 % @ +5 °C to 0–9 % @ +100 °C • H₃PO₄: 0–35 % @ +5 °C to +80 °C • User-defined concentration table (5 x 5 matrix)
TDS ranges	NaCl, CaCO ₃
Cond/Res accuracy ¹⁾	Analog: $\pm 0.5\%$ of reading or 0.25 Ω , whichever is greater, up to 10 $\text{M}\Omega\text{-cm}$
Cond/Res repeatability ¹⁾	Analog: $\pm 0.25\%$ of reading or 0.25 Ω , whichever is greater
Cond/Res resolution	Auto/0.001/0.01/0.1/1 (can be selected)
Temperature input	Pt1000/Pt100/NTC22K
Temperature measuring range	–40 to +200 °C (–40 to +392 °F)
Temperature resolution	Auto/0.001/0.01/0.1/1 (can be selected)
Temperature accuracy	<ul style="list-style-type: none"> • ISM: ± 1 digit • Analog: $\pm 0.25\text{ °C}$ ($\pm 32.5\text{ °F}$) within –30 to +150 °C (–22 to +302 °F); $\pm 0.50\text{ °C}$ ($\pm 32.9\text{ °F}$) outside
Temperature repeatability ¹⁾	$\pm 0.13\text{ °C}$ ($\pm 32.2\text{ °F}$)
Max. sensor cable length	<ul style="list-style-type: none"> • ISM: 80 m (260 ft) • Analog: 61 m (200 ft); with 4-e sensors: 15 m (50 ft)
Calibration	1-point, 2-point or process

1) ISM input signal causes no additional error.

pH/ORP

Measurement parameters	pH, mV and temperature
pH display range	- 2.00 to + 20.00 pH
pH resolution	Auto/0.001/0.01/0.1/1 (can be selected)
pH accuracy ¹⁾	Analog: ± 0.02 pH
mV range	- 1,500 to + 1,500 mV
mV resolution	Auto/0.001/0.01/0.1/1 mV (can be selected)
mV accuracy ¹⁾	Analog: ± 1 mV
Temperature input ²⁾	Pt1000/Pt100/NTC30K
Temperature measuring range	- 30 to 130 °C (- 22 to 266 °F)
Temperature resolution	Auto/0.001/0.01/0.1/1 (can be selected)
Temperature accuracy ¹⁾	Analog: ± 0.25 °C in the range of - 10 to + 150 °C (± 32.5 °F in the range of + 14 to + 176 °F)
Temperature repeatability ¹⁾	± 0.13 °C (± 32.2 °F)
Temperature compensation	Automatic/Manual
Max. sensor cable length	Analog: 10 to 20 m (33 to 65 ft) depending on sensor ISM: 80 m (260 ft)
Calibration	1-point (offset), 2-point (slope or offset) or process (offset)

1) ISM input signal causes no additional error.

2) Not required on ISM sensors.

Available Buffer Sets

Standard buffers	MT-9 buffers, MT-10 buffers, NIST Technical Buffers, NIST Standard Buffers (DIN 19266:2000-01), JIS Z 8802 buffers, Hach buffers, CIBA (94) buffers, Merck Titrisols-Reidel Fixanals, WTW buffers
Dual membrane electrode pH buffers (pH/pNa)	Mettler-pH/pNa buffers (Na+ 3.9M)

Amperometric oxygen

Measurement parameters	<ul style="list-style-type: none"> • Dissolved oxygen: Saturation or concentration and temperature • Oxygen in gas: Concentration and temperature
Current range	Analog: 0 to – 7,000 nA
Oxygen measuring ranges, dissolved oxygen	<ul style="list-style-type: none"> • Saturation: 0 to 500 % air, 0 to 200 % O₂ • Concentration: 0 ppb (µg/L) to 50.00 ppm (mg/L)
Oxygen measuring ranges, oxygen in gas	0 to 9,999 ppm O ₂ gas, 0 to 100 vol % O ₂
Oxygen accuracy, dissolved oxygen ¹⁾	<ul style="list-style-type: none"> • Saturation: ±0.5 % of the measured value or ±0.5 %, depending on which is larger • Concentration at high values: ±0.5 % of the measured value or ±0.050 ppm/±0.050 mg/L, depending on which is larger • Concentration at low values: ±0.5 % of the measured value or ±0.001 ppm/±0.001 mg/L, depending on which is larger • Concentration at traces values: ±0.5 % of the measured value or ±0.100 ppb/±0.1 µg/L, depending on which is larger
Oxygen accuracy, oxygen in gas ¹⁾	<ul style="list-style-type: none"> • ±0.5 % of the measured value or ±5 ppb, depending on which is larger for ppm O₂ gas • ±0.5 % of the measured value or ±0.01 %, depending on which is larger for vol % O₂
Resolution current ¹⁾	Analog: 6 pA
Polarization voltage	<ul style="list-style-type: none"> • Analog: – 1,000 to 0 mV • ISM: – 550 mV or – 674 mV (configurable)
Temperature input	NTC 22 kΩ, Pt1000, Pt100
Temperature compensation	Automatic
Temperature measuring range	– 10 to +80 °C (+ 14 to + 176 °F)
Temperature accuracy	±0.25 K in the range of – 10 to +80 °C (+ 14 to + 176 °F)
Max. sensor cable length	<ul style="list-style-type: none"> • Analog: 20 m (65 ft) • ISM: 80 m (260 ft)
Calibration	1-point (slope and offset) or process (slope and offset)

1) ISM input signal causes no additional error.

Optical oxygen

Measurement parameters	DO saturation or concentration and temperature
DO concentration range	0.1 ppb (µg/L) to 50.00 ppm (mg/L)
DO saturation range	0 to 500 % air, 0 to 100 % O ₂
DO resolution	Auto/0.001/0.01/0.1/1 (can be selected)
DO accuracy	±1 digit
Temperature measuring range	– 30 to + 150 °C (– 22 to + 302 °F)
Temperature resolution	Auto/0.001/0.01/0.1/1 (can be selected)
Temperature accuracy	± 1 digit
Temperature repeatability	± 1 digit
Temperature compensation	Automatic
Max. sensor cable length	15 m (50 ft)
Calibration	1-point (depending on sensor model), 2-point, process

Dissolved carbon dioxide

Measurement parameters	Dissolved carbon dioxide and temperature
CO ₂ measuring ranges	<ul style="list-style-type: none"> • 0 to 5,000 mg/L • 0 to 200 %sat • 0 to 1,500 mm Hg • 0 to 2,000 mbar • 0 to 2,000 hPa
CO ₂ accuracy	± 1 digit
CO ₂ resolution	Auto/0.001/0.01/0.1/1 (can be selected)
mV range	- 1,500 to + 1,500 mV
mV resolution	Auto/0.01/0.1/1 mV
mV accuracy	± 1 digit
Total pressure range (TotPres)	0 to 4,000 mbar
Temperature input	Pt1000/NTC22K
Temperature measuring range	0 to +60 °C (- 32 to + 140 °F)
Temperature resolution	Auto/0.001/0.01/0.1/1, (can be selected)
Temperature accuracy	± 1 digit
Temperature repeatability	± 1 digit
Max. sensor cable length	80 m (260 ft)
Calibration	1-point (offset), 2-point (slope or offset) or process (offset)

Available Buffer Sets

Buffer	MT-9 buffers with solution pH = 7.00 and pH = 9.21 @ 25 °C
--------	--

16.2 Electrical Specifications

16.2.1 General Electrical Specifications

Display	Backlit LCD, 4 lines
Running capacity	Ca. 4 days
Keypad	5 tactile feedback keys
Languages	8 (English, German, French, Italian, Spanish, Portuguese, Russian and Japanese)
Connection terminals	Spring cage terminals, appropriate for wire cross section 0.2 to 1.5 mm ² (AWG 16–24)
Analog input	4 to 20 mA (for pressure compensation)

16.2.2 4 to 20 mA (with HART®)

Supply voltage	14 to 30 V DC
Number of outputs (analog)	2
Current outputs	Loop current 4...20 mA, galvanically isolated up to 60 V from input and from earth/ground, protected against wrong polarity, feeding voltage 14 to 30 V DC
Measurement error through analog outputs	< ±0.05 mA over 1 to 20 mA range
Analog output configuration	Linear
PID process controller	Pulse length, pulse frequency
Hold input/Alarm contact	Yes/Yes (alarm delay 0 to 999 s)
Digital outputs	2 open collector (OC), 30 V DC, 100 mA, 0.9 W
Digital input	2, galvanically isolated up to 60 V from output, analog input and ground/ earth with switching limits 0.00 V DC to 1.00 V DC inactive 2.30 V DC to 30.00 V DC active
Alarm output delay	0 to 999 s

16.3 Mechanical Specifications

Dimensions	Housing –	144 × 144 × 116 mm
	Height × Width × Depth	(5.7 × 5.7 × 4.6 inch)
	Front bezel –	150 × 150 mm
	Height × Width	(5.9 × 5.9 inch)
	Max. depth – panel mounted	87 mm (excludes plug-in connectors)
Weight		1.50 kg (3.3 lb)
Material		Aluminum die cast
Enclosure rating		IP66/NEMA4X

16.4 Environmental Specifications

Storage temperature	– 40 to + 70 °C (– 40 to + 158 °F)
Ambient temperature operating range	– 20 to + 60 °C (– 4 to + 140 °F)
Relative humidity	0 to 95 % non-condensing
EMC	According to EN 61326-1 (general requirements) Emission: Class B, Immunity: Class A
Approvals and certificates	M400/2H <ul style="list-style-type: none"> • cFMus Class I, Division 2, Groups A, B, C, D T4A • cFMus Class I, Zone 2, Groups IIC T4 <hr/> M400/2XH, M400G/2XH <ul style="list-style-type: none"> • ATEX/IECEx/UKCA Zone 1 Ex ib [ia Ga] IIC T4 Gb • ATEX/IECEx/UKCA Zone 21 Ex ib [ia Da] IIIC T80 °C Db IP66 • cFMus Class I, Division 1, Groups A, B, C, D T4A • cFMus Class II, Division 1, Groups E, F, G • cFMus Class III • cFMus Class I, Zone 0, AEx ia IIC T4 Ga • NEPSI EX Zone
CE mark	The measuring system is in conformity with the statutory requirements of the EC Directives. METTLER TOLEDO confirms successful testing of the device by affixing to it the CE mark.

16.5 Control Drawings

16.5.1 Installation, Maintenance and Inspection

1. Intrinsically Safe Apparatus can be a source of ignition if internal spacings are shorted or connections opened.
2. Although intrinsically safe circuits are inherently low energy, they may still present a shock hazard because of the operating voltage.
3. Refer to manufacturer's written instructions before working on associated apparatus.
4. Inspection should be performed periodically to ensure that intrinsic safety has not been compromised. Inspections should include reviewing for unauthorized modifications, corrosion, accidental damage, change of flammable materials, and the effects of aging.
5. User replaceable parts of an intrinsically safe system should not be replaced with other than the manufacturer's direct equivalent.
6. Maintenance work may be performed on energized apparatus in hazardous areas subject to the conditions as follows:
 - Disconnection of, and removal or replacement of, items of electrical apparatus and cabling if such action will not result in shorting of different intrinsically safe circuits.
 - Adjustment of any control that is necessary for the calibration of the electrical apparatus or system.
 - Only test instruments specified in the written instructions should be used.
 - Performance of other maintenance activities specifically permitted by the relevant control drawing and instruction manual.
7. Maintenance of Associated Apparatus and parts of intrinsically safe circuits located in unclassified areas should be restricted to that described in a way such that electrical apparatus or parts of circuits remain interconnected with parts of intrinsically safe systems located in hazardous areas. Safety barrier ground connections should not be removed without first disconnecting the hazardous-area circuits.
8. Other maintenance work on Associated Apparatus or parts of an intrinsically safe circuit mounted in an unclassified area should be performed only if the electrical apparatus or part of a circuit is disconnected from the part of the circuit located in a hazardous area.
9. The location classification and the suitability of the intrinsically safe system for that classification should be verified. This includes verifying that the class, group, and temperature ratings of both the Intrinsically Safe Apparatus and the Associated Apparatus agree with the actual classification of the location.

10. Prior to energizing, an intrinsically safe system should be inspected to ensure the following:
- Installation is in compliance with the documentation;
 - Intrinsically safe circuits are properly separated from non-intrinsically safe circuits;
 - Cable shields are grounded in accordance with the installation documentation;
 - Modifications have been authorized;
 - Cables and wiring are not damaged;
 - Bonding and grounding connections are tight;
 - Bonding and grounding hardware is not corroded;
 - Resistance of any grounding conductor, including termination resistance from shunt-type-Associated Apparatus to the grounding electrode does not exceed one ohm;
 - Protection has not been defeated by bypassing; and
 - Check for signs of corrosion on the equipment and connections.
11. All deficiencies should be corrected.

16.5.2 Control Installation Drawing General Installation

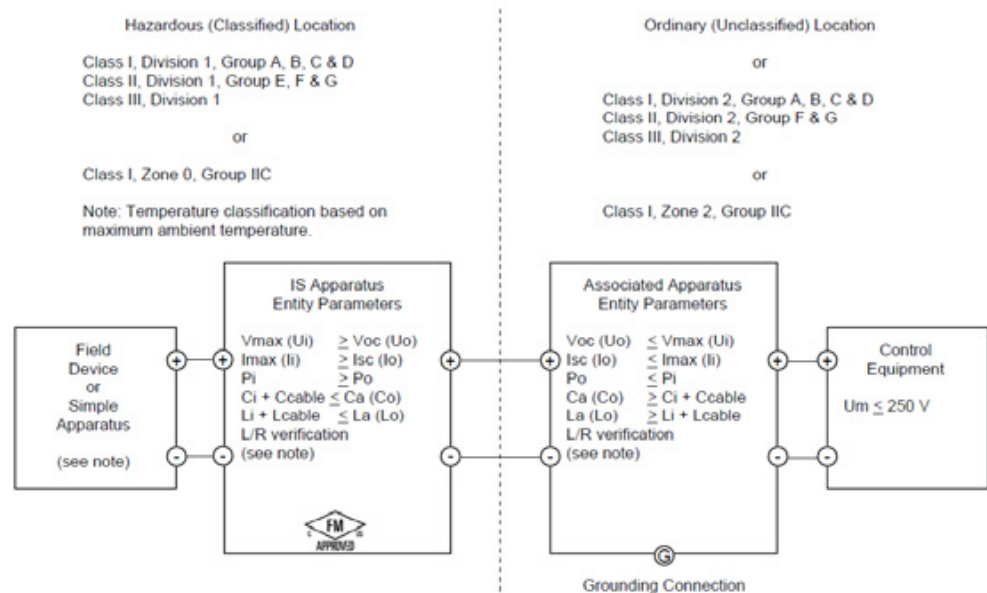

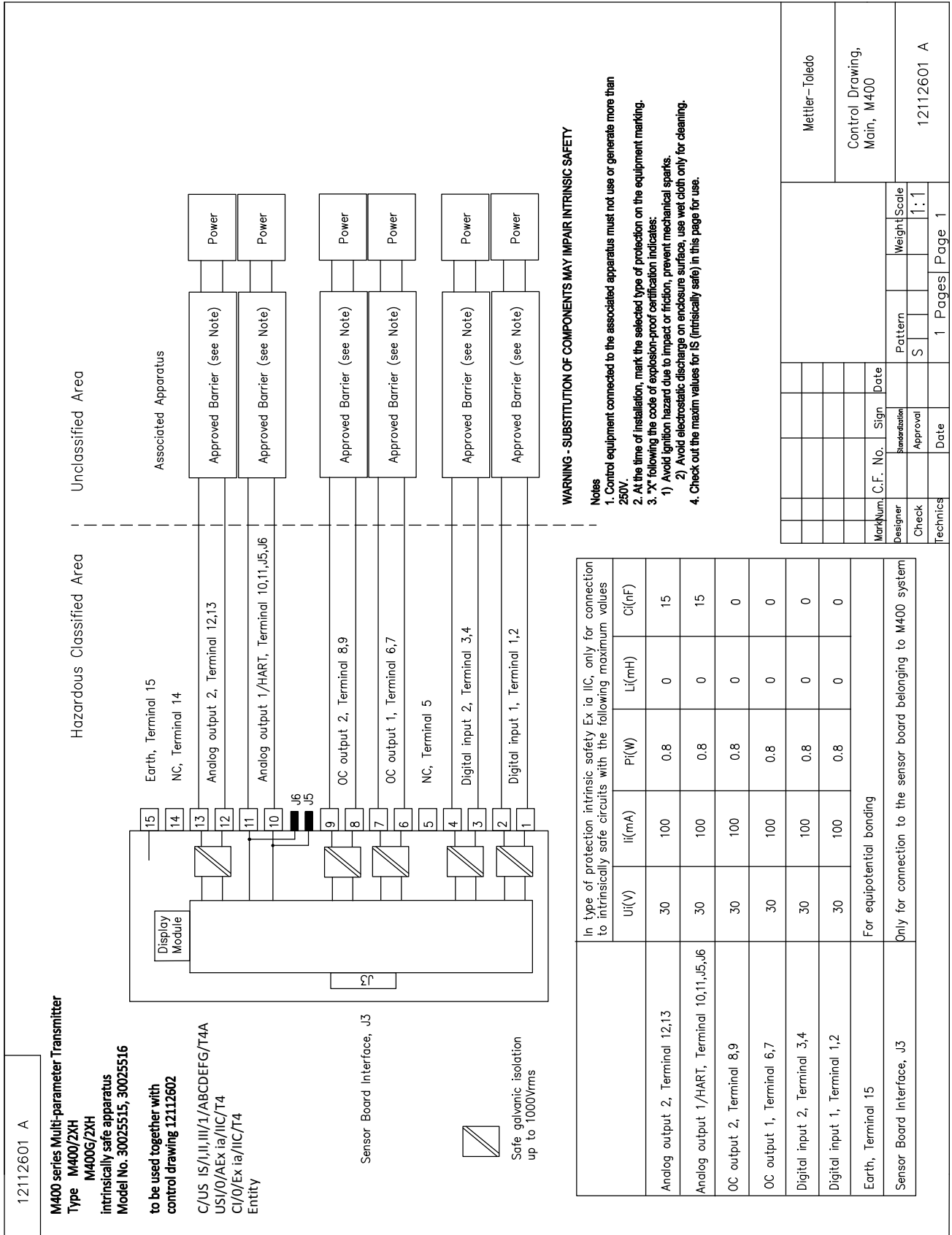

WARNING - SUBSTITUTION OF COMPONENTS MAY IMPAIR INTRINSIC SAFETY

- Notes**
1. Control equipment connected to the associated apparatus must not use or generate more than 250V.
 2. At the time of installation, mark the selected type of protection on the equipment marking.
 3. "X" following the code of explosion-proof certification indicates:
 - 1) Avoid ignition hazard due to impact or friction, prevent mechanical sparks.
 - 2) Avoid electrostatic discharge on enclosure surface, use wet cloth only for cleaning.
 4. Check out the maximum values for IS (intrinsically safe) in this page for use.

In type of protection intrinsic safety Ex ia IIC, only for connection to intrinsically safe circuits with the following maximum values		Ui(V)	Ii(mA)	Pi(W)	Li(mH)	Ci(nF)
Analog output 2, Terminal 12,13		30	100	0.8	0	15
Analog output 1/HART, Terminal 10,11,J5,J6		30	100	0.8	0	15
OC output 2, Terminal 8,9		30	100	0.8	0	0
OC output 1, Terminal 6,7		30	100	0.8	0	0
Digital input 2, Terminal 3,4		30	100	0.8	0	0
Digital input 1, Terminal 1,2		30	100	0.8	0	0
Earth, Terminal 15	For equipotential bonding					
Sensor Board Interface, J3	Only for connection to the sensor board belonging to M400 system					

MarkNum	C.F. No.	Sign	Date	Weight/Scale
Designer	Standardization	Approval	Date	1:1
Check				
Technics				
				1 Pages Page 1
Mettler-Toledo				
Control Drawing, Main, M400				
				12112601 A

12112602 A

**Hazardous Classified Area
Sensor Board
belonging to
M400 Multi-parameter Transmitters
control drawing 12112601 or 12112603**

Sensor interface	In type of protection intrinsic safety, only for connection to M400, with the following maximum values			
	U(V)	I(mA)	P(mW)	L(mH) C(µF)
pH measuring loop, Terminal A,E,G	Uo=5.88	Io=1.3	Po=1.9	Lo=5 Co=2.1
Conductivity measuring loop, Terminal A,B,E,G	Uo=5.88	Io=29	Po=43	Lo=1 Co=2.5
DO measuring loop, Terminal B,C,D,H	Uo=5.88	Io=29	Po=43	Lo=1 Co=2.5
Temperature measuring loop, Terminal I,J,K	Uo=5.88	Io=5.4	Po=8	Lo=5 Co=2
One-wire measuring loop, Terminal L,M	Uo=5.88	Io=22	Po=32	Lo=1 Co=2.8
485 measuring loop, Terminal N,O	Uo=5.88 Ui=30V	Io=54 Ii=100	Po=80 Pi=0.8	Lo=1 Li=0 Ci=0.7
Analog input measuring loop, Terminal P,Q	Ui=30	Ii=100	Pi=800	Li=0 Ci=0.015

The measuring circuits are galvanically connected.

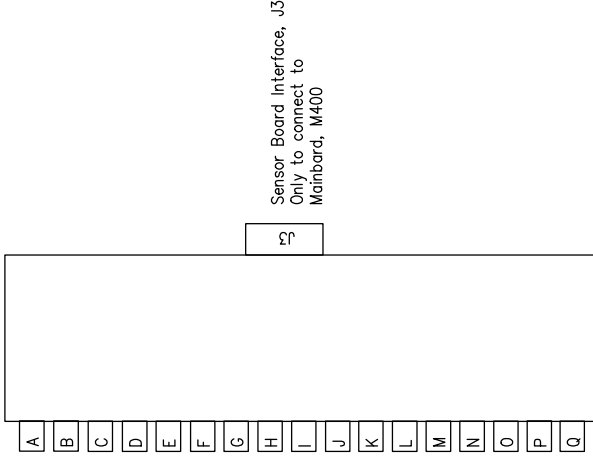

WARNING - SUBSTITUTION OF COMPONENTS MAY IMPAIR INTRINSIC SAFETY
WARNING - SUBSTITUTION OF COMPONENTS MAY IMPAIR THE SUITABILITY FOR ZONE 2

- Notes**
IECEX, ATEX, FM, CSA
1. When installed in M400, Intrinsically Safe Equipment connecting to A-Q must be approved or be a Simple Apparatus.
2. A Simple Apparatus is defined as a device that does not generates more than 1.5V, 0.1A or 25mW.
3. Check out the maxm values for IS (intrinsically safe) in this page for use.

MarkNum.	C.F. No.	Sign	Date	Pattern	Weight/Scale
Designer	Standardization	Approval	Date	S	1:1
Check				1	Pages
Technics				1	Page 1
				Mettler-Toledo Instruments (Shanghai) Co. Ltd.	
				Control Drawing, Sensor, M400	
				12112602 A	

16.5.3 Notes

1. The intrinsic safety entity concept allows the interconnection of FM Approved intrinsically safe devices with entity parameters not specifically examined in combination as a system when: $V_{oc} (U_o) \text{ or } V_f \leq V_{max}$, $I_{sc} (I_o) \text{ or } I_f \leq I_{max}$, $C_a (C_o) \geq C_i + C_{cable}$, $L_a (L_o) \geq L_i + L_{cable}$, $P_o \leq P_i$
2. The intrinsic safety fieldbus intrinsically safe concept allows the interconnection of FM Approved intrinsically safe devices with fieldbus intrinsically safe concept parameters not specifically examined in combination as a system when: $V_{oc} (U_o) \text{ or } V_f < V_{max}$, $I_{sc} (I_o) \text{ or } I_f \leq I_{max}$, $P_o \leq P_i$
3. The configuration of associated apparatus must be FM Approved under the entity concept.
4. Associated Apparatus manufacturer's installation drawing must be followed when installing this equipment.
5. The configuration of field device sensor must be FM Approved under the entity concept.
6. The installation must be in accordance with the National Electrical Code. (ANSI/NFPA 70 (NEC.)), Articles 504 and 505, and ANSI/ISA-RP12.06.01, or the Canadian Electrical (CE) Code. (CEC Part 1, CAN/CSA-C22.1), Appendix F, and ANSI/ISARP12.06.01 when installed in Canada.
7. A dust-tight conduit seal must be used when installed in Class II and Class III environments.
8. Control equipment connected to the associated apparatus must not use or generate more than the maximum unclassified location voltage, U_m , or 250 VAC/DC.
9. Resistance between intrinsically safe ground and earth ground must be less than one ohm.
10. For Class I, Zone 0 and Division 1 locations, installation of the Multi-parameter Transmitter M400/2(X)H, M400G/2XH, M400FF, M400PA should be in accordance with ANSI/ISA RP12.06.01 "Installation of Intrinsically Safe Systems for Hazardous (Classified) Locations" and the National Electrical Code. (ANSI/ NRPA 70), or Canadian Electrical (CE) Code. (CEC Part 1, CAN/CSA-C22.1) when installed in Canada.
11. The Multi-parameter Transmitter M400/2(X)H, M400G/2XH, M400FF, M400PA are FM Approved for Class I, Zone 0 and Division 1 applications. If connecting [AEx ib] or [Ex ib] associated apparatus to the Multiparameter Transmitter M400/2(X)H, M400G/2XH, M400FF, M400PA, the above system is only suitable for Class I, Zone 1, and is not suitable for Class I, Zone 0, or Division 1 hazardous (classified) locations.
12. For Division 2 installations, the associated apparatus is not required to be FM Approved under entity concept if the Multi-parameter Transmitter M400/2(X)H, M400G/2XH is installed in accordance with the National Electrical Code. (ANSI/NFPA 70), Articles 504 and 505 or Canadian Electrical (CE) Code., CAN/CSA-C22.1, Part 1, Appendix F, for Division 2 wiring methods excluding noncendive field wiring.
13. L_i may be greater than L_a and the cable length restrictions due to cable inductance (L_{cable}) can be ignored if both the following conditions are met: $L_a/R_a \text{ (or } L_o/R_o) > L_i/R_i$; $L_a/R_a \text{ (or } L_o/R_o) > L_{cable}/R_{cable}$
14. If the electrical parameters of the cable used are unknown, the following values may be used: Capacitance – 197 pF/m (60 pF/ft.); Inductance – 0.66 μ H/m (0.20 μ H/ft.)
15. Simple apparatus is defined as a device that does not generate more than 1.5 V, 0.1 A, or 25 mW.
16. No revision to the control installation drawing without prior authorization by FM Approvals.

17 Default Table

Common

Parameter	Sub parameter	Value	Unit
Alarm	OC	2	
	Delay	1	
	Hysterseis	0	
	State	Inverted	
	Power failure	No	
	Software failure	No	
	ChB disconnected	Yes	
Clean	OC	1	
	Hold mode	Hold	
	interval	0	
	Clean time	0	
	delay	0	
	hysteresis	0	
Hold outputs		Yes	
DigitalIn		Off	
Lockout		No	
ISM monitor	Lifetime indicator	Yes	Alarm Yes
	Time to maint	Yes	Alarm Yes
	Adapt Cal timer	Yes	Alarm Yes
	CIP cycle counter	100	Alarm Yes
	SIP cycle counter	100	Alarm Yes
	Autoclave cycle counter	0	Alarm No
	OC	None	
language		English	
Passwords	Administrator	00000	
	Operator	00000	
All OCs	Delay	10	sec
	Hysteresis	5	For measurement unit pH, mV, °C, the same unit. For other measurement unit, is %.
	State	normal	
	Hold mode	Last Value	
All analog out	Mode	4-20 mA	
	Type	Normal	
	Alarm	22.0 mA	
	Hold mode	Last value	
	Aout 1 damping	1 sec	

pH

Parameter	Sub parameter	Value	Unit
Channel X	A	pH	pH
	B	Temperature	°C
	C	None	
	D	None	
Temperature source (analog sensor)		Auto	
pH buffer		Mettler-9	
Drift Control		Auto	
IP		7.0 (ISM sensor reading from sensor)	pH
STC		0.000	pH/°C
Fix CalTemp		No	
Cal constants (for Analog sensor)	pH	S=100.0%,Z=7.000pH	
	Temperature	M=1.0, A=0.0	
Cal constants (for ISM sensor)		Read from sensor	
Resolution	pH	0.01	pH
	Temperature	0.1	°C
Analog outputs	1	A	
	2	B	
pH	Value 4 mA	2	pH
	value 20 mA	12	pH
temperature	Value 4 mA	0	°C
	value 20 mA	100	°C
Set point 1	Measurement	A	
	Type	off	
	OC	None	
Set point 2	Measurement	B	
	Type	Off	
	OC	None	
Alarm	Rg diagnostics	Yes	
	Rr diagnostics	Yes	

pH/pNa

Parameter	Sub parameter	Value	Unit
Channel X	A	pH	pH
	B	Temperature	°C
	C	None	
	D	None	
Temperature source (analog sensor)		Auto	
pH buffer		Na+ 3.9M	
Drift Control		Auto	
IP		Reading form sensor	pH
STC		0.000	pH/°C
Fix CalTemp		No	
Cal constants		Read from sensor	
Resolution	pH	0.01	pH
	Temperature	0.1	°C
Analog outputs	1	A	
	2	B	
pH	Value 4 mA	2	pH
	Value 20 mA	12	pH
temperature	Value 4 mA	0	°C
	Value 20 mA	100	°C
Set point 1	Measurement	A	
	Type	Off	
	OC	None	
Set point 2	Measurement	B	
	Type	Off	
	OC	None	
Alarm	Rg diagnostics	Yes	

Oxygen

Parameter	Sub parameter	Value	Unit
Channel X	A	O ₂	%Air (O ₂ low:ppb)
	B	Temperature	°C
	C	O ₂ (dual channel)	%Air (O ₂ low:ppb)
	D	Temperature (dual channel)	°C
Temperature source (analog sensor)		Auto	
CalPres)		759.8	mmHg
ProcPres)		759.8	mmHg
ProcCalPres		CaPres	
Drift control		Auto	
Salinity		0.0	g/Kg
Humidity		100	%
Umeaspol		Read from sensor	
Ucalpol		-674	mV
Cal constants (for Analog sensor)	O ₂ high:	S = -70.00 nA, Z = 0.00 nA	
	O ₂ low:	S = -350.00 nA, Z = 0.00 nA	
	Temperature	M = 1.0, A = 0.0	
Cal constants (for ISM sensor)		Read from sensor	
Resolution	O ₂	0.1	%Air
		1	ppb
	Temperature	0.1	°C
Analog outputs	1	A	
	2	B	
O ₂	Value 4 mA	0	%Air (O ₂ low:ppb)
	Value 20 mA	100	%Air (O ₂ low:ppb)
Temperature	Value 4 mA	0	°C
	Value 20 mA	100	°C
Set point 1	Measurement	A	
	Type	Off	
	OC	None	
Set point 2	Measurement	B	
	Type	Off	
	OC	None	
Alarm	Electrolyte low (ISM sensor)	Yes	

Resistivity/Conductivity

Parameter	Sub parameter	Value	Unit
Channel X	A	Resistivity	Ω -cm
	B	Temperature	$^{\circ}$ C
	C	None	
	D	None	
Temperature source (analog sensor)		Auto	
Compensation		Standard	
Cal constants (for analog sensor)	Cond/Res	M = 0.1, A = 0.0	
	Temperature	M = 1.0, A = 0.0	
Cal constants (for ISM sensor)		Read from sensor	
Resolution	Resistivity	0.01	Ω -cm
	Temperature	0.1	$^{\circ}$ C
Analog outputs	1	A	
	2	B	
Conductivity/Resistivity	Value 4 mA	10	M Ω -cm
	Value 20 mA	20	M Ω -cm
Temperature	Value 4 mA	0	$^{\circ}$ C
	Value 20 mA	100	$^{\circ}$ C
Set point 1	Measurement	A	
	Type	Off	
	OC	None	
Set point 2	Measurement	B	
	Type	Off	
	OC	None	
Alarm	Cond cell shorted	No	
	Dry cond sensor	No	
	Cell deviation (ISM sensor)	No	

CO₂

Parameter	Sub parameter	Value	Unit
Channel X	A	%CO ₂	%CO ₂
	B	Temperature	$^{\circ}$ C
	C	–	
	D	–	
pH buffer		Mettler-9	
Drift Control		Auto	
Salinity		28.0	g/L
HCO ₃		0.05	mol/L
TotPres		750.1	mmHg
Cal constants	CO ₂	Read from sensor	
Resolution	CO ₂	0.1	hPa
	Temperature	0.1	$^{\circ}$ C
Alarm	Rg diagnostics	No	

18 Warranty

METTLER TOLEDO warrants this product to be free from significant deviations in material and workmanship for a period of one year from the date of purchase. If repair is necessary and not the result of abuse or misuse within the warranty period, please return by freight pre-paid and amendment will be made without any charge. METTLER TOLEDO's Customer Service Dept. will determine if the product problem is due to deviations or customer abuse. Out-of-warranty products will be repaired on an exchange basis at cost.

The above warranty is the only warranty made by METTLER TOLEDO and is lieu of all other warranties, expressed or implied, including, without limitation, implied warranties of merchantability and fitness for a particular purpose. METTLER TOLEDO shall not be liable for any loss, claim, expense or damage caused by, contributed to or arising out of the acts or omissions of the Buyer or Third Parties, whether negligent or otherwise. In no event shall METTLER TOLEDO's liability for any cause of action whatsoever exceed the cost of the item giving rise to the claim, whether based in contract, warranty, indemnity, or tort (including negligence).

19 Buffer Tables

M400 transmitters have the ability to do automatic pH buffer recognition. The following tables show different standard buffers that are automatically recognized.

19.1 Standard pH Buffers

19.1.1 Mettler-9

Temp (°C)	pH of buffer solutions			
0	2.03	4.01	7.12	9.52
5	2.02	4.01	7.09	9.45
10	2.01	4.00	7.06	9.38
15	2.00	4.00	7.04	9.32
20	2.00	4.00	7.02	9.26
25	2.00	4.01	7.00	9.21
30	1.99	4.01	6.99	9.16
35	1.99	4.02	6.98	9.11
40	1.98	4.03	6.97	9.06
45	1.98	4.04	6.97	9.03
50	1.98	4.06	6.97	8.99
55	1.98	4.08	6.98	8.96
60	1.98	4.10	6.98	8.93
65	1.98	4.13	6.99	8.90
70	1.99	4.16	7.00	8.88
75	1.99	4.19	7.02	8.85
80	2.00	4.22	7.04	8.83
85	2.00	4.26	7.06	8.81
90	2.00	4.30	7.09	8.79
95	2.00	4.35	7.12	8.77

19.1.2 Mettler-10

Temp (°C)	pH of buffer solutions			
0	2.03	4.01	7.12	10.65
5	2.02	4.01	7.09	10.52
10	2.01	4.00	7.06	10.39
15	2.00	4.00	7.04	10.26
20	2.00	4.00	7.02	10.13
25	2.00	4.01	7.00	10.00
30	1.99	4.01	6.99	9.87
35	1.99	4.02	6.98	9.74
40	1.98	4.03	6.97	9.61
45	1.98	4.04	6.97	9.48
50	1.98	4.06	6.97	9.35
55	1.98	4.08	6.98	
60	1.98	4.10	6.98	
65	1.98	4.13	6.99	
70	1.99	4.16	7.00	
75	1.99	4.19	7.02	
80	2.00	4.22	7.04	
85	2.00	4.26	7.06	
90	2.00	4.30	7.09	
95	2.00	4.35	7.12	

19.1.3 NIST Technical Buffers

Temp (°C)	pH of buffer solutions				
0	1.67	4.00	7.115	10.32	13.42
5	1.67	4.00	7.085	10.25	13.21
10	1.67	4.00	7.06	10.18	13.01
15	1.67	4.00	7.04	10.12	12.80
20	1.675	4.00	7.015	10.07	12.64
25	1.68	4.005	7.00	10.01	12.46
30	1.68	4.015	6.985	9.97	12.30
35	1.69	4.025	6.98	9.93	12.13
40	1.69	4.03	6.975	9.89	11.99
45	1.70	4.045	6.975	9.86	11.84
50	1.705	4.06	6.97	9.83	11.71
55	1.715	4.075	6.97		11.57
60	1.72	4.085	6.97		11.45
65	1.73	4.10	6.98		
70	1.74	4.13	6.99		
75	1.75	4.14	7.01		
80	1.765	4.16	7.03		
85	1.78	4.18	7.05		
90	1.79	4.21	7.08		
95	1.805	4.23	7.11		

19.1.4 NIST Standard Buffers (DIN and JIS 19266: 2000–01)

Temp (°C)	pH of buffer solutions			
0				
5	1.668	4.004	6.950	9.392
10	1.670	4.001	6.922	9.331
15	1.672	4.001	6.900	9.277
20	1.676	4.003	6.880	9.228
25	1.680	4.008	6.865	9.184
30	1.685	4.015	6.853	9.144
37	1.694	4.028	6.841	9.095
40	1.697	4.036	6.837	9.076
45	1.704	4.049	6.834	9.046
50	1.712	4.064	6.833	9.018
55	1.715	4.075	6.834	8.985
60	1.723	4.091	6.836	8.962
70	1.743	4.126	6.845	8.921
80	1.766	4.164	6.859	8.885
90	1.792	4.205	6.877	8.850
95	1.806	4.227	6.886	8.833



NOTE: The pH(S) values of the individual charges of the secondary reference materials are documented in a certificate of an accredited laboratory. This certificate is supplied with the respective buffer materials. Only these pH(S) values shall be used as standard values for the secondary reference buffer materials. Correspondingly, this standard does not include a table with standard pH values for practical use. The table above only provides examples of pH(PS) values for orientation.

19.1.5 Hach Buffers

Buffer values up to 60 °C as specified by Bergmann & Beving Process AB.

Temp (°C)	pH of buffer solutions		
0	4.00	7.14	10.30
5	4.00	7.10	10.23
10	4.00	7.04	10.11
15	4.00	7.04	10.11
20	4.00	7.02	10.05
25	4.01	7.00	10.00
30	4.01	6.99	9.96
35	4.02	6.98	9.92
40	4.03	6.98	9.88
45	4.05	6.98	9.85
50	4.06	6.98	9.82
55	4.07	6.98	9.79
60	4.09	6.99	9.76

19.1.6 Ciba (94) Buffers

Temp (°C)	pH of buffer solutions			
0	2.04	4.00	7.10	10.30
5	2.09	4.02	7.08	10.21
10	2.07	4.00	7.05	10.14
15	2.08	4.00	7.02	10.06
20	2.09	4.01	6.98	9.99
25	2.08	4.02	6.98	9.95
30	2.06	4.00	6.96	9.89
35	2.06	4.01	6.95	9.85
40	2.07	4.02	6.94	9.81
45	2.06	4.03	6.93	9.77
50	2.06	4.04	6.93	9.73
55	2.05	4.05	6.91	9.68
60	2.08	4.10	6.93	9.66
65	2.07 ¹⁾	4.10 ¹⁾	6.92 ¹⁾	9.61 ¹⁾
70	2.07	4.11	6.92	9.57
75	2.04 ¹⁾	4.13 ¹⁾	6.92 ¹⁾	9.54 ¹⁾
80	2.02	4.15	6.93	9.52
85	2.03 ¹⁾	4.17 ¹⁾	6.95 ¹⁾	9.47 ¹⁾
90	2.04	4.20	6.97	9.43
95	2.05 ¹⁾	4.22 ¹⁾	6.99 ¹⁾	9.38 ¹⁾

1) Extrapolated.

19.1.7 Merck Titrisole, Riedel-de-Haën Fixanale

Temp (°C)	pH of buffer solutions				
0	2.01	4.05	7.13	9.24	12.58
5	2.01	4.05	7.07	9.16	12.41
10	2.01	4.02	7.05	9.11	12.26
15	2.00	4.01	7.02	9.05	12.10
20	2.00	4.00	7.00	9.00	12.00
25	2.00	4.01	6.98	8.95	11.88
30	2.00	4.01	6.98	8.91	11.72
35	2.00	4.01	6.96	8.88	11.67
40	2.00	4.01	6.95	8.85	11.54
45	2.00	4.01	6.95	8.82	11.44
50	2.00	4.00	6.95	8.79	11.33
55	2.00	4.00	6.95	8.76	11.19
60	2.00	4.00	6.96	8.73	11.04
65	2.00	4.00	6.96	8.72	10.97
70	2.01	4.00	6.96	8.70	10.90
75	2.01	4.00	6.96	8.68	10.80
80	2.01	4.00	6.97	8.66	10.70
85	2.01	4.00	6.98	8.65	10.59
90	2.01	4.00	7.00	8.64	10.48
95	2.01	4.00	7.02	8.64	10.37

19.1.8 WTW Buffers

Temp (°C)	pH of buffer solutions			
0	2.03	4.01	7.12	10.65
5	2.02	4.01	7.09	10.52
10	2.01	4.00	7.06	10.39
15	2.00	4.00	7.04	10.26
20	2.00	4.00	7.02	10.13
25	2.00	4.01	7.00	10.00
30	1.99	4.01	6.99	9.87
35	1.99	4.02	6.98	9.74
40	1.98	4.03	6.97	9.61
45	1.98	4.04	6.97	9.48
50	1.98	4.06	6.97	9.35
55	1.98	4.08	6.98	
60	1.98	4.10	6.98	
65	1.99	4.13	6.99	
70		4.16	7.00	
75		4.19	7.02	
80		4.22	7.04	
85		4.26	7.06	
90		4.30	7.09	
95		4.35	7.12	

19.1.9 JIS Z 8802 Buffers

Temp (°C)	pH of buffer solutions			
0	1.666	4.003	6.984	9.464
5	1.668	3.999	6.951	9.395
10	1.670	3.998	6.923	9.332
15	1.672	3.999	6.900	9.276
20	1.675	4.002	6.881	9.225
25	1.679	4.008	6.865	9.180
30	1.683	4.015	6.853	9.139
35	1.688	4.024	6.844	9.102
38	1.691	4.030	6.840	9.081
40	1.694	4.035	6.838	9.068
45	1.700	4.047	6.834	9.038
50	1.707	4.060	6.833	9.011
55	1.715	4.075	6.834	8.985
60	1.723	4.091	6.836	8.962
70	1.743	4.126	6.845	8.921
80	1.766	4.164	6.859	8.885
90	1.792	4.205	6.877	8.850
95	1.806	4.227	6.886	8.833

19.2 Dual Membrane pH Electrode Buffers

19.2.1 Mettler-pH/pNa Buffers (Na+ 3.9M)

Temp (°C)	pH of buffer solutions			
0	1.98	3.99	7.01	9.51
5	1.98	3.99	7.00	9.43
10	1.99	3.99	7.00	9.36
15	1.99	3.99	6.99	9.30
20	1.99	4.00	7.00	9.25
25	2.00	4.01	7.00	9.21
30	2.00	4.02	7.01	9.18
35	2.01	4.04	7.01	9.15
40	2.01	4.05	7.02	9.12
45	2.02	4.07	7.03	9.11
50	2.02	4.09	7.04	9.10

For addresses of METTLER TOLEDO
Market Organizations please go to:
www.mt.com/contacts

www.mt.com/pro

For more information



Management System
certified according to
ISO 9001/ISO 14001



METTLER TOLEDO Group

Process Analytics
Local contact: www.mt.com/contacts

Subject to technical changes
© 02/2023 METTLER TOLEDO
All rights reserved
Printed in Switzerland. 30 031 683 G

